



SERRANO SUMMIT

FINAL
AREA PLAN



November 2016

SERRANO SUMMIT

AREA PLAN

NOVEMBER 2016

FINAL

Lead Agency:

City of Lake Forest

25550 Commercentre Drive, Suite 100
Lake Forest, CA 92630
949.461.3400

Prepared by:

KTGY Group, Inc.

17911 Von Karman Ave, #200
Irvine, CA 92614
949.851.2133
Contact: Jason Gavin

Owner:

Irvine Ranch Water District

15600 Sand Canyon Avenue
Irvine, CA 92618
949.453.5358
Contact: Rob Jacobson

In Association with:

Fusco Engineering

16795 Von Karman, Suite 100
Irvine, CA 92606
949.474.1960
Contact: Trevor Dodson, P.E

Owner's Representative:

Lewis Operating Corp

1156 N. Mountain Avenue
P.O. Box 670
Upland, CA 91785-0670
909.579.1291
Contact: Omar Dandashi

Sitescapes, Inc.

3190 B Airport Loop Drive
Costa Mesa, CA 92626
949.644.9370
Contact: Rick Polhamus

Firesafe Planning Solutions

302 N. El Camino Real, Suite 202
San Clemente, CA 92672
949.240-5911
Contact: David Oatis

TABLE OF CONTENTS

Section 1 - Executive Summary

1.1	Overview	1-1
1.2	Purpose of the Area Plan	1-4
1.3	Community Vision	1-4
1.4	Land Use	1-8
1.5	Serrano Summit Identity	1-10
1.6	Development Plan	1-11
1.7	Governing Documents	1-11
1.8	Area Plan Components	1-12

Section 2 - Introduction

2.1	Area Plan Overview	2-1
2.2	Project Setting	2-2
2.3	Area Plan Goals & Objectives	2-3
2.4	Area Plan Summary	2-5
2.5	Authority & Requirements of the Area Plan	2-7
2.6	Development Approval Components	2-8
2.7	CEQA Compliance	2-9
2.8	Severability	2-9

Section 3 - Existing Conditions

3.1	Site & Local History	3-1
3.2	Property Ownerships	3-1
3.3	Surrounding Land Uses	3-3
3.4	Physical Site Features	3-3
3.5	Existing Circulation & Infrastructure	3-7
3.6	Schools	3-10

Section 4 - Plan Elements

4.1	Introduction	4-1
4.2	Community Theme	4-1
4.3	Community Design	4-4
4.4	Plan Elements	4-7

Section 5 - Infrastructure - Public Facilities & Services

5.1	Domestic Water	5-1
5.2	Reclaimed Water	5-2
5.3	Sewer	5-3

5.4	Drainage	5-3
5.5	Water Quality	5-8
5.6	Grading	5-10
5.7	Community Facilities	5-16
5.8	Technology Plan	5-17

Section 6 - Circulation

6.1	Circulation	6-1
-----	-------------------	-----

Section 7 - Residential Design Guidelines

7.1	Design Guideline Introduction	7-1
7.2	Community Recreation & Common Facilities	7-3
7.3	Neighborhood Planning Design Guidelines	7-4
7.4	Architectural Design Guidelines	7-10
7.5	Green Builder Program	7-21

Section 8 - Civic Center Design Guidelines

8.1	General Guidelines for the Civic Center	8-1
8.2	Civic Center Plaza Design	8-5
8.3	Civic Center Landscaping	8-7
8.4	Civic Center Signage	8-9
8.5	Bus Shelters in Civic Center Area	8-11
8.6	Walls & Fences in Civic Center Area	8-11
8.7	Civic Center Area Lighting	8-13
8.8	Civic Center Green Building Standards	8-14

Section 9 - Landscape Design Guidelines

9.1	Community Landscape	9-1
9.2	Landscape Theme	9-1
9.3	General Landscape Criteria	9-7
9.4	Irrigation Practices & Design	9-9
9.5	Landscape Tree Districts	9-10
9.6	Tiered Landscape Program	9-12
9.7	Streetscape Design	9-13
9.8	Community & Neighborhood Entries and Monumentation	9-28
9.9	Residential Landscape Design	9-36
9.10	Community Trail	9-39
9.11	Neighborhood Parks	9-40
9.12	Lighting Design & Practices	9-47
9.13	Walls & Fences	9-48
9.14	Site Furniture	9-54
9.15	Fuel Modification	9-55
9.16	Master Plant Palette	9-59

Section 10 - Development Regulations

10.1	Introduction	10-1
10.2	Definition of Terms	10-1
10.3	Administration	10-1
10.4	General Provisions	10-2
10.5	Sustainability Development Regulations	10-3
10.6	Residential District Standards	10-4
10.7	Agriculture (P.A. 18 & P.A. 19) and P.A. 13 (Public Facilities Overlay) Standards	10-20
10.9	Signage	10-24
10.10	Lighting	10-24
10.11	Site Furnishings	10-25
10.12	Bus Turnouts & Shelters	10-25
10.13	Mailboxes	10-25
10.14	Model Home Development Standards	10-26

Section 11 - Implementation

11.1	Overview	11-1
11.2	Interpretation	11-1
11.3	Severability	11-1
11.4	Development Density	11-2
11.5	Development Agreement	11-2
11.6	Implementation of Development Regulations	11-2
11.7	Implementation of Design Guidelines	11-3
11.8	Development Review & Approval Process	11-3
11.9	Model Home Complex Permit	11-4
11.10	Transfer of Residential Dwelling Units	11-4
11.11	Adjustments to a Planning Area	11-5
11.12	Minor Modifications & Area Plan Amendments	11-5
11.13	Appeals	11-6
11.14	CEQA	11-6
11.15	Project Financing	11-7
11.16	Project Phasing	11-7
11.17	Maintenance	11-10
11.18	Conformity Review	11-13

Section 12 - Relationship to the General Plan

12.1	Area Plan Consistency with the General Plan	12-1
------	---	------

TABLE OF EXHIBITS

Exhibit 1-1	Regional Location Map	1-2
Exhibit 1-2	Vicinity Map	1-3
Exhibit 1-3	Public Activities Linkage Diagram	1-6
Exhibit 1-4	Community Arrival Sequence	1-7
Exhibit 1-5	Master Land Use Plan	1-9
Exhibit 3-1	Existing Land Uses	3-2
Exhibit 3-2	Surrounding Land Uses	3-4
Exhibit 3-3	Existing Site Topography	3-5
Exhibit 3-4	Site Opportunities & Constraints	3-6
Exhibit 3-5	Existing Infrastructure	3-9
Exhibit 4-1	Master Land Use Plan	4-6
Exhibit 4-2	Master Plan of Parks, Trails & Open Space	4-10
Exhibit 5-1	Water Master Plan	5-4
Exhibit 5-2	Reclaimed Water Master Plan	5-5
Exhibit 5-3	Sewer Master Plan	5-6
Exhibit 5-4	Drainage Master Plan	5-7
Exhibit 5-5	Water Quality Master Plan	5-9
Exhibit 5-6	Grading Concept Plan	5-12
Exhibit 5-7	Site-Wide Grading Cross Sections	5-13
Exhibit 5-8	3-D Grading Model	5-14
Exhibit 5-9	Joint Trench Master Plan	5-15
Exhibit 6-1	Circulation Plan	6-3
Exhibit 6-2	'A' Street Plan View & Section	6-5
Exhibit 6-3	'B' Street Plan View & Section	6-6
Exhibit 6-4	Indian Ocean Drive Plan View & Section	6-7
Exhibit 6-5	'D' Street Plan View & Section (Private)	6-8
Exhibit 6-6	Private Local Street Plan View & Section	6-9
Exhibit 6-7	Private Alley Drive Plan View & Section - Single Family Residential	6-10
Exhibit 6-8	Private Alley Drive Plan View & Section - Townhome	6-11
Exhibit 6-9	Roundabout at 'A' Street & 'B' Street	6-12
Exhibit 6-10	Roundabout at 'B' Street & Indian Ocean Drive	6-13
Exhibit 9-1	Community Landscape Features	9-3
Exhibit 9-2	Conceptual Landscape Master Plan	9-5
Exhibit 9-3	Landscape Tree District Plan	9-11
Exhibit 9-4	'A' Streetscape	9-17
Exhibit 9-5	'B' Streetscape	9-19

Exhibit 9-6	Indian Ocean Drive Streetscape	9-21
Exhibit 9-7	'D' Streetscape (Private)	9-23
Exhibit 9-8	Private Local Street Streetscape	9-25
Exhibit 9-9	Private Alley Drive Streetscape - Single Family Residential	9-26
Exhibit 9-10	Private Alley Drive Streetscape - Townhome	9-27
Exhibit 9-11	Community Entry & Monumentation at Street 'A'	9-31
Exhibit 9-12	Community Entry & Monumentation at Indian Ocean Drive	9-33
Exhibit 9-13	Iconic Intersection	9-34
Exhibit 9-14	Neighborhood Entry & Monumentation	9-35
Exhibit 9-15	Neighborhood Park Design (Planning Area 15)	9-41
Exhibit 9-16	Neighborhood Park Design (Planning Area 16)	9-42
Exhibit 9-17	Passive / Nature Park Design (Planning Area 17)	9-43
Exhibit 9-18	Recreational Center Design (Planning Area 14)	9-45
Exhibit 9-19	Fence & Wall Plan	9-51
Exhibit 9-20	Pilaster / Rail Fence	9-53
Exhibit 9-21	Fuel Modification Plan	9-57
Exhibit 11-1	Public Facilities Phasing & Financing Plan	11-8
Exhibit 11-2	Development Phasing Plan	11-9
Exhibit 11-3	Maintenance Responsibilities	11-12

TABLE OF APPENDICES

Appendix - Architectural Style Sheets

An Introduction To Architectural Styles.....	A-1
Monterey	A-2
Santa Barbara	A-3
Spanish Colonial	A-4
An Introduction To The Revival Style	A-5
Adobe Ranch - Revival Series	A-6
Spanish Colonial - Revival Series.....	A-7

EXECUTIVE SUMMARY

Section 1.0

November 2016



“Remember the Past, Challenge the Future”

City of Lake Forest’s Motto

OVERVIEW

1.1

The Serrano Summit Area Plan is a comprehensive plan for the development of approximately 98.9 acres located within the City of Lake Forest, California. Serrano Summit is located north of existing residential uses in Serrano Highlands, south of Commercentre Drive and existing industrial uses at the current terminus of Biscayne Bay Drive, east of Bake Parkway, and west of Serrano Creek. Vehicular access to the site is available via both Indian Ocean Drive and Biscayne Bay Drive. The regional and local context of Serrano Summit is illustrated on Exhibit 1-1, “Regional Location Map,” and Exhibit 1-2, “Vicinity Map.”

Serrano Summit provides for development of a new community of residential neighborhoods combined with parks and recreation areas, neighborhood gathering places, a new Civic Center site, and existing and future Public Facilities.



View from Project Site Looking Northeast at Saddleback Mountains



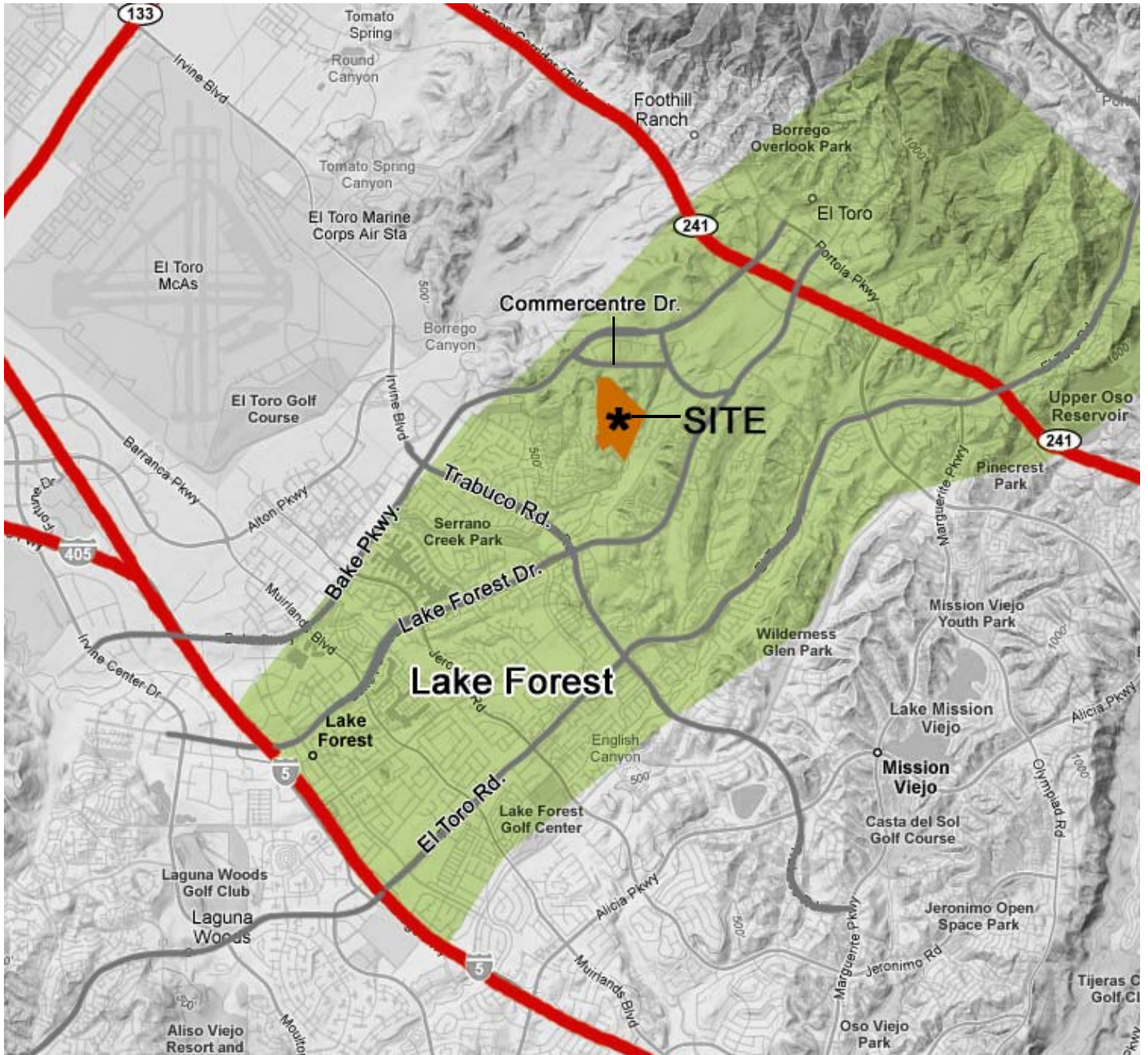

PURPOSE OF THE AREA PLAN

1.2

The Serrano Summit Area Plan establishes the regulations and guidelines which will govern development of Serrano Summit. The Area Plan implements the City of Lake Forest General Plan goals and policies established for the project area and establishes the zoning regulations for the community. Where the regulations of the Area Plan vary from the City of Lake Forest zoning regulations for the project area, the provisions of the Serrano Summit Area Plan shall prevail.

COMMUNITY VISION

1.3

Serrano Summit is a 98.9-acre master planned community located in the northwest portion of Lake Forest, California. This elevated setting has long range views to the west and south, where the Pacific Ocean is visible on a clear day. The site is located immediately adjacent to the Serrano Creek and regional trail – its most prominent natural feature from which the community derives its name and primary thematic inspiration.

Community Design Goals and Principles

Serrano Summit has been planned based on the fundamental principles of good community form, a logical pattern of organization, and the site's unique natural form givers. To ensure the successful interpretation and implementation of these ideas, the community design goals and principles have been distilled down to the following four primary principles:

- Create a Distinctive Place
- Connect With Nature
- Capture Views
- Provide a Social Heart

Create a Distinctive Place

Enhance the intrinsic value of the community through creation of distinctive, quality neighborhoods that differ from the disconnected subdivision models of the recent past. Promote design in architecture, landscape and neighborhood planning to establish a visually exceptional environment. Create long term value and community pride for future residents and homeowners and the City of Lake Forest.

Connect With Nature

The open space near the site is viewed as a valuable - and value-added - amenity that should be connected to the community's daily life and identity.

Capture Views

Orient all structures and public spaces to take the greatest advantage of the long range views available from the site.

Provide a Social Heart

Establish a community-wide armature of public activities, active and passive parks, and engaging places that provide opportunities for recreation and private reflection. Exhibit 1-3 provides a general organization diagram of the primary connections

between the community's destinations, and should be integrated in the design of all residential neighborhoods through the combined use of building orientation, a multi-purpose trail, paseos or sidewalks.

Major Framework Elements

To create a physical plan that manifests the community design goals and principles, a set of major framework elements and structures was established which defines critical relationships and organizing criteria. These broadly defined elements are:

Circulation and Site Design

Organize buildings and circulation based on the community's cross axial orientation (as shown on Exhibit 1-3, "Public Activities Linkage Diagram"). Maintain a predictable, logical and efficient grid pattern of organization that fits the shape and geometry of the project's development envelope.

Community Arrival Sequence

To enhance the experience of entering a unique and special place, implement the design elements and principles established by the Community Arrival Sequence Plan (as detailed on Exhibit 1-4).

The Central Spine Street / Iconic Building Placement

The design characteristics of 'B' Street have been developed to provide a pleasant walking experience along the prominent central spine of the community. Homes along 'B' Street will be oriented fronting the street and connecting front doors directly to the streets sidewalk.

The visual terminus planned for both ends of the Central Spine Street will be established through the placement of public buildings. The Community Recreation Building is located at the western terminus of 'B' Street, while the eastern terminus serves as the location of the planned City of Lake Forest Civic Center (as depicted on Exhibit 1-5, "Master Land Use Plan"). Roundabouts at each end of 'B' Street will further add to the street's striking visual attraction in addition to providing traffic-calming benefits.

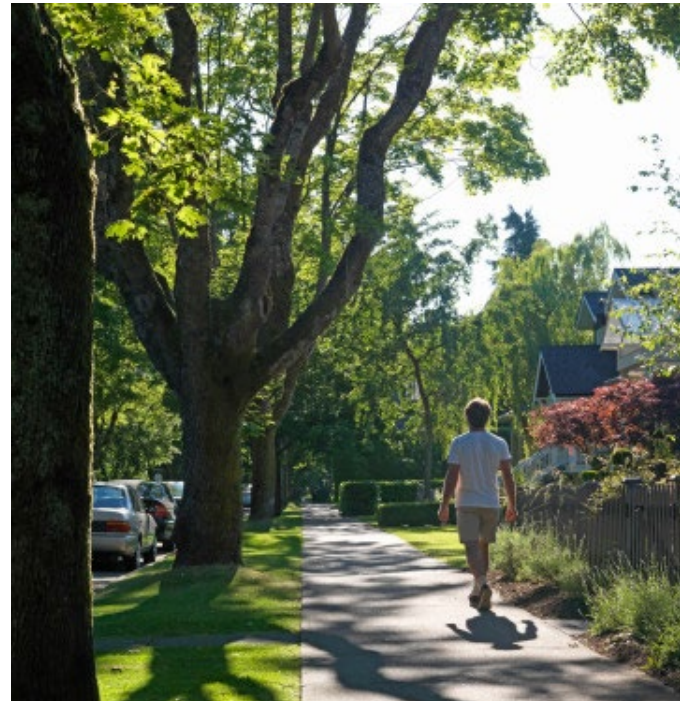

PUBLIC ACTIVITIES LINKAGE DIAGRAM

EXHIBIT 1-3



N.T.S. 

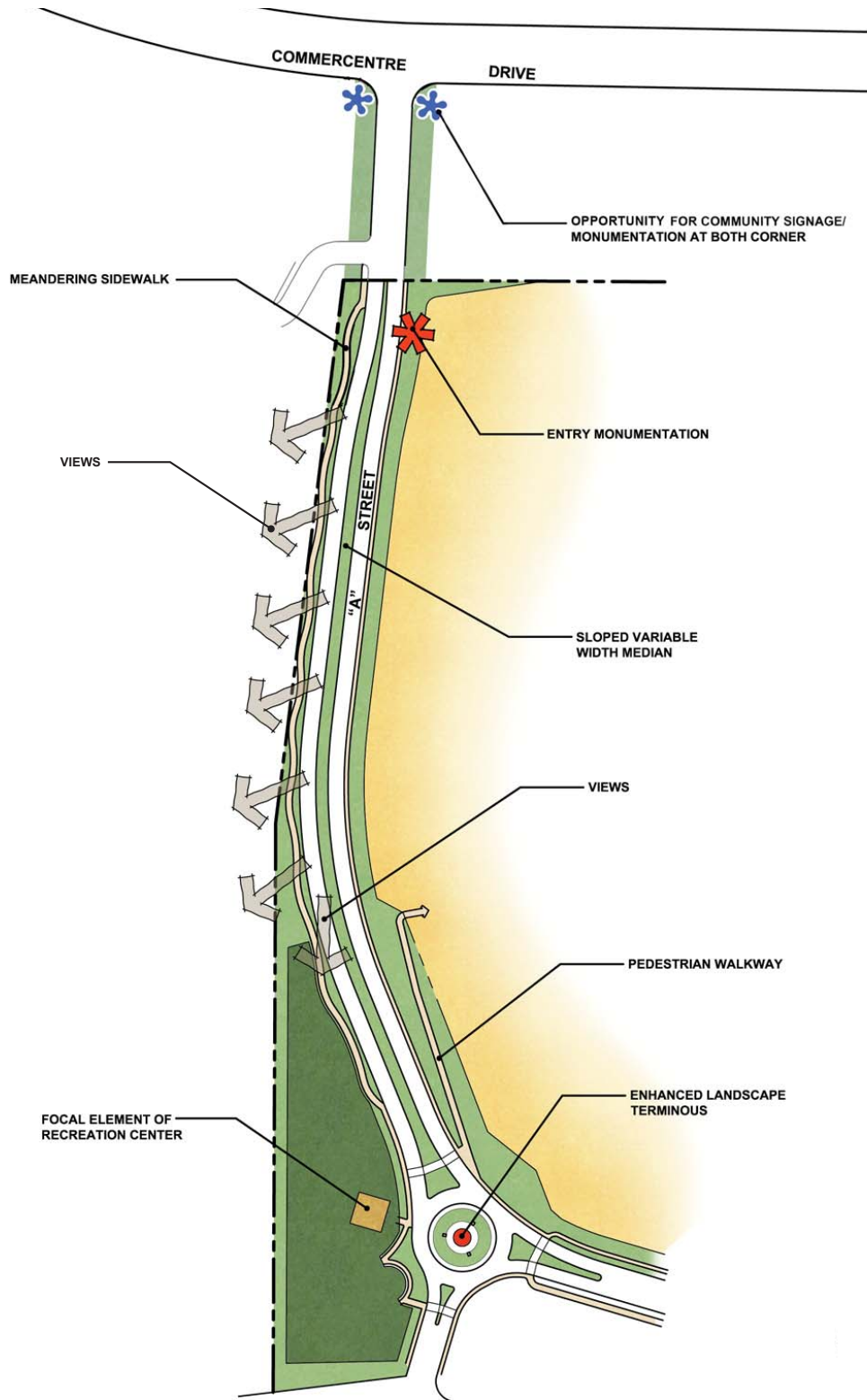

LAND USE

1.4

The Area Plan contains provisions which ensure that land uses are arranged in keeping with the guiding principles of design, as well as the geographical features and environmental character of Serrano Summit as follows:

- A human scale of development is planned, providing pedestrian connectivity within the community through paseos and pedestrian linkages.
- Providing an array of housing types that address a variety of market segments.
- Design of residential neighborhoods oriented to long views, parks and open space areas that promote an outdoor lifestyle with active and passive recreational opportunities for its residents.
- Residential neighborhoods located within easy walking distance to parks and open space areas.
- Public Facilities that provide services to the area, while sufficiently separated from the residential community.

Streets

Collector and local streets form the circulation system for the community providing for the efficient movement of vehicles through the community and via a system of pedestrian linkages. The project street system incorporates the following features:

- Streets that include expanded landscaped parkways and sidewalks separated from the street to create an intimate environment promoting alternative forms of transportation.
- Traffic calming features integrated into the design of the circulation system including two roundabouts to reduce traffic speeds.
- Bicyclists may use all public and private streets including 'A' Street, 'B' Street, 'D' Street (private), 'E' Street (private), and Indian Ocean Drive.

Residential Architecture & Site Planning

Serrano Summit will promote diverse and varied architecture combined with comprehensive site planning to produce the following:

- Residential neighborhoods designed with varied housing types and architectural styles.
- Streets linked together in a manner friendly to pedestrians while being accessible to bicycles and automobiles, that connect neighborhoods to parks, open space, public uses, and recreational areas.

Refer to Section 7, "Residential Design Guidelines," for a discussion of residential architecture permitted within the Serrano Summit boundaries.

Civic Center Architecture & Site Planning

Serrano Summit includes a Civic Center on-site located within convenient access of project area residents by biking or walking.

- The Civic Center site will be easily accessible from Commercentre Drive via Indian Ocean Drive.
- The Civic Center will be designed to serve as the visual terminus of 'B' Street, which will be designed to create a sense of arrival.
- Provision is made for pedestrian linkages connecting the residential neighborhoods on-site with the Civic Center, and the Civic Center with nearby open space areas, and the Serrano Creek Trail.
- The Civic Center complex will provide gathering space(s) for social interaction.







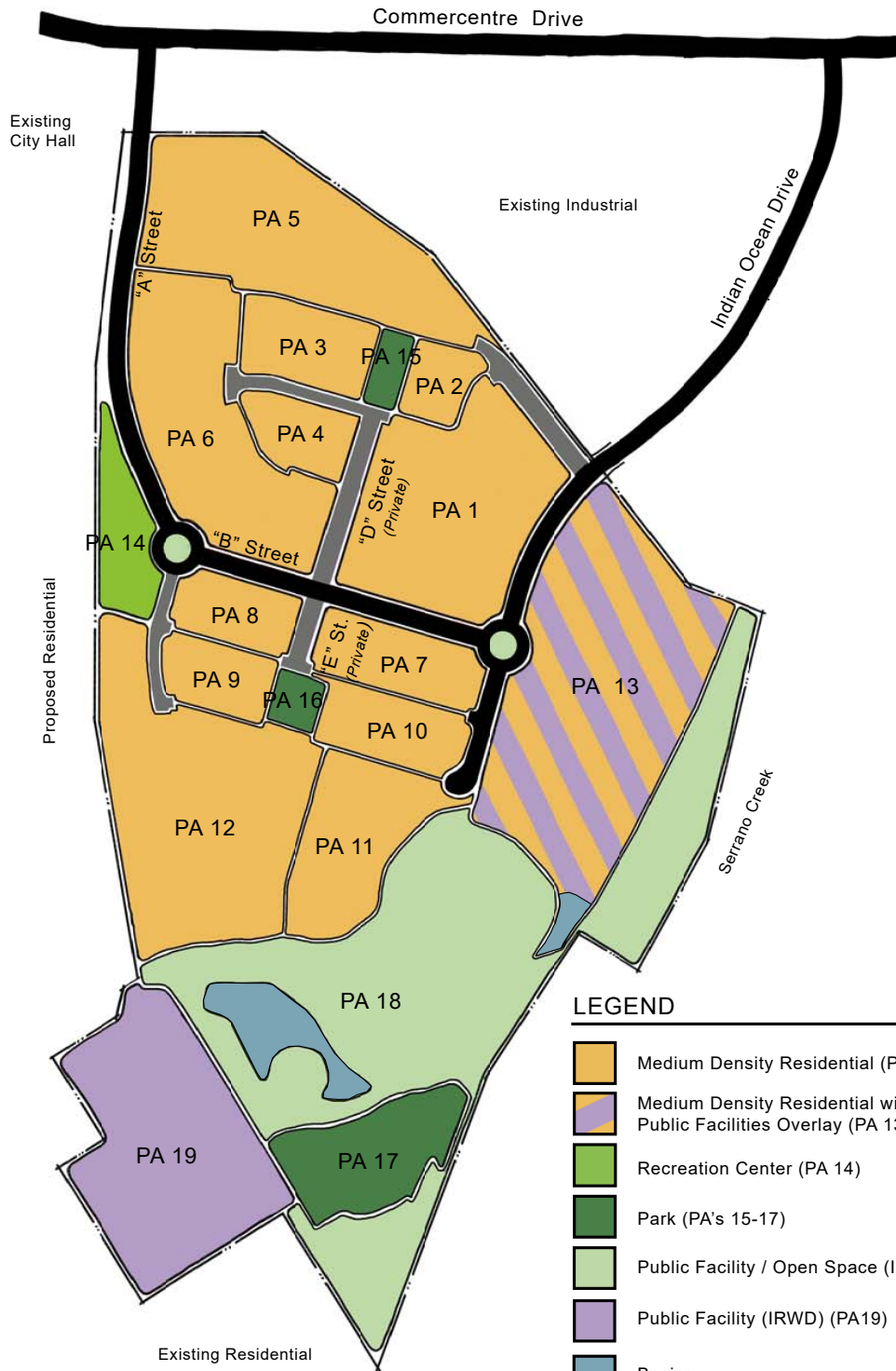

Sustainable Design

Serrano Summit is designed as a community founded on the principles of sustainable design. Sustainable features of Serrano Summit shall promote the following:

- The use of climate-appropriate plant materials and non-invasive ornamental landscape materials utilized as the primary plant materials for streetscape, public open space and trail.
- Residential development connected to the open space areas within the community by linkages promoting walking and bicycling as a feasible alternative to automobile travel.



LEGEND

-  Medium Density Residential (PA's 1-12)
-  Medium Density Residential with Public Facilities Overlay (PA 13)
-  Recreation Center (PA 14)
-  Park (PA's 15-17)
-  Public Facility / Open Space (IRWD) (PA 18)
-  Public Facility (IRWD) (PA19)
-  Basins
-  Public Street
-  Private Local Street



- Canopy trees utilized in public areas such as parkways, medians, and the public parks to provide shade and natural cooling.
- The use of reclaimed water to irrigate public parks, neighborhood edges, and other common landscape areas.
- Utilization of energy efficient appliances addressing conservation of electricity.
- Recycling of construction materials.

- Reduce water usage by using California-friendly plant materials and recycled water.

SERRANO SUMMIT IDENTITY

1.5

Regional site characteristics and formative elements of the Serrano Summit community include the following criteria:

- Physical characteristics of the site
 - ~ *Native vegetation (eucalyptus trees)*
 - ~ *Landform (hills, Serrano Creek)*
- Local history, heritage and commerce (ranching, agriculture)
- Sociology and culture (Spanish settlements, independent farming, small towns)
- Climate (semi-arid and strong sunlight most of the year)
- Historic and traditional building styles and forms of the region such as Monterey, Spanish Colonial, Santa Barbara and Adobe Ranch

Identifying elements of the thematic building styles are as follows:

- Monterey - rectangular plan form, symmetrical, front balcony, gable roof, stucco walls, board and batten shutters, square posts
- Spanish Colonial - one- and two-story volumes, simple, soft edge, exterior arches, rustic building materials, mostly stucco finished, tile roofing, decorative tile / wrought iron embellishments
- Santa Barbara - boxy, simple massing, one- and two-story stacked elements, recessed entry or covered porch, hip or intersecting gable roof, arches and arcades, balconies, decorative tiling, "S" shaped concrete roof tiles
- Adobe Ranch - simple, often "L" shaped, rectangular two-story massing, gable and shed roof forms, arches and arcades, recessed windows with shutters, painted brick or stone detailing

Other thematic criteria for the Serrano Summit community:

- Must have the ability to be translated to all unifying elements (buildings, walls, entry monumentation)
- Must be capable of modern translation (inclusion of attached garages and other market and code-driven features)
- Be compatible with the surrounding community and context

Below are the general community theme recommendations for Serrano Summit:

- Focus on early California "golden age" styles (up to pre-war era) rather than European transplants (Tuscan, French, English, Andalusian).
- Utilize rustic, natural materials, textures and interpretations rather than formal and refined.
- Colors should primarily be organic and earth toned hues, borrowing from the natural beiges, browns, greens and grays of the site's vegetation.
- Choose styles and elements that "blur" the separation between the indoor and the outdoor.
- Focus on "small town" rather than "big city" characterizations and references.
- It is important that a complete sensory separation begins at the transition between the industrial area to the north and entering the residential community — "you have arrived at a surprisingly different and distinct environment."
- Promote creation of public vista plazas and capture public and private viewscape opportunities, wherever possible.
- Maintain sensitivity of off-site views of Serrano Summit from the surrounding community.

DEVELOPMENT PLAN

1.6

The development plan for Serrano Summit is illustrated on Exhibit 1-5, “Master Land Use Plan.” Land uses planned for Serrano Summit are described in the Land Use Summary, Table 4-1.

GOVERNING DOCUMENTS

1.7

Development of Serrano Summit will be governed by the following:

- The City of Lake Forest General Plan, which establishes policies governing land use, circulation, housing, recreation and resources, public facilities/growth management, and safety and noise.
- The City of Lake Forest Municipal Code (as of the date of approval of this Area Plan document), which governs development within the project area in instances where the Area Plan is silent on development standards and regulations.
- Title 9, Planning and Zoning, of the City of Lake Forest Municipal Code (as of the date of approval of this Area Plan document), except as otherwise specified by the Serrano Summit Area Plan.
- The Serrano Summit Area Plan, which includes a land use plan, open space plan, infrastructure plan, fuel modification plan, landscape concept plan, development regulations, design guidelines, and implementation procedures.
- The approved Serrano Summit Development Agreement, recorded in the Orange County Clerk’s office on October 22, 2008 as document number 2008000486878, which establishes provisions for the development of Serrano Summit related to phasing of land use, timing of infrastructure and other public improvements, and provisions for infrastructure financing.
- Applicable subdivision provisions of the Subdivision Map Act.
- Retaining Wall Design Guidelines as approved by the City Council on June 15, 2010.
- Any and all previous and current Irvine Ranch Water District (IRWD) documents and approvals.
- Covenants, Conditions, and Restrictions (CC&R’s) to be established by the developer of Serrano Summit as a private contract binding property owners with specific restrictions on the use of their property, and establishing a Homeowners Association (HOA) as a means of governance, revenue collection, and management of HOA functions.

AREA PLAN COMPONENTS

1.8

The Serrano Summit Area Plan is organized into the following sections in addition to Section 1, Executive Summary.

Section 2 - Introduction

The Introduction serves to acquaint the reader with:

- Area Plan goals and objectives;
- The project setting;
- A general description of the project proposal;
- The relationship of the Area Plan to the City of Lake Forest General Plan and the City's Municipal Code.

Section 3 - Existing Conditions

The physical setting for Serrano Summit is described in this section outlining the existing physical conditions within and around the project area.

Section 4 - Plan Elements

This section describes the land use planning areas and the acreage, density, and use within each planning area, as well as the system of parks, pedestrian linkages, and open space planned for the community.

Section 5 - Infrastructure & Services

This section provides conceptual plans and information on the community's backbone water, sewer, storm drain systems, and grading concept in addition to a discussion of public facilities provided and public utilities needed to serve the community.

Section 6 - Circulation

This section provides conceptual plans and information on the community's street and pedestrian linkage systems.

Section 7 - Residential Design Guidelines

The Serrano Summit Residential Design Guidelines are intended to direct the site planning and architectural quality of the development, which include:

- Community recreation and common facilities.
- Single family detached, enclave, single family attached, and multi-family homes.
- The use of green building techniques.

Section 8 - Civic Center Design Guidelines

The Civic Center Design Guidelines are intended to direct the site planning, landscape, and architectural quality of development on the 11.9-acre Civic Center parcel.

Section 9 - Landscape Design Guidelines

The Serrano Summit Landscape Design Guidelines are intended to direct the quality of the community landscape, including walls and fences, site furniture, signage, plant palette, fuel modification, and hardscape elements of the development.

Section 10 - Development Regulations

Regulations contained in this section will establish permitted and conditionally permitted uses for the community and the standards regulating the development of land uses within Serrano Summit. The relationship of the Serrano Summit Area Plan development regulations to the City of Lake Forest Municipal Code is also discussed.

Section 11 - Implementation

The Implementation section presents:

- The policies and procedures for the review and approval of specific development proposals, within Serrano Summit by the City of Lake Forest.
- The methods and procedures for interpreting and amending the Area Plan as necessary.
- The policies and procedures for the City of Lake Forest review and approval of specific development proposals within Serrano Summit.
- A summary of project financing and project maintenance responsibilities for new development within Serrano Summit.

Section 12 - General Plan Consistency

This section includes a discussion describing the relationship of the Serrano Summit Area Plan to the applicable policies of the City of Lake Forest General Plan.

INTRODUCTION

Section 2.0

November 2016



AREA PLAN OVERVIEW

2.1

Serrano Summit is an approximately 98.9-acre area located within the jurisdiction of the City of Lake Forest, California. The project area is predominantly vacant land and includes an existing Irvine Ranch Water District (IRWD) plant, water reservoirs, and one office building within the project boundaries. Approximately 56.2 acres within Serrano Summit will be devoted to medium density residential uses, subject to the Public Facilities Overlay. The City of Lake Forest has indicated a desire to build a Civic Center on nine acres within Serrano Summit. The City has requested that an Area Plan be prepared for the project to guide future development and ensure that all potential land uses are consistent with the City of Lake Forest General Plan goals and policies.

The Serrano Summit Area Plan is a comprehensive plan for the development of a master planned community combining a Civic Center site with development of medium density residential neighborhoods designed at a human scale with features that promote walking throughout the community and adjacent open space.

The creation of a sustainably designed, planned community is a fundamental objective for the Serrano Summit Area Plan. Water reclamation and groundwater recharge technology for water reuse is planned to supplement the water needs of the community. A Civic Center, parks, open space areas, and a recreation center are located nearby. Pedestrian and bicycle usage can be used to connect the community and offer an alternative means of travel to the automobile.

The Serrano Summit Area Plan serves as a mechanism and implementation tool to ensure that the development of the new community is accomplished in a cohesive manner and that the community is served by adequate infrastructure, open space, parks, and other recreational amenities. The Area Plan has been approved by Resolution No. ___ and adopted by the City Council. Approval of the Serrano Summit Area Plan includes the approval of a "Master Land Use Plan," contained within this Area Plan. It should be expressly noted that the IRWD specifically retains any and all development rights associated with development within Planning Areas 18 and 19 of the Serrano Summit community and that approval of this Area Plan in no way diminishes or otherwise impacts these rights.



PROJECT SETTING

2.2

The Serrano Summit property encompasses approximately 98.9 acres of predominantly vacant land located south of Commercentre Drive, west of Serrano Creek, north of Serrano Highlands, and northeast of Bake Parkway. The project area is located approximately 3.6 miles from the I-5 Freeway, 2.1 miles from State Route 241 (Toll Road), and one quarter mile from Bake Parkway — the closest arterial street that provides the primary access to the project area. Serrano Summit is centrally located within the Lake Forest city limits.

Currently, the majority of the Serrano Summit property consists of vacant land that was formerly used for agricultural purposes. The land within Serrano Summit is now owned by the Irvine Ranch Water District (IRWD). Portions of the land include an IRWD plant, water tanks, and one office building, which is now abandoned.

The City of Lake Forest General Plan designates much of the project area as “Medium Density Residential.” In addition, a small portion of the “Medium Density Residential” area (approximately 11.9 acres) has a “Public Facilities Overlay” designation. The remainder of the 98.9 acre project site (approximately 8.1 acres), including the land with the IRWD plant and water tanks, is designated as “Public Facility.”

This Area Plan has been prepared for Serrano Summit to ensure that the goals and policies of the General Plan are addressed through implementation of the Serrano Summit Area Plan.



View of the South End of the Property Looking West

AREA PLAN GOALS & OBJECTIVES

2.3



The vision for Serrano Summit is achieved through the implementation of specific goals and objectives established for the Area Plan

Goal - Create a Livable Environment

Objective

Implement a land plan for a livable community incorporating a balance of land uses adequately served by public facilities, infrastructure, utilities, parks, and open space. A livable community should include features such as:

- Facilitation of alternative means of mobility such as biking and walking.
- Opportunities for informal neighborhood interaction.
- Diverse architectural design.
- Connectivity among neighborhoods.
- Diversity and choice of housing types and opportunities for a variety of lifestyles and economic segments of the marketplace.
- Passive and active recreational opportunities located throughout the community.

Goal - Develop a Land Use Plan Responding to Environmental Conditions of the Area

Objective

Address topographic, geologic, hydraulic, and environmental conditions as part of the land use plan.

Goal - Provide for a Range of Housing to Meet the Needs of a Variety of Economic Segments

Objective

Anticipate housing needs and market demand by providing a range of homes targeting the evolving economic profile of the surrounding region.

Goal - Plan for a Circulation System Serving Motorists, Bicyclists, & Pedestrians

Objective

Create a pedestrian-friendly and bicycle-friendly circulation system which encourages walking and biking while providing for the safe and efficient movement of automobiles through the community.

Goal - Create a Strong Community Identity for Serrano Summit

Objective

Implement a set of guiding principles that create a sense of place and promote a sense of belonging by its residents to the community.

Goal - Incorporate Sustainable Features into all Aspects of the Community

Objective

Implement an Area Plan incorporating the fundamentals of sustainability and green design.

Goal - Respond to issues in the EIR by implementing mitigation measures as part of the Area Plan

Objective

Incorporate mitigation measures into the Area Plan document, as applicable and feasible.

Goal - Protect Public Facilities

Objective

Protect existing IRWD facilities and allow for future modifications and improvements by creating separation between these facilities and future residential uses through buffers such as grade separation, landscaping setbacks, etc. that will be needed to serve the City and region.

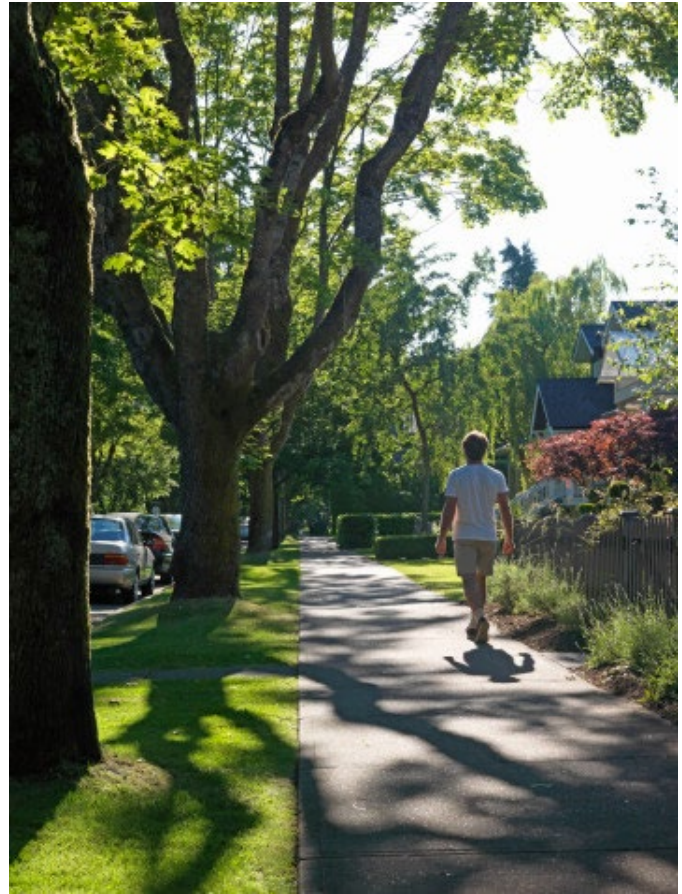

AREA PLAN SUMMARY

2.4



The Serrano Summit Area Plan proposes the development of:

- Residential uses
- A Civic Center
- Sheriff/Police Facilities
- Parks and Recreational Facilities
- Open Space
- Public Facilities

The comprehensive land use plan for Serrano Summit is illustrated in Exhibit 1-3, “Land Use Plan” and described in Table 4-1, “Development Summary by Planning Area.”

Residential Land Use

Medium Density Residential land use comprises approximately 56.2 acres, including 11.9 acres with a Public Facilities Overlay, within Serrano Summit allowing for a variety of residential detached and attached housing types at densities not to exceed 25 dwelling units per acre. Up to 833 single family and attached dwelling units are allocated in Planning Areas 1 through 13, with 11.9 gross acres on Planning Area 13 also allowed for a Civic Center per the Public Facilities Overlay.

Civic Center Land Use

Approximately 11.9 gross acres within Serrano Summit are currently planned for development of a new Civic Center complex for the City of Lake Forest. The complex is anticipated to include a City Hall building, sheriff/police facilities, a Community Center, a public outdoor plaza for community events, and surface and/or structured parking. The approved Development Agreement includes provisions for a Civic Center development timeline, as well as a contingency option for residential development on the 11.9 gross acres. If the City elects to develop the Civic Center off-site or fails to act within the required time limits specified in the City-approved Serrano Summit Development Agreement, then the project master developer may proceed with developing the 11.9 gross acre site with Medium Density Residential units at densities of up to 25 du/ac; provided, however, that the total number of

dwelling units permitted within Serrano Summit shall not exceed 833 dwelling units.

Public Facility Land Use

In addition to the other land uses within the Serrano Summit community, approximately 28.4 acres of the site will be devoted to Public Facility uses required by the Irvine Ranch Water District for their operations including an office building, water reservoirs, treatment plant, and related facilities.

Parks & Amenities

Serrano Summit includes the development of approximately 6.1 acres as parks, including a 1.9 acre site for a private recreation center.

There will be two neighborhood parks and each park will be a minimum of 0.5 acre in size. The neighborhood parks will be improved with open play areas, picnic and barbecue facilities, a volleyball court or ½ court basketball court, and informal gathering areas. In addition to the neighborhood parks, the project will provide for a Passive/Nature Park on-site adjacent to Serrano Creek of 3.2 acres.

The private recreation facility will be constructed on approximately 1.9 acres and will be available for use by project residents and their guests. The facility will include a clubhouse building, restrooms and showers, a swimming pool, tot lot, open play area, and surface parking lot.

Open Space, Greenways & Multi-Use Trail

The Serrano Summit Area Plan establishes connections to the Serrano Creek Trail that runs along an eastern portion of the project area. The Area Plan provides for development of greenways and a multi-use trail linking each planning area within the community to parks, open space, the recreation center, the Civic Center, and the Serrano Creek Trail.



AUTHORITY & REQUIREMENTS OF THE AREA PLAN

2.5

The City of Lake Forest has directed that an Area Plan be prepared for the subject property. The Development Agreement approved by the City Council for the Serrano Summit project sets forth the minimum requirements and review procedures for an Area Plan, which shall include the following plans:

1. Master Land Use Plan;
2. Grading Concept Plan;
3. Site-Wide Grading Cross Section (Section A-B-C);
4. Site-Wide Grading Cross Section (Section D-E);
5. 3-D Grading Model;
6. Circulation Plan;
7. Circulation Plan Cross Sections;
8. Utility Concept Plan;
9. Water Quality Management Plan;
10. Landscape Tree District Plan;
11. Landscape Concept Plan;
12. Public & Private Recreational Facilities Plan;
13. Master Plan of Parks, Trails & Open Space;
14. Wall & Fencing Plan;
15. Fuel Modification Plan;
16. Fuel Modification Notes;
17. Maintenance Responsibilities Plan;
18. Design Plan;
19. Development Phasing Plan; and
20. Public Facilities Phasing & Financing Plan.

No Feature Plan (as defined in Section 9.184.020 of the City of Lake Forest Municipal Code) shall be required by the City of Lake Forest prior to approval of the Serrano Summit Area Plan.

This Area Plan shall be processed per Section 9.184.040(C), "Public Hearings," of the City's Municipal Code. The City Council is the approving authority for all Area Plan applications and amendments per the approved Development Agreement.

DEVELOPMENT APPROVAL COMPONENTS

2.6

The adoption of the Serrano Summit Area Plan is one step in a process leading to the development of the project area. The components of the development approval process for the Serrano Summit project are discussed below.

Area Plan

The Serrano Summit Area Plan, when adopted, will serve as a legal document which implements the General Plan land use designations of “Medium Density Residential” and “Public Facility” within the Serrano Summit boundaries. The designations also include a “Public Facilities Overlay” on the 11.9 gross acre Civic Center site. This Area Plan is designed to serve as a “blueprint” for development within the project area by establishing the distribution of land use and the criteria for development of each land use as set forth herein. The Area Plan establishes the development requirements and guidelines to be applied to each phase of development within the project area. This Area Plan will be adopted by the City of Lake Forest by resolution.

Subdivision Maps/Subdivision Improvement Plans/Design and Construction Plans

Tentative Tract Maps, subdivision improvement plans, and design and construction plans for the development within the Serrano Summit project area will be reviewed and approved by the City of Lake Forest pursuant to the approval of the Serrano Summit Area Plan. Tentative Tract Maps, subdivision improvement plans, and design and construction plans will be prepared pursuant to the applicable provisions of the State of California Subdivision Map Act (Government Code Section 66410 through 66499) and the Lake Forest Municipal Code, and consistent with the applicable provisions contained within the Serrano Summit Area Plan.

An “A” Map will first be prepared defining the residential planning areas, parks, civic center, open space, Irvine Ranch Water District uses and major

infrastructure. Subsequently, individual builders will prepare and submit “B” Maps to the City for approval.

Development Agreement

A Development Agreement has been approved by the City of Lake Forest for the Serrano Summit project. The Development Agreement provides the provisions relating to land use and phasing of development, timing of infrastructure and public facilities, and provisions for infrastructure financing for the Serrano Summit project. The Development Agreement was recorded in the Orange County Clerk’s office on October 22, 2008, as document number 2008000486878.

CEQA COMPLIANCE

2.7

An EIR has been prepared by the City of Lake Forest for the Opportunities Study Area (OSA), including the Serrano Summit project area, in accordance with the California Environmental Quality Act (CEQA) and City requirements to provide a detailed analysis of potential environmental impacts associated with the development within the OSA and Serrano Summit project boundaries. The current EIR prepared for Serrano Summit addresses the potential impacts associated with the project at a “project level.” The EIR includes recommended mitigation measures for the project. All subsequent development approvals will need to incorporate mitigation measures contained in the EIR.

SEVERABILITY

2.8

If any regulation, condition, program, or portion of the Serrano Summit Area Plan, or any future amendment or addition hereto, is held invalid or unenforceable by the decision of a court of competent jurisdiction, then such portions shall be deemed separate, distinct, and independent provisions and the invalidity of such portions or provisions shall not affect the validity and enforceability of the remaining portions and provisions herein.

EXISTING CONDITIONS

Section 3.0

November 2016



SITE & LOCAL HISTORY

3.1

Don Jose Serrano settled this area of the Saddleback Valley, through a 10,688 acre Mexican Land Grant in 1846 by then Governor Pio Pico. Originally named Rancho Cañada de los Alisos (the Valley of the Sycamores), the area later became known as El Toro, named after the bulls that roamed Don Jose Serrano's ranch. Serrano and his family lived on the rancho raising longhorn cattle until a series of droughts, beginning in 1863 and continuing intermittently through 1883, forced the family to divide the ranch and mortgage into several sections. In the early 1900s, Dwight Whiting, a resident of the area, planted 400 acres of fast-growing eucalyptus trees as an answer to the California lumber shortage. Although the trees failed as a source of lumber, in the 1960s, master developer Occidental Petroleum decided to create a master-planned community around the trees and man-made lakes. The eucalyptus provided landscaping for the modern homes and led to the "Forest" in Lake Forest. In 1991, the El Toro area incorporated as the City of Lake Forest. The City currently encompasses an area of just over 16 square miles in size.

The Serrano Summit project area has historically been used for agricultural purposes and, more recently, for use by the IRWD for reservoir storage and treatment plant uses. Currently, the project area is generally undeveloped with the exception of the ongoing IRWD uses, as illustrated on Exhibit 3-1, "Existing Land Uses." The natural vegetation and soil conditions that once occurred on-site have been significantly altered through agricultural use, leaving little or no native vegetation of environmental significance, except at the outer edges of the community.



PROPERTY OWNERSHIPS

3.2

Serrano Summit is comprised of approximately 98.9 gross acres. The applicant owns all of the land within the project boundaries, except for a small parcel (less than 1/8 of an acre) owned by the Metropolitan Water District (MWD) parcel in the southernmost portion of Serrano Summit.

EXISTING LAND USES

EXHIBIT 3-1



SURROUNDING LAND USES

3.3

Land uses adjacent to Serrano Summit include:

- North: Commercentre Drive and existing industrial uses
- South: Serrano Highlands (existing residential community)
- West: Bake Parkway (separated from the site by slopes and undeveloped land)
- East: Serrano Creek and residential

The City of Lake Forest General Plan designates the undeveloped areas surrounding the Serrano Summit project area for the following land uses:

- North: Light Industrial
- South: Low Density Residential (2 to 7 du/net acre) and Low-Medium Density Residential (7 to 15 du/net acre), although the zoning allows for densities in some areas averaging 16.5 du/ac.

- West: Light Industrial and Very Low Density Residential (0 to 2 du/net acre) and Low-Medium Density Residential (7 to 15 du/net acre)
- East: Regional Park/Open Space and Low Density Residential (2 to 7 du/net acre) and Low-Medium Density Residential (7 to 15 du/net acre)

Exhibit 3-2 “Surrounding Land Uses,” illustrates the General Plan land use designations and existing land use characteristics surrounding Serrano Summit.

PHYSICAL SITE FEATURES

3.4

Topography

The land within Serrano Summit rises gently from the south, up from the lowest elevation of approximately 540 feet. The topography gradient increases as the site rises to its highest elevation of approximately 709 feet.







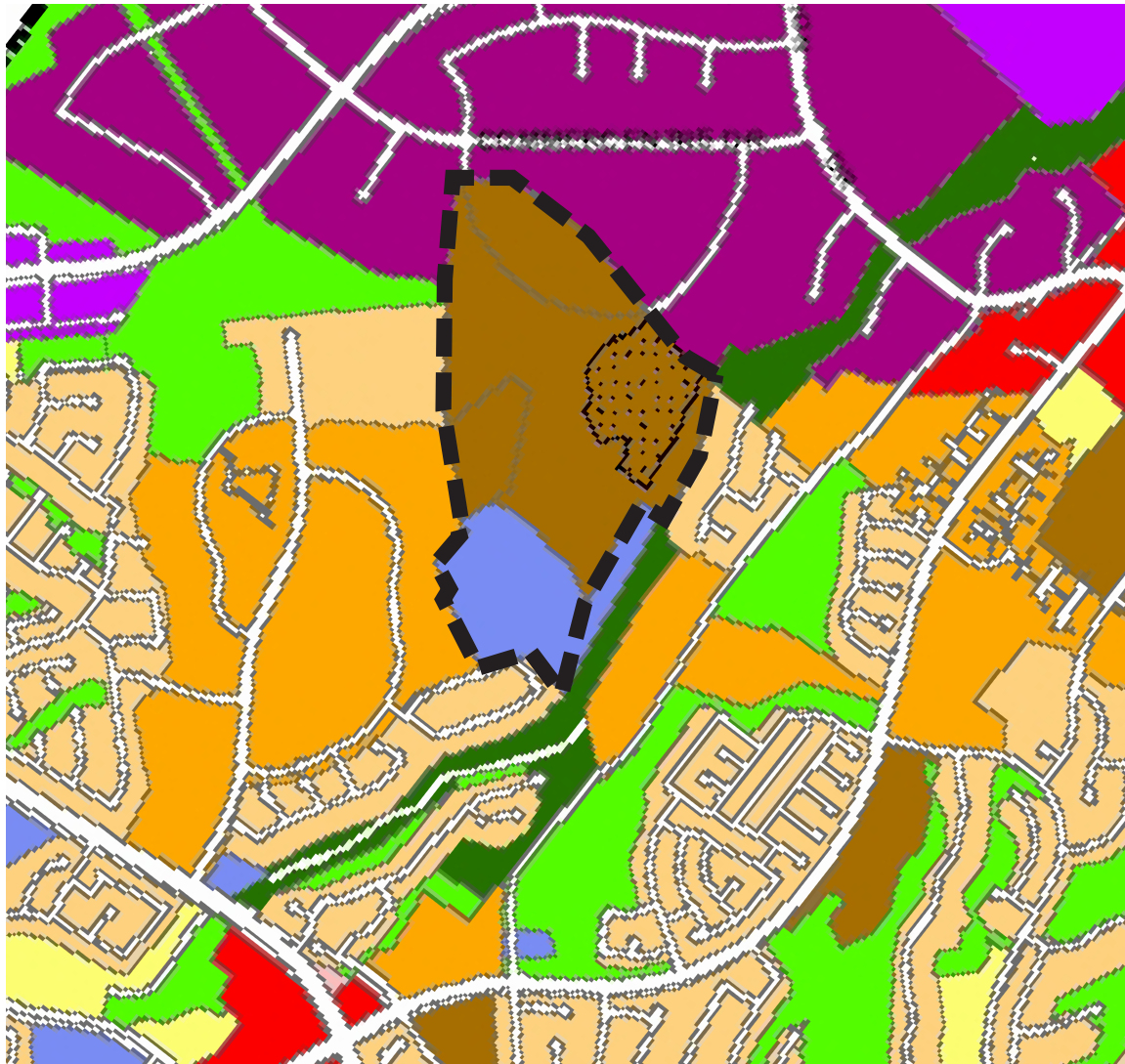





The topographic conditions found within the project area are illustrated on Exhibit 3-3, “Existing Site Topography.”

Site Characteristics

Exhibit 3-4, “Site Opportunities and Constraints,” illustrates select physical site characteristics within the Serrano Summit boundaries.



LEGEND

- | | |
|---|---|
|  Low Density Residential (2-7 DU/Net Acre) |  Public Facility |
|  Low-Medium Density Residential (7-15 DU/Net Acre) |  Community Park / Open Space |
|  Medium Density Residential (15-25 DU/Net Acre) |  Regional Park / Open Space |
|  Commercial |  Open Space |
|  Business Park |  Public Facilities Overlay |
|  Light Industrial |  Project Site Boundary |





SITE OPPORTUNITIES & CONSTRAINTS

EXHIBIT 3-4

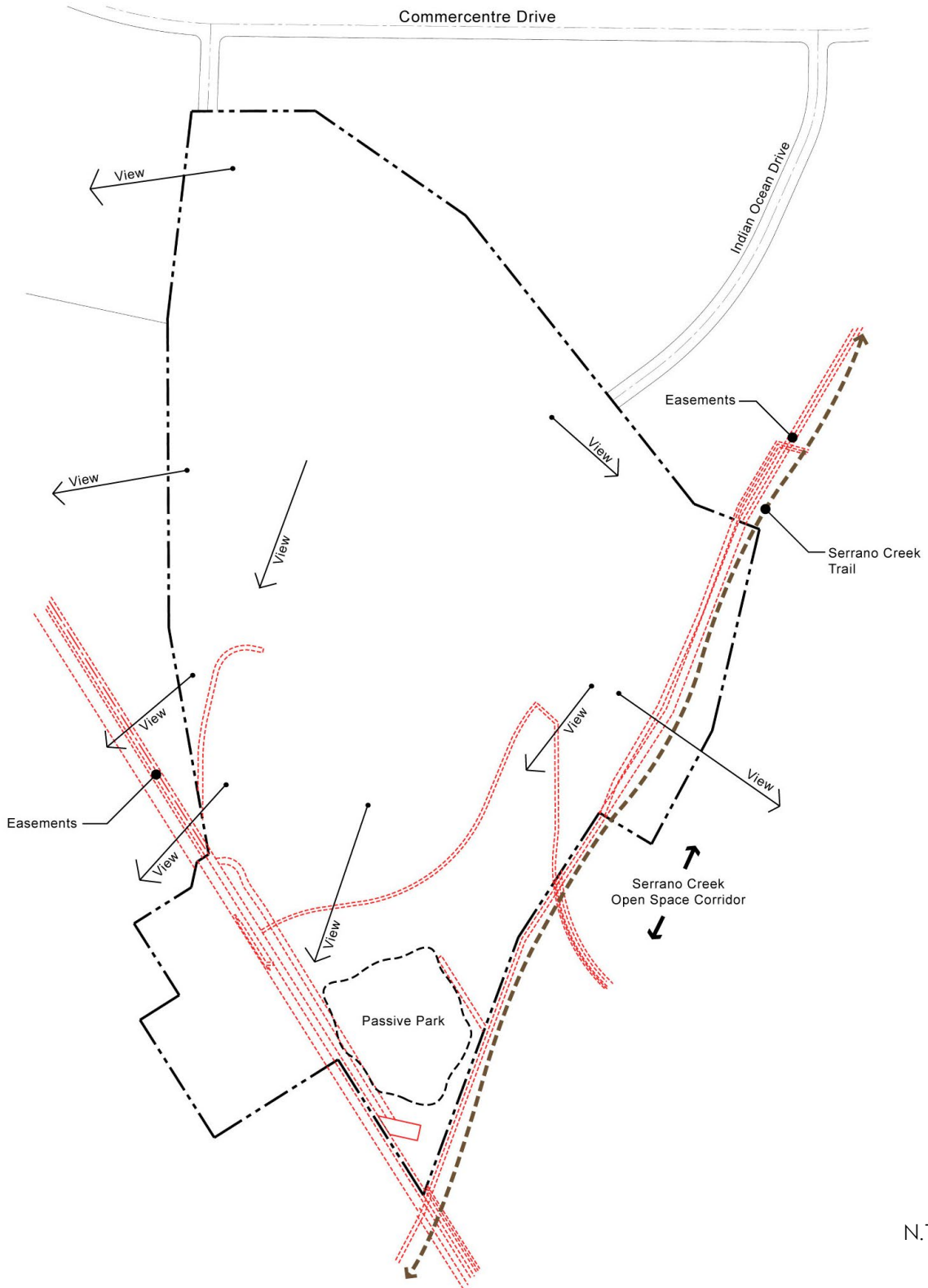

EXISTING CIRCULATION & INFRASTRUCTURE

3.5

Existing Access and Circulation

The I-5 is located approximately 3.6 miles west of Serrano Summit. SR-241 is located approximately 2.1 miles north of the project area. Primary access to Serrano Summit is provided from the I-5 to the project vicinity via Bake Parkway, which is located approximately ¼ mile from the project area. Commercentre Drive is located north of Serrano Summit. Indian Ocean Drive and 'A' Street (Biscayne Bay Drive) provide direct access to the project area.

Commercentre Drive is located north of Serrano Summit, and is currently improved with 64 feet of paved area and 5 foot wide sidewalks. Access from Commercentre Drive to the project area is available from both 'A' Street (Biscayne Bay Drive) and Indian Ocean Drive. Access to the IRWD water facilities is available from Peachwood to the south.

Existing Infrastructure

Water

The Irvine Ranch Water District (IRWD) is the water service provider for the City of Lake Forest and will provide water service for Serrano Summit. A 12-inch domestic water main exists within Indian Ocean Drive, adjacent to the project area. Residential uses shall be connected to the domestic water system. The IRWD's Master Water Facilities Plan of has identified new facilities to serve the project area.

The existing water supply system is adequate to serve the proposed project.

Existing water supply improvements serving/in proximity to the project area are illustrated on Exhibit 3-5, "Existing Infrastructure."

Sewer

The IRWD is the entity providing sewer service to the City of Lake Forest, which will also provide sewer service to the project area. The IRWD's Sub Area Master Plan (SAMP) was completed in October 2010 under the direction of the IRWD and identified

new facilities to serve the project area. Existing sewer facilities in proximity to Serrano Summit are illustrated on Exhibit 3-5, "Existing Infrastructure."

Drainage

There are various existing storm drain facilities on-site ranging in size from 18 inches to 24 inches. Off-site, there is a 36-inch storm drain facility in Commercentre Drive with 30-inch laterals in both Biscayne Bay Drive and Indian Ocean Drive draining north to Commercentre Drive. Drainage flows for Serrano Summit, as with existing surrounding neighborhoods, will end up in Serrano Creek. Detention and water quality basins and facilities will be located upstream to treat the water before it enters Serrano Creek. Existing storm drain facilities serving/in proximity to the project area are illustrated on Exhibit 3-5, "Existing Infrastructure."

Utilities

Electricity

Serrano Summit is located within the service territory of Southern California Edison Company.

Natural Gas

The Southern California Gas Company (SCG) provides natural gas service in the vicinity of the project area.

Communication Systems

AT&T provides telephone service within the Serrano Summit boundaries.

Solid Waste

Waste Management provides solid waste collection and disposal to the City of Lake Forest on a contract basis. Service to the project area can be extended through existing service agreements/contracts.

Cable Television

Cox Communications provides cable television service within Serrano Summit.

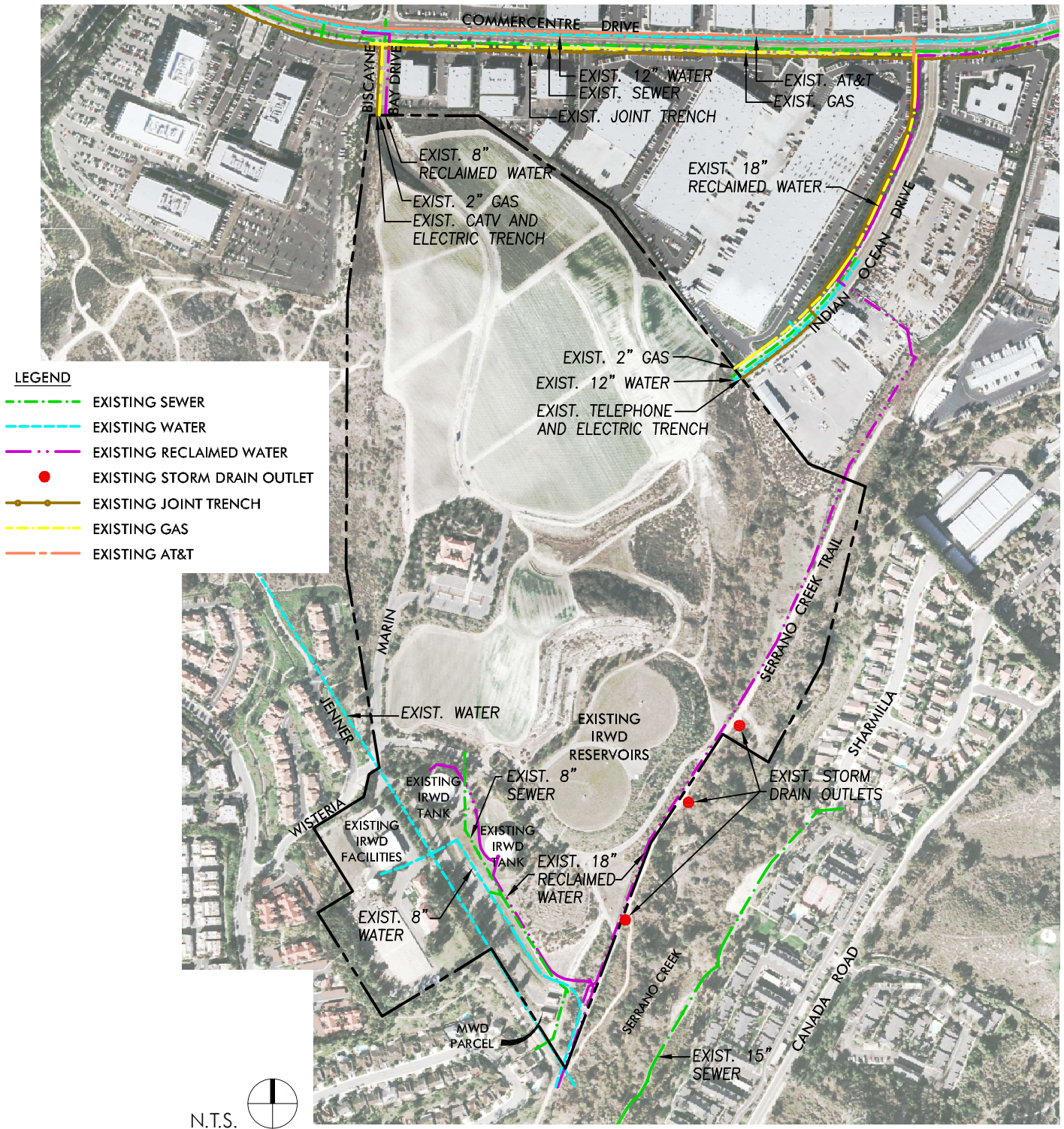

SCHOOLS

3.6

Serrano Summit is located within the boundaries of the Saddleback Valley Unified School District (SVUSD). The SVUSD will serve the school age needs of grades K – 12.

The SVUSD has eight elementary schools in the vicinity of the project area serving grades K – 6. In addition, the SVUSD includes four intermediate schools serving grades 7 – 8. All schools have excess capacity except for an elementary school in Foothill Ranch. The nearest high school to Serrano Summit is El Toro High School, which is located at 25255 Toledo Way in Lake Forest.

In lieu of providing a school site within Serrano Summit, the project master developer will pay the required school fees pursuant to the approved Saddleback Valley Unified School District Mitigation Agreement.



PLAN ELEMENTS

Section 4.0

November 2016



INTRODUCTION

4.1

The Plan Elements in this Chapter of the Serrano Summit Area Plan form the basis of a master land use plan for development of a new community, balancing Medium Density Residential land uses with civic uses, parks, trails, open space, recreational amenities, and Public Facilities.

Among the many proposed community features, Serrano Summit will include a recreation center and two neighborhood parks for the residential development.

The land use plan for Serrano Summit is illustrated in Exhibit 4-1 “Master Land Use Plan.” Table 4-1, “Land Use Summary,” provides a description of the total acreage assigned to each land use category within Serrano Summit.



COMMUNITY THEME

4.2

The thematic inspiration for Serrano Summit draws on the authentic elements of its place and its past: from the adjacency of the Serrano Creek, the rustic character of the open space, and the legacy of the Serrano family who created one of the first cattle ranching operations in this area of the Saddleback Valley.

The Community Theme will be applied throughout the Serrano Summit community including the architecture for the residential development, recreation center, and Civic Center; project-wide landscaping along streets, parkways, parks, and the recreation center; and the designs of community walls and fencing.



Regional Identifiers and Inspiration

The historic and regional characteristics identified below have informed and inspired the thematic identity of Serrano Summit:

- Physical Characteristics of the Site
 - ~ Native vegetation
 - ~ Landforms (hills, creeks)
 - ~ Rustic and natural
- Mexican Land Grants, local history, heritage and commerce (ranching, agriculture)
- Sociology and culture (Spanish settlements, independent farming and ranching, small towns)
- Climate (semi-arid, strong and unobscured sunlight most of the year)
- Historic and traditional building styles and forms of the region (various Spanish historic and revival styles)

Thematic Criteria

- Must have the ability to be translated to all unifying community elements (buildings, walls, entry monumentation)
- Architectural theme must be capable of modern translation (inclusion of attached garages and other market and code driven features)

Recommended Community Theme

The overall guiding theme for the Serrano Summit community is characterized by the following statement:

Authentically inspired by the land, its early history and its Spanish stylistic roots.

Elements supporting the community theme are:

- Architectural styles will focus on early California “golden age” styles (up to pre-war era) rather than European transplants (Tuscan, French, English). These styles may include Monterey, Spanish Colonial, Santa Barbara and Adobe Ranch. Refer to the Architectural Styles



Sheets in the Appendix for information on these styles. Other styles may be approved, provided a style is compatible and consistent with the overall community theme and approved by the Development Services Director.

- Utilize natural materials such as stone, wood and brick, etc.
- Colors should primarily be organic and earth toned hues, borrowing from the natural beiges, browns, greens and grays of the site's vegetation.
- Promote building elements which “blur” the separations between the indoor and the outdoor
- “Small-Town” rather than “Big-City” characterizations and references.
- Create a complete sensory separation and transitional experience between leaving the industrial area and entering the residential community – visitors should feel “they have arrived at a surprisingly different and distinct environment.”
- Promote creation of public vista plazas that capture public and private viewscape opportunities where ever possible
- Maintain sensitivity of off-site views of the project from the surrounding community.



COMMUNITY DESIGN

4.3

Neighborhood Design

When implemented, the Master Land Use Plan for Serrano Summit will result in the development of a new community of walkable neighborhoods with a Civic Center located at the terminus of the central spine road ('B' Street). Sidewalks will connect the residential areas with the Civic Center. The project will be connected by on-street bicycle usage and sidewalks that encourage walking and biking throughout the community.

The plan for Serrano Summit as a "walkable" community is demonstrated in the Master Land Use Plan, and implemented by the following hierarchy of community design:

1. At the Community scale - A single community organized along a spine road ('B' Street) with the recreation center serving as the community focal point at the terminus of 'B' Street. The recreation center location allows all residents to enjoy long views and vistas of the surroundings, even those residents that do not reside on the project perimeter edges.
2. The community will include parkways and streets with sidewalks that will connect the residential areas with the Civic Center and adjacent on-site open space areas.
3. At the Neighborhood scale - Individual neighborhoods designed around shared small neighborhood parks integrating recreation and open space activities into the daily lives of residents.

Pedestrian accessibility is provided throughout Serrano Summit via a system of sidewalks adjacent to the street or separated by landscaped parkways and landscaped paseos. Bicycle access is provided on community streets.

It is encouraged that homes be oriented to front onto public gathering places enabling residents to have their "eyes on the street," promoting a safe hometown feel. Serrano Summit is a community of smaller neighborhoods offering a diversity of architectural types and styles.

Sustainability

The community design of Serrano Summit focuses on the creation of a sustainable community with resource conservation as an important development objective.

- Water conservation is a major feature of Serrano Summit with the incorporation of climate specific land design.
- Reducing automobile trips is encouraged by providing alternative modes of travel including walkways connecting residential areas with the on-site civic uses, parks, open space, and recreational amenities, thereby reducing reliance on the automobile for access to these facilities.
- To further reduce automobile trips, homes in Serrano Summit will be equipped with technologies designed to accommodate home offices potentially reducing the number of residents commuting to work.



Land Use Summary

The following table summarizes the land uses within Serrano Summit by planning area.

TABLE 4-1 DEVELOPMENT SUMMARY BY PLANNING AREA				
RESIDENTIAL PLANNING AREA	EXAMPLE PRODUCT TYPES	GROSS ACRES	UNITS	DENSITY (DU/AC)
1	~ Conventional Single Family Detached Homes ~ Rear Loaded Homes ~ Urban Court ~ Motor Court Homes ~ Green Court Homes ~ Rear Loaded Duplex Homes ~ Front Loaded Duplex Homes ~ Attached Enclave Homes ~ Townhomes ~ Rear Loaded Stacked Flat Condos ~ Apartments	6.9	608	Not to exceed 25.0*
2		1.0		
3		2.0		
4		1.4		
5		7.1		
6		6.6		
7		1.8		
8		1.6		
9		1.5		
10		2.1		
11		3.5		
12		8.8		
PA 1 to PA 12 SUBTOTAL		44.3	608	Not to exceed 25.0*
13	SFA/Apartments**/**	11.9	225	18.9
SUBTOTAL RESIDENTIAL		56.2	833	14.8
14	Recreation Center	1.9	-	-
15	Neighborhood Park	0.5	-	-
16	Neighborhood Park	0.5	-	-
17	Passive/Nature Park****	3.2	-	-
18	Public Facility/Open Space (IRWD)	20.3	-	-
19	Public Facility (IRWD)	8.1	-	-
-	Roadway Rights-of-way	8.2	-	-
TOTAL		98.9	833	8.4

Table 4-1 Notes:

* The maximum permitted residential density per planning area shall not exceed 25 dwelling units per acre.

** The Public Facilities Overlay allows for the development of a Civic Center in Planning Area 13.





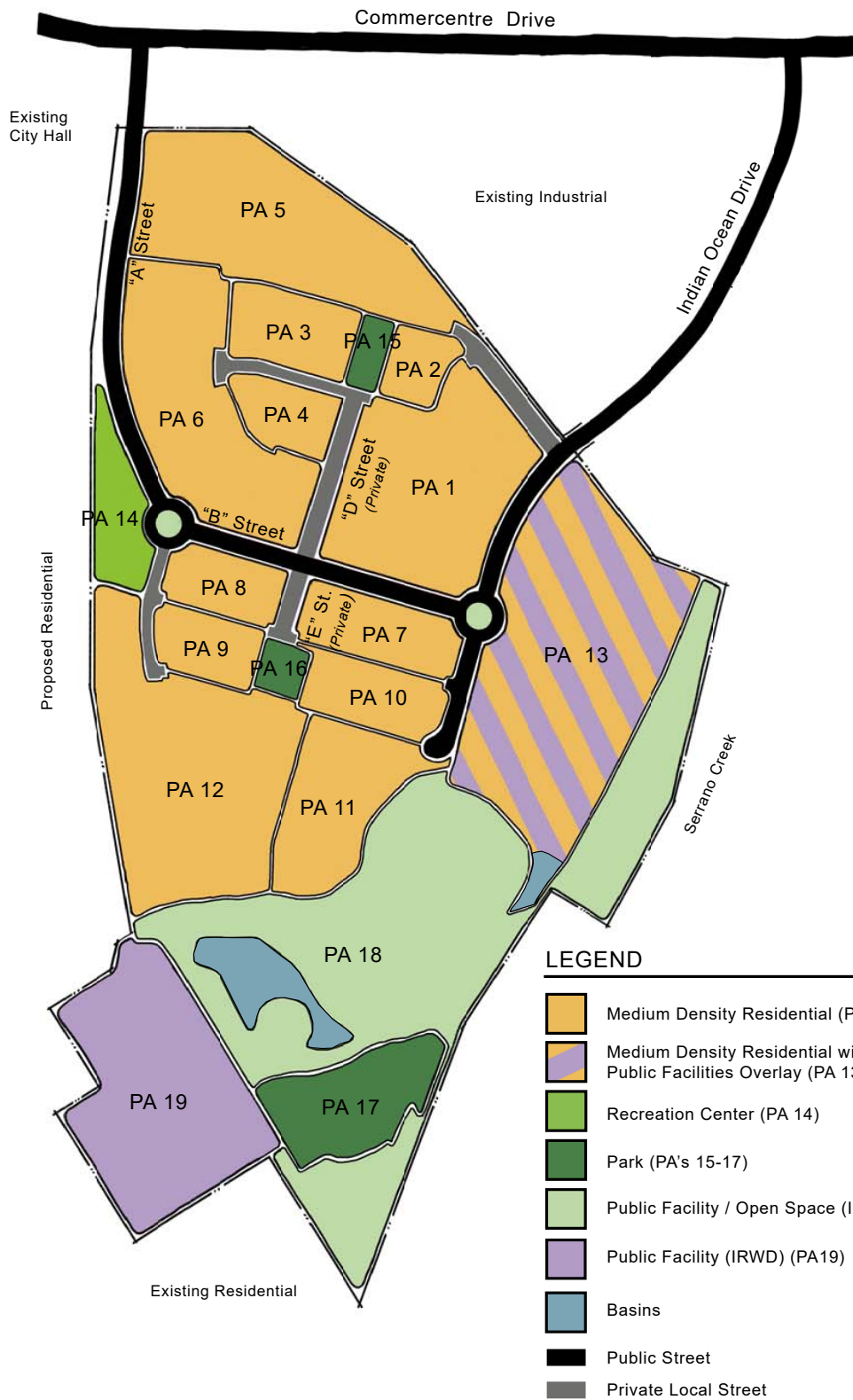



***Per the Development Agreement, if a Civic Center is developed on this site, it will be on a minimum of 8.13 usable net acres.

****Per the Development Agreement, a neighborhood park will be provided on a minimum of 2.95 usable net acres.



N.T.S. 

LEGEND

	Medium Density Residential (PA's 1-12)
	Medium Density Residential with Public Facilities Overlay (PA 13)
	Recreation Center (PA 14)
	Park (PA's 15-17)
	Public Facility / Open Space (IRWD) (PA 18)
	Public Facility (IRWD) (PA 19)
	Basins
	Public Street
	Private Local Street

PLAN ELEMENTS

4.4

Residential

Residential planning areas comprise approximately 56.2 acres of Serrano Summit, including 11.9 gross acres of Public Facilities Overlay (Planning Area 13). A maximum of 833 residential dwelling units in a variety of density ranges and housing types are planned in Planning Areas 1 through 13. A description of the potential residential housing types planned for Serrano Summit is listed below. If the City elects to build the planned Civic Center on the Public Facilities Overlay, then the 11.9 gross acres will contain the new Civic Center site (Planning Area 13). Alternatively, the project may build out with up to 833 dwelling units.

A variety of residential housing types are permitted within Serrano Summit, not all of which are represented above in Table 4-1. Table 4-1 is provided as one example of how Serrano Summit may be developed in terms of product mix. Ultimately, the builders of Serrano Summit will determine the appropriate product mix, as dictated by the marketplace and within the constraints of this Area Plan.

The housing types described below are intended to address a variety of economic segments of the market. These housing types are permitted in every planning area within Serrano Summit.

Single Family Detached Residential

Conventional Single Family Detached Homes

Conventional residential homes on a variety of lot sizes are allowed. Local residential streets provide access to these home types and alternative garage configurations are encouraged with an “architecture forward” design that extends living areas and porches forward of the face of the garage.

Rear Loaded Homes

This traditional single family home concept places garages at the rear of the lot accessed from a private drive or lane. Front doors and porches face neighborhood streets or open space areas. A

pedestrian oriented streetscene is promoted with this residential type because garages are not visible from the street and driveway curb cuts are not present along the street.

Single Family Detached Enclave Residential

Detached homes in enclaves of typically eight or less homes designed around a common private drive minimize the view of garages from the street and consolidate driveway curb cuts along neighborhood streets to promote pedestrian connectivity. The front doors of these enclave homes may be taken from the street, the common private drive, or a paseo or open space area, resulting in a variety of plotting conditions.

Urban Court

A smart-growth alternative to traditional, suburban style single-family subdivisions, urban court homes have smaller lot areas with compact building footprints and reduced yard setbacks, street frontages, passageways between buildings, and open space. Urban Court single family homes provide more space-efficient and economically attractive alternative for sites planned for apartments or condominium uses.

Motor Courts

Detached single family homes are clustered around “motor courts” which provide access to front-loaded garages. In most cases, parking can be accessed from the motor court streets. Since many homes’ front doors will face onto the interior parking court, special care must be taken to create street-friendly elevations, with front doors and windows facing the street on the homes closest to the street.

Green Courts

Green courts are detached single family homes that face onto two sides of a shared green. The shared greens provide a controlled environment for younger children and a park-like atmosphere in which to play without crossing any streets, as the court-facing homes allow easy supervision by parents or

community members. Green courts also serve as a setting for informal interaction and gatherings. At least one side of the green is adjacent to a street, making front entrances visible from the street and providing on-street guest parking opportunities. Because the homes face a common green space, garages must be accessed from rear alleys or common drives.

Single Family Attached Residential

Rear Loaded Duplex Homes

Paired homes are commonly referred to as duplexes. These single family attached homes encourage the utilization of rear loaded garage configurations and “architecture forward” floor plan designs to minimize or eliminate garages visible from neighborhood streets.

Front Loaded Duplex Homes

Front loaded duplex homes take both front door and garage access from the neighborhood street. Though attached, these homes often have massing that suggests the character of a detached home, making these duplexes compatible with lower-density neighborhoods.

Attached Enclave Homes

Attached enclave homes consist of attached units that remove garages from the street and consolidate curb cuts with access provided from private drives. Front doors may either face an open space courtyard created by the form of the building, with pedestrian walkways separated from the street, or directly onto the neighborhood street itself.

Townhomes

This traditional attached home concept places garages at the rear of the building accessed from a private drive or alley. Front doors and porches face neighborhood streets and open space areas. Generally, no garages face the street and no driveway curb cuts interrupt the pedestrian connectivity along the street.

Rear Loaded Stacked Flat Condos

In stacked condominiums products, garages are oriented onto a private motorcourt served by a drive, with front doors opening onto linear paseos, courtyards or neighborhood streets.

Multi-Family Attached Residential

Apartments

Apartments include all types of rental products and may vary in height from two to three stories. Apartments may include garages and/or carports.

Civic Center (Public Facilities Overlay; Planning Area 13)

Approximately a 11.9 gross acre site within Serrano Summit is Medium Density Residential, but is also subject to a Public Facilities Overlay. The site is currently planned for a Civic Center. The Civic Center will be designed to serve as the governmental offices for the City of Lake Forest. The Civic Center is anticipated to contain a City Hall, a Community Center, sheriff/police facilities, a public outdoor plaza, and surface and structured parking.

Public Facility/Open Space (Planning Area 18)

Approximately 20.3 acres within Serrano Summit will be identified as Public Facility/Open Space. The open space will include a multi-purpose trail. The trail will provide connections between the Serrano Summit community and the regional trail system (i.e., the Serrano Creek Trail) and the 3.2 acre passive/nature park (Planning Area 17). The trail will provide pedestrian and bike connectivity from the northeastern portion of the City of Lake Forest along Serrano Creek and adjacent to Serrano Summit.

Public Facility (Planning Area 19)

Approximately 8.1 acres on-site are now used for or planned for development of Public Facility uses by IRWD in Planning Area 19. This area will continue to be used for the IRWD water facilities.

Parks & Trails

Approximately 6.1 acres of Serrano Summit are reserved as parks, trails, and a recreation center. Approximately 4.2 acres of the 98.9 acre project area will be developed as parkland to provide for the active and passive recreational needs of the community in addition to a 1.9 acre recreation center site. The neighborhood parks will be located within a short walking distance of the surrounding residences.

There will be two on-site neighborhood parks. There will be one neighborhood park in Planning Area 15 and another in Planning Area 16. Each neighborhood park shall be a minimum of 0.5 acre in size. Each of the 0.5 acre neighborhood parks will be improved with one or more of the following amenities:

- Seating areas
- Sport court
- Tables, benches, trash cans, drinking fountains, and barbecues
- Shade structure for group recreation purposes
- Play area/tot lot
- Informal gathering areas

In addition to the neighborhood parks, the project will include a Passive/Nature Park on-site adjacent to Serrano Creek that will be approximately 3.2 acres in size. The park is described in more detail in Section 9.11 and on Exhibit 9-17. This park will contain, at a minimum, the following amenities:

- Tables, benches, trash cans, drinking fountain, and barbecues
- One shade structure for group recreation purposes
- Hitching posts
- Watering trough

As part of the neighborhood parks system, Serrano Summit includes development of an approximately 1.9 acre private recreation center. This recreation facility will be available for use by Serrano Summit residents and their guests. The facility will include a clubhouse building, restrooms and showers, a swimming pool, tot lot, open play area, and surface parking lot. The recreation center has been specifically sited to offer views and vistas of the surrounding areas.

The parks, trails, open space, and Public Facilities planned for Serrano Summit are illustrated on Exhibit 4-2, "Master Plan of Parks, Trails, and Open Space."



MASTER PLAN OF PARKS, TRAILS & OPEN SPACE

EXHIBIT 4-2



INFRASTRUCTURE - PUBLIC FACILITIES & SERVICES

Section 5.0

November 2016



DOMESTIC WATER

5.1

Domestic water will be supplied to Serrano Summit by the Irvine Ranch Water District (IRWD). IRWD presently provides domestic water service to an approximate 179-square mile area in central Southern California. Serrano Summit's average daily water demand is approximately 200,000 gallons per day, or 224 acre feet per year. Potable water to serve the project site will be supplied per the Sub Area Master Plan (SAMP) to be prepared under the supervision of IRWD and the property owner.

At this time, the project has identified regional facilities for two points of connection possibilities to provide adequate domestic and fire water services to the site. The first point of connection is at the boundary line adjacent to Indian Ocean Drive, where an existing 12" water line has been stubbed out to this site. The second point of connection will be within Commercentre Drive at the intersection of Biscayne Bay Drive, where there exists another 12" water line. In order to reach the project site, approximately 300 linear feet of mainline pipe will be needed to be constructed off-site.

Existing regional facilities capable of providing service to Serrano Summit are listed below:

- An existing 12" domestic water line in Indian Ocean Drive; and
- An existing 12" domestic water line in Biscayne Bay Drive.

Facilities needed to provide flow and pressure in conformance with IRWD and fire department standards include mainline pipe sizes ranging from 8" to 12" and looped configurations to ensure pressure efficiencies.

Water System Development Standards

- All water lines shall be designed per IRWD requirements, installed underground in accordance with the requirements and specifications of the Orange County Health Department, and inspected per IRWD standards.
- The location of facilities shall conform to IRWD and City of Lake Forest standards.

- Water conservation measures will be incorporated into the development to include water saving devices and systems and including the use of reclaimed water for irrigation where possible.
- Any design of off-site facilities shall be coordinated with the affected property owners and IRWD.
- The design of all water facilities for the purposes of fire protection shall be subject to the review and approval of the Orange County Fire Authority.

RECLAIMED WATER

5.2

Reclaimed water will be supplied to Serrano Summit by IRWD. IRWD presently provides reclaimed water service to approximately 7,000 acres in the central Southern California area. Serrano Summit's average year reclaimed water demand is approximately 400 ac-ft. Reclaimed water, if available, will be used to irrigate landscaping in parks, streets, parkways, common areas and open space areas. Existing regional facilities capable of providing service to Serrano Summit include an existing reclaimed water mainline adjacent to the project site within Biscayne Bay Drive, and existing reclaimed water mainline at the southerly corner of the project site. All proposed IRWD reclaimed water facilities will be designed in conformance with IRWD standards. Standards typically would include a 4" or 6" looped mainline throughout the community. All facilities will be designed in accordance with the SAMP for this project, to be created under the supervision of IRWD and the property owner.

Reclaimed Water System Development Standards

- All reclaimed water lines shall be designed per IRWD requirements, installed underground in accordance with the requirements and specifications of the Orange County Health Department, and inspected per IRWD standards.
- The location of facilities shall conform to IRWD and City of Lake Forest standards.
- Reclaimed water facilities shall be constructed per IRWD standards for supplying reclaimed water to eligible irrigated lands.
- Water conservation measures will be incorporated into all development within Serrano Summit to include water saving devices and systems including the use of reclaimed water for irrigation where possible.
- Any design of off-site facilities shall be coordinated with the affected property owners and IRWD.

SEWER

5.3

Sewer service to Serrano Summit will be provided by IRWD. IRWD presently provides sewer service to approximately 179-square miles in central Southern California. Serrano Summit's average day wastewater generation is approximately 150,000 gallons. Wastewater generation, system hydraulics and facility planning will be based on the Sub Area Master Plan (SAMP) for the project, to be prepared under the supervision of IRWD and the property owner. According to IRWD standards, Serrano Summit will install transmission sewer mains ranging in size from 8 inches to 12 inches. Facilities needed to provide sewer service in conformance with IRWD standards include all facilities as referenced in the SAMP, as prepared by the IRWD.

Sewer System Development Standards

- All sewer lines shall be designed per IRWD requirements, installed in accordance with the requirements and specifications of the Orange County Health Department, and inspected per IRWD standards.
- The location of facilities shall conform to IRWD and City of Lake Forest standards.
- Any design of off-site facilities shall be coordinated with the affected property owners and IRWD.

DRAINAGE

5.4

The Serrano Summit project proposes a comprehensive system intended to collect, convey and deliver storm flows in accordance with both City of Lake Forest and County of Orange requirements. The primary goal of the storm water management system is to prevent flooding and protect property by providing safe, effective site drainage. Serrano Summit contains approximately four existing drainage areas ranging in size from 2 acres to 59 acres. The existing regional storm drain facility capable of serving Serrano Summit is the Serrano Creek to the southeast of the site. Hydrology, hydraulics and facility planning are based on a preliminary hydrology report dated June 2008 by Fuscoe Engineering. The storm water management system generally consist of the following conveyance facilities: Terrace drains, down drains, outlet structures, parkway culverts, earthen swales, area drainage systems, underground piping, catch basins, manholes, junction structures, and energy dissipaters. The Serrano Summit storm drain system also includes a detention area in the park just north of private 'D' Street (in Planning Area 15).

Drainage Development Standards

- Drainage and flood control facilities and improvements shall be provided in accordance with the City of Lake Forest and the County of Orange requirements.
- Storm drain facilities shall ensure the acceptance and disposal of 100-year storm runoff without damage to streets or adjacent property.
- All areas within Serrano Summit will be required to prepare a Storm Water Pollutant Prevention Plan (SWPPP) in accordance with the requirements of the National Pollutant Discharge Elimination System (NPDES) standards.

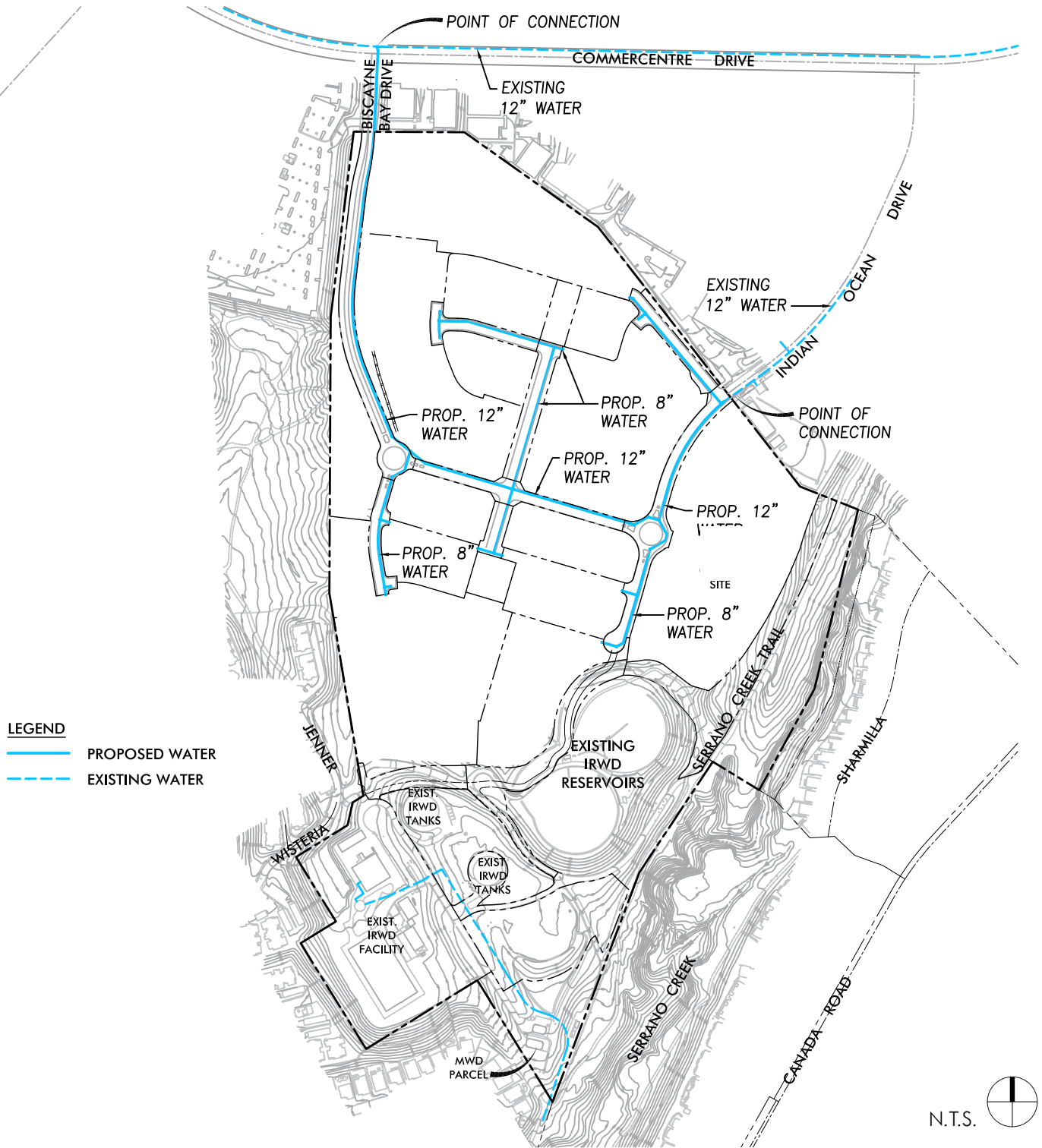

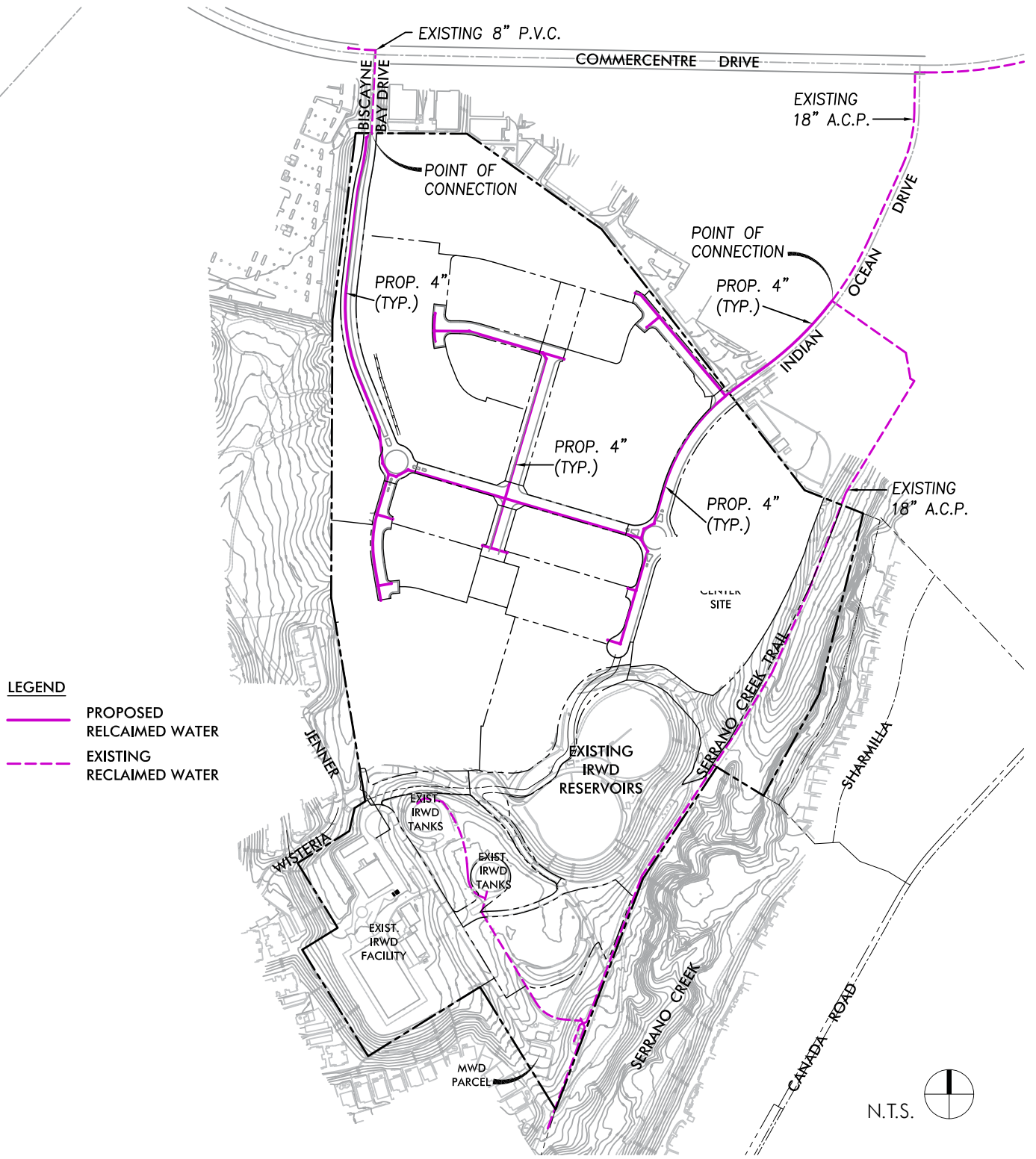

SERRANO SUMMIT AREA PLAN

LEGEND

- - - PROPOSED SEWER
- EXISTING SEWER

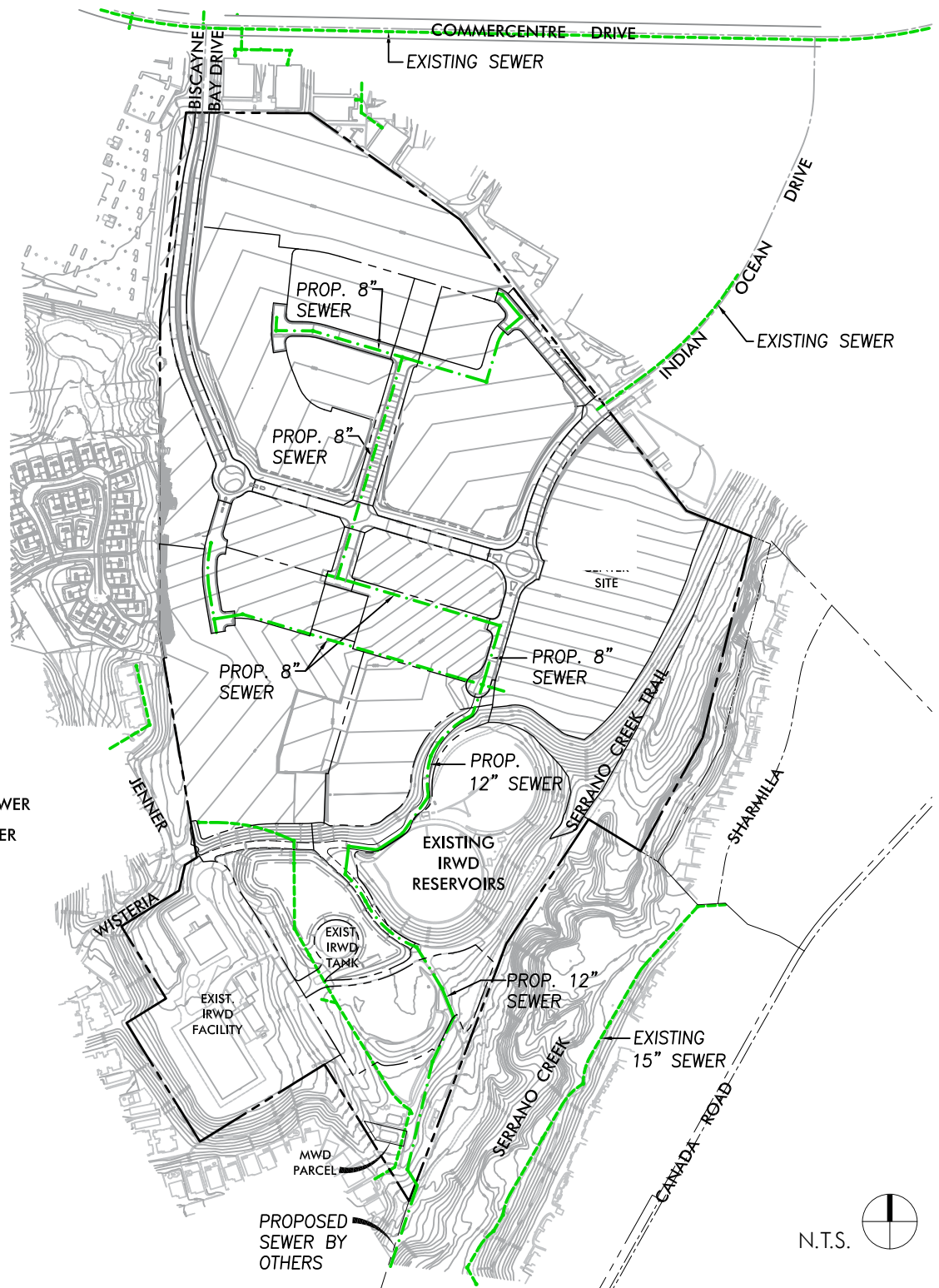

WATER QUALITY

5.5

A Water Quality Management Plan (WQMP) will be prepared for the grading and drainage operations for Serrano Summit, designed to filter and treat surface runoff in a manner to comply with requirements of the City of Lake Forest and the Regional Water Quality Control Board. To mitigate potential impacts, this WQMP relies on a variety of facilities, each specifically located within the system to provide incremental removal of urban pollutants. The applicant will comply with requirements of the National Pollutant Discharge Management Elimination System (NPDES) permit. The applicant will provide Best Management Practices (BMPs) to control discharges of pollutants into receiving waters. Plans for such improvements shall be approved by the City of Lake Forest. The main feature of this WQMP is a 2.1 acre detention/water quality basin located in the area adjacent to the two above ground tanks in the southerly portion of the site.



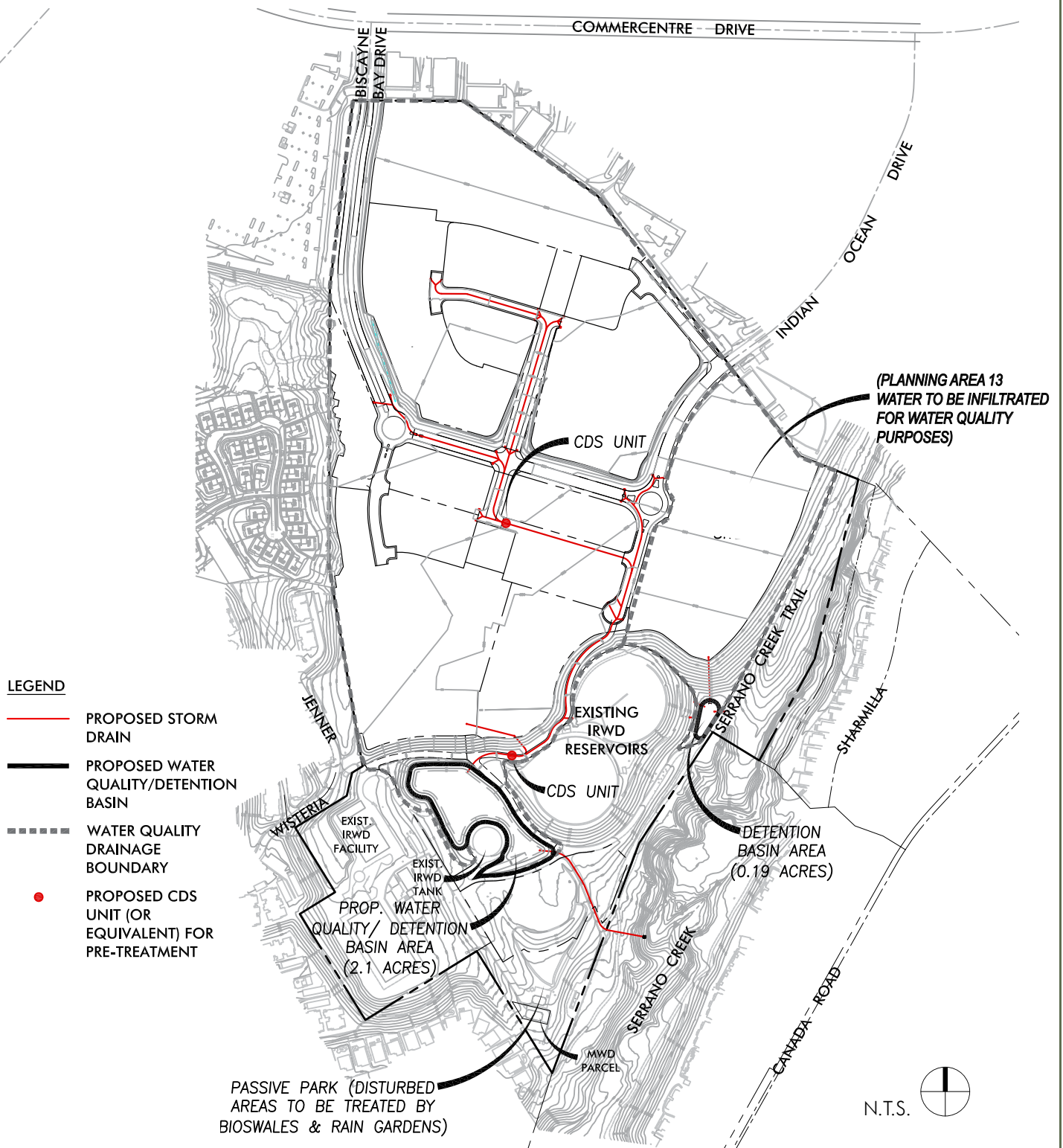

SERRANO SUMMIT AREA PLAN

GRADING

5.6

Grading for the Serrano Summit project reflects a conceptual grading approach consistent with requirements of the City of Lake Forest and the County of Orange and includes mass graded pads at a minimum of 1% slope. More detailed grading plans will be required as part of the approval of any Tentative and Final subdivision maps. In general, considerations while preparing the concept grading plan include preservation of existing edge conditions, where possible, and to minimize any export or import. Additionally, terracing of the site was implemented to preserve and enhance views and develop flat pads such that conventional product types could be efficiently land planned.

The Conceptual Grading Plan shall be used as a guide for the final grading design.

Grading work shall be balanced on-site, and within adjacent development phases, if possible. If a development proposal does not include an entire Planning Area, then prior to the approval of the proposed development an overall conceptual grading plan for the entire planning area shall be submitted for Planning Department approval. The conceptual grading plan for each planning area shall be used as a guideline for the preparation and evaluation of subsequent detailed grading plans for individual stages of development within that Planning Area. The conceptual grading plans for any Planning Area shall include preliminary pad and roadway elevations. Grading plans submitted for review and approval should include a plan for the mass grading and movement of large quantities of dirt from one area of the development to another for balance purposes. Rough grading plans should include information detailing movement of dirt to rough grade elevations that approximates the final finished grades and a precise grading plans should include information detailing movement of dirt to a finished grade tolerance required for the construction of structures and road improvements.

The existing elevations at the project site range from approximately elevation 540 at the south corner of the site to approximately elevation 705 near the northwest corner of the site which is close to the Biscayne Bay Drive entrance. To the south beyond the proposed residential development, there are four IRWD tanks on-site — two underground tanks

and two above ground tanks. These four tanks are located at the southern portion of the site and are at approximately elevations 628 for the top of the buried tanks, 605 and 595 for the above ground tanks. The terrain is irregular with respect to grading; however, the site tends to drain from the north to the south at a gross level, at a more detailed level there are berms, knobs, basins, slopes, terracing, and many storm drain features to collect water and remove off-site.

The midsection of the site is relatively flat having slopes in the range of 1.5% to 2.0%, the west edge has a berm type effect being much higher than the middle/gut portion of the site, as the east edge has down slopes with terracing and drainage channels that collect water and take it off-site with an existing storm drain outlet. As the site progresses southward, there are slopes and additional terracing to get to the top of the underground tanks, and to get to the pad levels of the above ground tanks. At that point, there are access roadways for IRWD facility maintenance, and a host of underground infrastructure to feed these facilities.

Given the irregularity of the existing grade, the water quality issues with regard to Water Quality/ Detention basin location options, and the land use plan, the site will be transformed into mass graded pads with two main terraces, while keeping the southerly IRWD facility area largely intact. The upper tier occurs just north of 'A' Street and 'B' Street and ranges in height from approximately 24' to 28' above the lower tier just south of 'A' Street and 'B' Street. The existing berm on the west edge has been knocked down for view purposes and the sump on the east edge has been filled in in order to form the proposed new Civic Center pad. The lower tier extends from 'B' Street to the existing terrace just north of the existing underground tanks. This terrace assists with views while maintaining original land forms and aiding with a proposed balance cut and fill site. An area between the two above ground tanks will be graded out for the water quality/detention basin and the dirt from that excavation will be used to the north for required fill areas. Regarding the cut, fill, and balance concepts, the cut areas generally are as follows:

- The northerly edge from Indian Ocean Drive west to the westerly property line - average 15';

- The west edge of the property southerly to the IRWD facilities area (with the exception of filling one ravine) – average 20’;
- An area of cut that starts south of ‘B’ Street and encompasses the westerly midsection of that mass graded pad area – average 25’;
- The fill areas of the site are generally in the middle of the upper tier – average 13’;
- The entire east side where the Civic Center site is proposed - average 40’;
- There is also a sizeable fill area just north of the above ground tanks – average 16’.

In addition to those cut and fill areas, there will be remedial grading requirements per the soils engineer, which will account for some additional cut and fill. Preliminary calculations for the earthwork include accommodations for bulking of some of the cut material, shrinkage of some of the cut material, and subsidence of some of the fill material. All this considered, it appears that the graded portions of Serrano Summit are close to a balanced site.

Exhibit 5-7 shows two site-wide grading cross sections (Section A-B-C and Section D-E) through Serrano Summit. In addition, a three-dimensional mesh model depicting the actual grading of the Serrano Summit site is shown in Exhibit 5-8, 3D Grading Model.

Grading Plan Development Standards

- After approval of a tentative tract map, the developer may submit plans for rough grading.
- After approval of a tentative tract map, the developer may submit plans for rough grading.
- A grading permit shall be obtained from the City of Lake Forest, as required by the City of Lake Forest, prior to grading.
- All public collector and local streets shall have a minimum gradient of 1%.
- All private streets and drives shall have a minimum gradient of 0.5%.
- Prior to initial grading activities, a detailed geotechnical study shall be prepared to analyze on-site soil conditions and slope stability.
- Slopes exceeding ten feet (10’) in vertical height are allowed provided they are recommended to be safe in a Slope Stability Report prepared by a soils engineer or an engineering geologist and approved by the City of Lake Forest’s City Engineer. Orange County Grading Code

will be observed with regard to slope setback requirements.

- The applicant shall be responsible for maintenance and upkeep of all planting and irrigation systems until those operations are the responsibilities of other parties.
- Potential brow ditches, terrace drains, or other minor swales, as determined necessary by the City of Lake Forest at future stages of project review, shall be in conformance with the Orange County standards.
- In order to achieve an earthwork balance within any development phase, grading may encroach into an area of future development. Encroachment into these areas may involve the borrowing or temporary stockpiling of dirt to balance areas in the order of the project phasing. If such is the case, grading plans shall be prepared for this purpose and grading will be performed in a manner consistent with the Orange County and City of Lake Forest requirements. The overall Conceptual Grading Plan for the project will be used as a guide for the overall project as well as any conceptual grading plans for an individual planning area. Any off-site grading shall adhere to all Orange County and City of Lake Forest requirements and these Grading Plan development standards. Any grading involving another parcel must have the permission of all applicable property owners and appropriate easement documents.
- Graded land that is undeveloped shall be maintained weed-free, treated with soil binder, or other approved methods of soil stabilization, to prevent dust and dirt erosion. Planting with interim landscaping shall comply with NPDES Best Management Practices for wind and water erosion control.

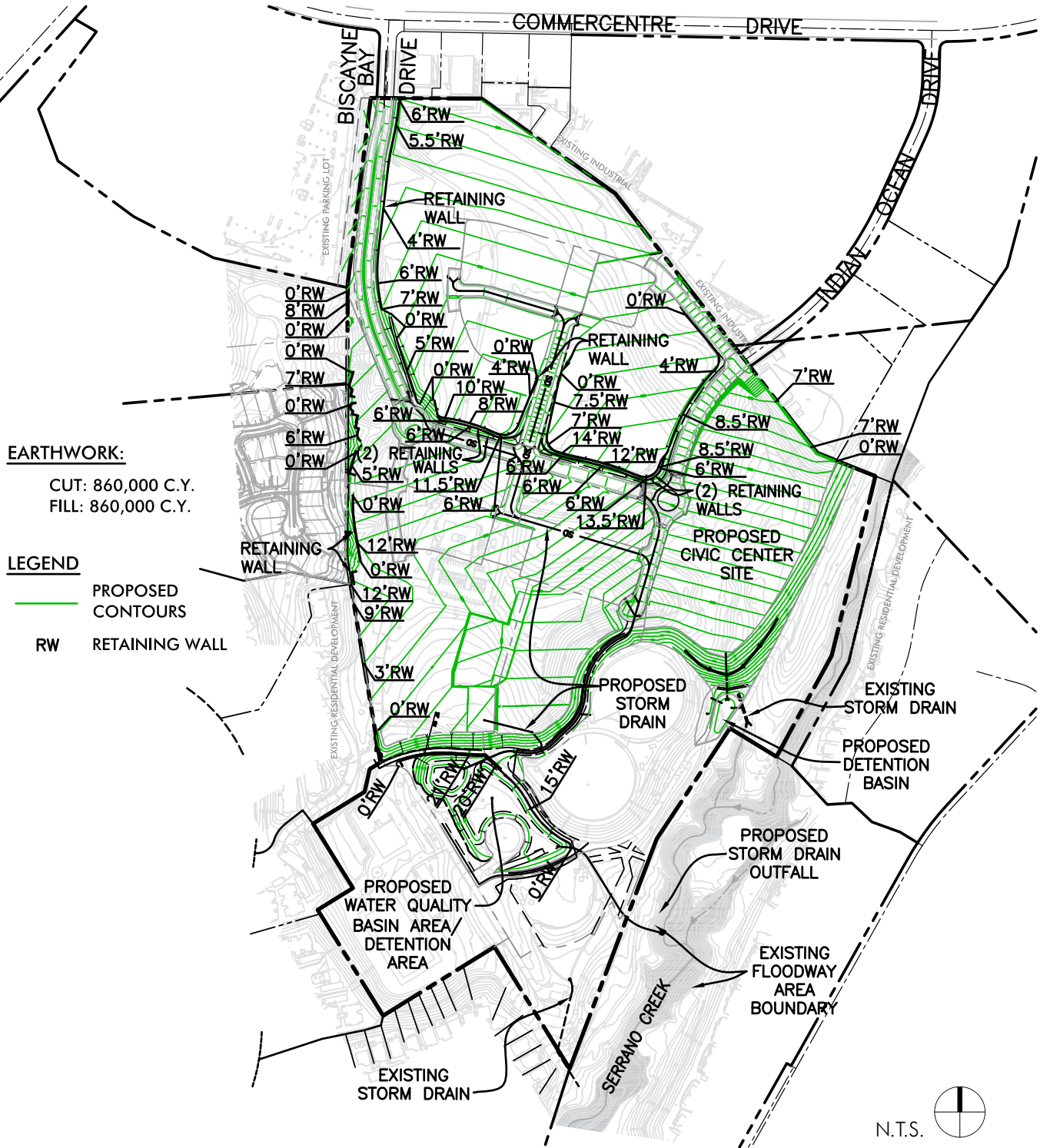

SITE-WIDE GRADING CROSS SECTIONS

EXHIBIT 5-7

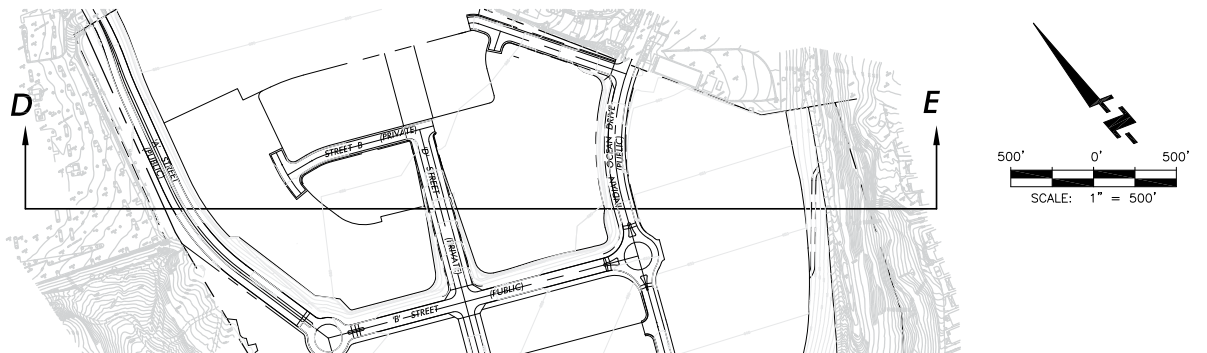
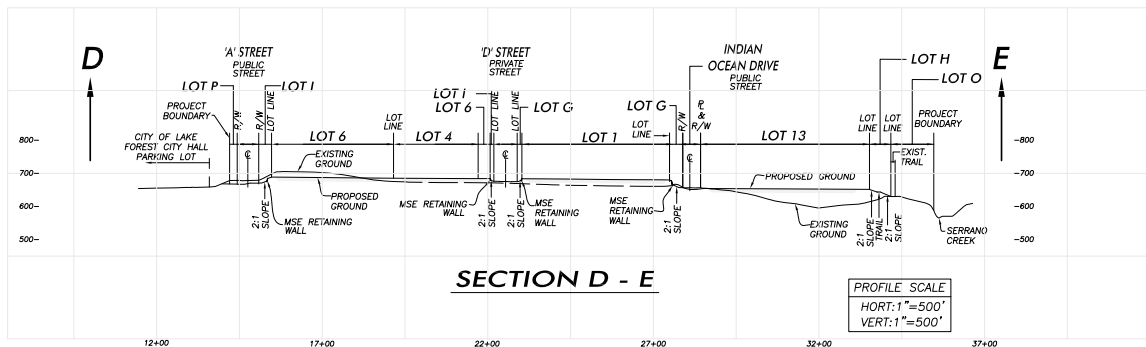
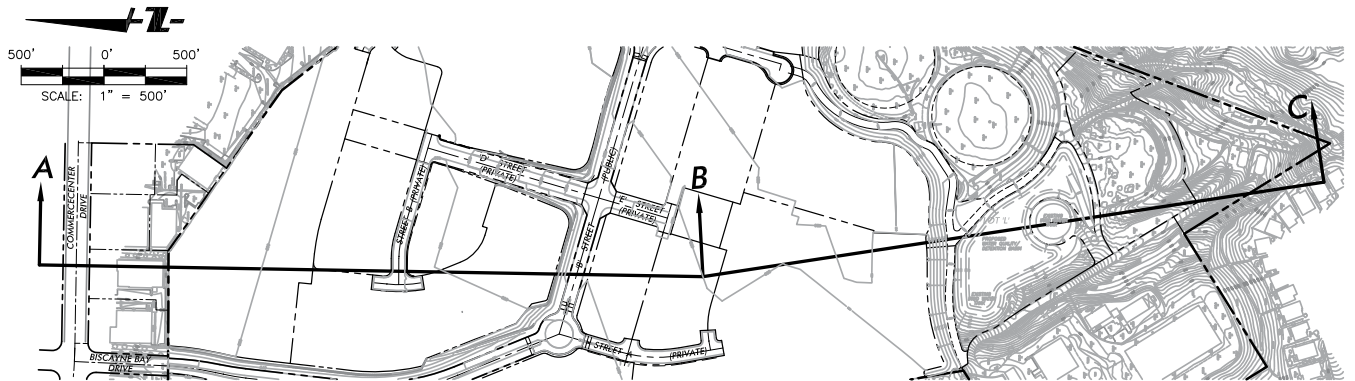
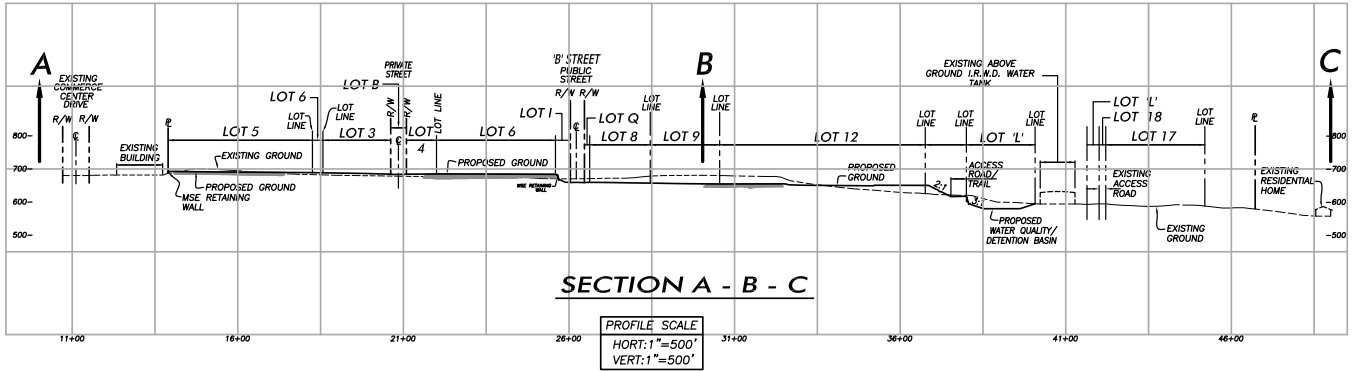

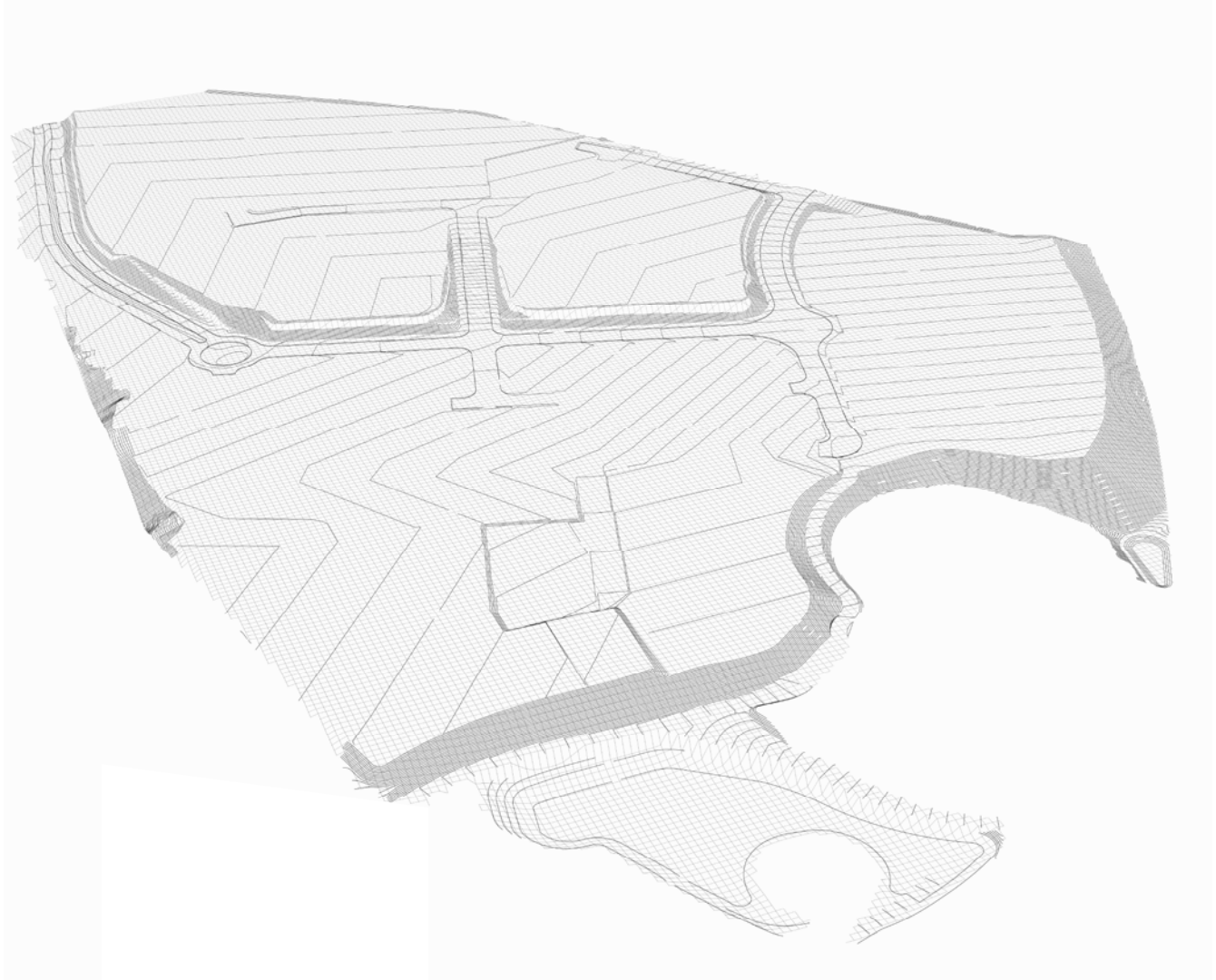

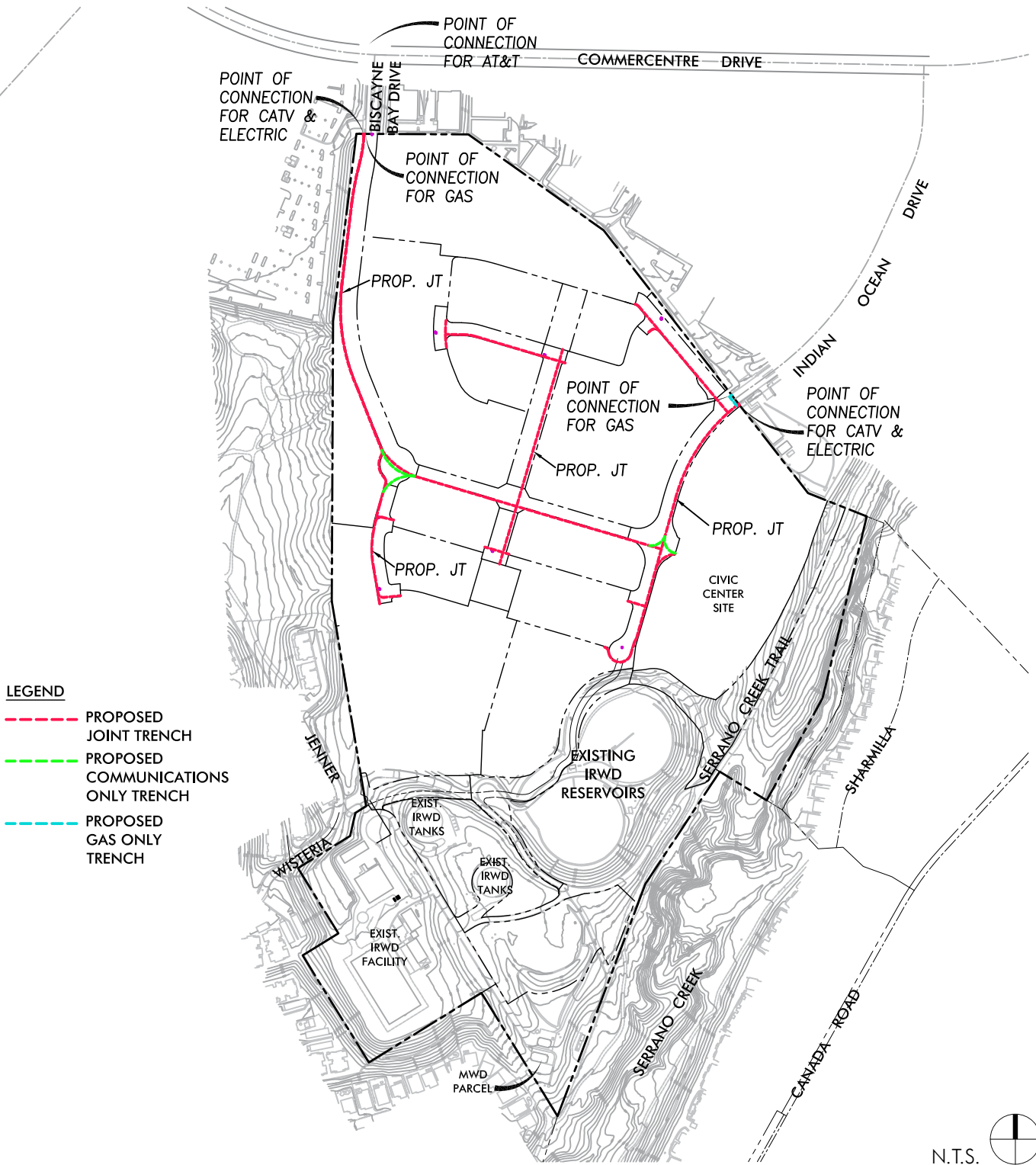

SERRANO SUMMIT AREA PLAN

COMMUNITY FACILITIES

5.7

Civic Center

An 11.9 gross acre site in Serrano Summit may be developed as a new civic center for the City of Lake Forest per the Public Facilities Overlay. Civic center land provided by the project developer will be offered and accepted pursuant to the Serrano Summit Development Agreement.

Schools

Saddleback Valley Unified School District is the school district serving the K-12 school needs of the Serrano Summit community. Schools within the vicinity of Serrano Summit that may serve the K-12 school level needs of the community include:

- Lake Forest Elementary School (21801 Pittsford Drive, Lake Forest)
- Rancho Cañada Elementary School (21801 Winding Way, Lake Forest)
- Serrano Intermediate School (24642 Jeronimo, Lake Forest)
- El Toro High School (25255 Toledo Way, Lake Forest)

The developer will pay school mitigation fees as required by the State of California and specified in the Serrano Summit Development Agreement.

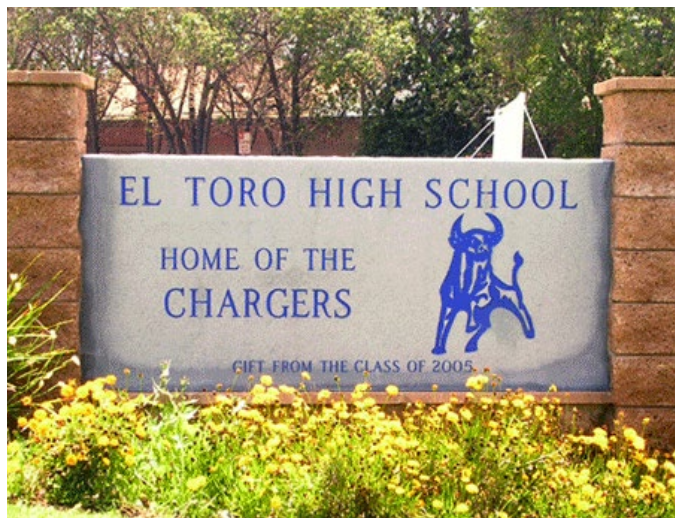

Police / Sheriff

Police services for the City of Lake Forest are provided by contract with the Orange County Sheriff's Department. The developers of Serrano Summit will pay the required impact fee for police services pursuant to the conditions of approval of any tentative tract map for development.

Fire

Fire services in the City of Lake Forest are provided by the Orange County Fire Authority. The developers of Serrano Summit will pay the required impact fee for fire protection services pursuant to the conditions of approval of any tentative tract map for development.

Library

The developers of Serrano Summit will pay the required library fees pursuant to the conditions of approval of any tentative tract map for development.

Solid Waste

Waste Management provides waste collection and disposal in Lake Forest. Waste Management will provide solid waste collection and disposal services to Serrano Summit.

Parks

Serrano Summit incorporates 6.1 acres of parkland including a 1.9 acre recreation center. The parkland and recreation center will be improved and dedicated by the project master developer to the City of Lake Forest pursuant to the terms contained in the Serrano Summit Development Agreement.

Other Public Facilities

The developers of Serrano Summit will pay the required impact fee for public facilities pursuant to the terms contained in the Serrano Summit Development Agreement.

TECHNOLOGY PLAN

5.8

The responsibility for enforcement of the following provisions shall be through the master developer.

Network Description

Developers should strive to implement the most advanced networks commercially available at Serrano Summit. Networks should be based upon technology that is commercially proven and stable for deployment in commercial environments.

Network refers to the assembly of components, software, and network management tools linked together in a single cohesive web for the purpose of effectively and efficiently transporting and switching all communications signals within Serrano Summit in a reliable and cost-effective manner.

Networks should be planned with four architectural objectives in mind:

1. The networks should be scalable; that is, easily and seamlessly scaled up or down, without interruption, to support increased or decreased users or volumes of traffic.
2. The networks should be open: that is, the networks employ an Open System Interconnection (OSI) design framework. The networks must have the ability to support any standard device attached to the network irrespective of the vendor or manufacturer.
3. The networks should be adaptable; that is, the network will need to adapt to the needs of any user, for any combination of voice, data, or image.
4. The networks must be evolvable; that is, the networks must employ a design concept recognizing the future will present technology innovations and user-community changes that cannot be foreseen today.

These four characteristics – scalable, open, adaptable, and employable – define the networks developers must deploy to serve Serrano Summit.

Infrastructure

Open Systems refers to an environment that is designed and constructed in a way that will allow

any set of hardware and software to operate on the system, if the hardware and software have been designed and built in compliance with Open Systems Interconnection (OSI) standards. OSI is an internationally accepted framework for standards of communication systems. OSI was developed by the International Standards Organization (ISO) and is the only internationally accepted framework of standards for communication between different systems made by different vendors. The OSI model organizes the communications process into seven layered categories. Each layer in the sequence ensures the operability of the next layer. The seven layers are:

- Layer 1 – The Physical Layer
- Layer 2 – The Data Link Layer
- Layer 3 – The Network Layer
- Layer 4 – The Transport Layer
- Layer 5 – The Session Layer
- Layer 6 – The Presentation Layer
- Layer 7 – The Application Layer

Implementation

Many implementation models have been attempted by developers to ensure their communities have access to world-class communications services. The method of implementation sought for Serrano Summit is as follows:

Strategic Partnering

This implementation practice calls for the developer to forge a collaboration with one or more service providers, whereby the provider(s) agree to deploy advanced infrastructure in exchange for establishing a business relationship that will convey a marketing advantage for the service provider. Normally, this marketing advantage comes in the form of an endorsement or co-branding. This strategy is principally employed where the developer has no interest in investing or establishing a competency in communications and technology, but trades the marketing support for advanced infrastructure. Strategic partnering can be employed for one or all communications services. Strategic Partnering is the approach most commonly employed in large master-planned communities and will be the approach used in Serrano Summit.

Residential Wiring Specifications

To take full advantage of an all-fiber network, developers at Serrano Summit must contemplate an inside-the-home wiring distribution system. This wiring standard is called a “structured” wiring standard or “smart home” wiring standard and is a requirement of all developers and builders at Serrano Summit. Each housing unit must meet this minimum standard, and the wiring system must be tested and certified, prior to securing the certificate of occupancy.

Transmission & Wireless Communication Towers

Transmission towers and wireless communication towers shall be prohibited in all planning areas within Serrano Summit, with the exception of Planning Area 19. Transmission towers and wireless communication towers are permitted pursuant to the regulations contained in Chapter 10, “Development Regulations,” of this Area Plan.

CIRCULATION

Section 6.0

November 2016



CIRCULATION

6.1

The circulation plan for Serrano Summit addresses both regional and local circulation requirements. The circulation plan also addresses the efficient movement of vehicular traffic through the community, as well as an environment for pedestrian movement and bicycle traffic. Reducing unnecessary reliance on the automobile as a primary means of travel throughout Serrano Summit is a fundamental objective of the circulation plan.

Regional access to the Serrano Summit project area is provided from the I-5 Freeway via Bake Parkway, an arterial roadway. Regional access is also available from the northeast by SR-241, a toll road. Commercentre Drive, a commercial street, provides access from Bake Parkway to the two collector streets that service the project — Biscayne Bay Drive (referred to as 'A' Street herein) and Indian Ocean Drive.

Serrano Summit is served internally by a network of public collector roadways and private local streets. There are three collector streets within the project area — Indian Ocean Drive, 'A' Street and 'B' Street. 'B' Street incorporates two roundabouts at either end. These roundabouts are designed to create a sense of arrival and provide traffic calming. 'D' and 'E' Streets are private streets.

New sidewalks and pedestrian linkages connecting residential neighborhoods, parks, and open space areas are planned within Serrano Summit. An off-street multi-use trail will connect the community with the Serrano Creek trail. The network of sidewalks and linkages planned for Serrano Summit will provide bicycle and pedestrian connectivity to all areas within the community.

Master Circulation Plan

Serrano Summit is accessible from Bake Parkway via Commercentre Drive via Indian Ocean Drive and 'A' Street (the planned new southern extension of Biscayne Bay Drive). Indian Ocean Drive and 'A' Street are connected together by a new collector street, 'B' Street. The planned Civic Center complex is located at the intersection of Indian Ocean Drive and 'B' Street. Exhibit 6-1, the "Circulation Plan"

establishes the hierarchy and general location of roadways within Serrano Summit.

The alignment of the internal circulation system planned for Serrano Summit is approximated. Final alignments will be established as part of the City of Lake Forest's approval of tentative maps.

'A' Street and 'B' Street

'A' and 'B' Streets are both Collector streets. The streets are designed with the following rights-of-way:

- 'A' Street: A divided street with a right-of-way width of 56 feet.
- 'B' Street: An undivided street with a right-of-way width of 41 feet. Both ends of 'B' Street are anchored by traffic roundabouts.

Indian Ocean Drive

Indian Ocean Drive is a Collector street with a right-of-way width that varies from 47.5 to 51.5 feet.

Exhibits 6-2 to 6-4 illustrate the cross sections for each of the above streets.

Private Drives and Alleys

'D' and 'E' Streets are undivided private streets with a curb-to-curb width of 36 feet.

Private drives and alleys within Serrano Summit will provide access and circulation throughout the community, distributing vehicular traffic from public collector streets into and through the residential neighborhoods. Private drives and alleys proposed for Serrano Summit are illustrated on Exhibits 6-6 to 6-8, and discussed below.

Traffic Calming / Roundabout

Serrano Summit incorporates design features including roundabouts within the residential neighborhoods to encourage drivers to proceed slowly and reduce traffic noise on street. These features contribute to more livable neighborhoods in which to walk, bike and drive.

Two roundabouts are planned at both ends of 'B' Street, as depicted in Exhibits 6-9 and 6-10. Exhibit 6-1 illustrates the planned locations of the two roundabouts. Roundabouts replace traditional all-way stops at intersections in order to provide even flows from side streets, slow traffic as drivers maneuver around the circle, reduce delays and resulting congestion, and provide opportunity for landscaping.

Streetscaping

The landscape concept for Serrano Summit is designed to contribute to a sense of the street system as a pedestrian protected area to promote slower traffic speeds. This can be achieved through landscaping adjacent to streets which combine the use of shade trees, shrubs and ground cover adjacent to sidewalks to create a more intimate streetscape.

Pedestrian Circulation

Pedestrian circulation will be provided throughout Serrano Summit by means of interconnected sidewalks. Sidewalks may be adjacent to the street, or may be separated from vehicular travel lanes by a landscaped parkway. Exhibit 4-2, "Master Plan of Parks, Trails & Open Space," illustrates the pedestrian and bicycle connectivity system within Serrano Summit. Exhibits 6-2 through 6-6 illustrate the typical sidewalk and trail improvements associated with the Serrano Summit roadways. A multi-purpose trail will tie into the Serrano Creek Trail.



Collector Street with Landscaped Parkway



Local Street with Curb-Adjacent Sidewalk

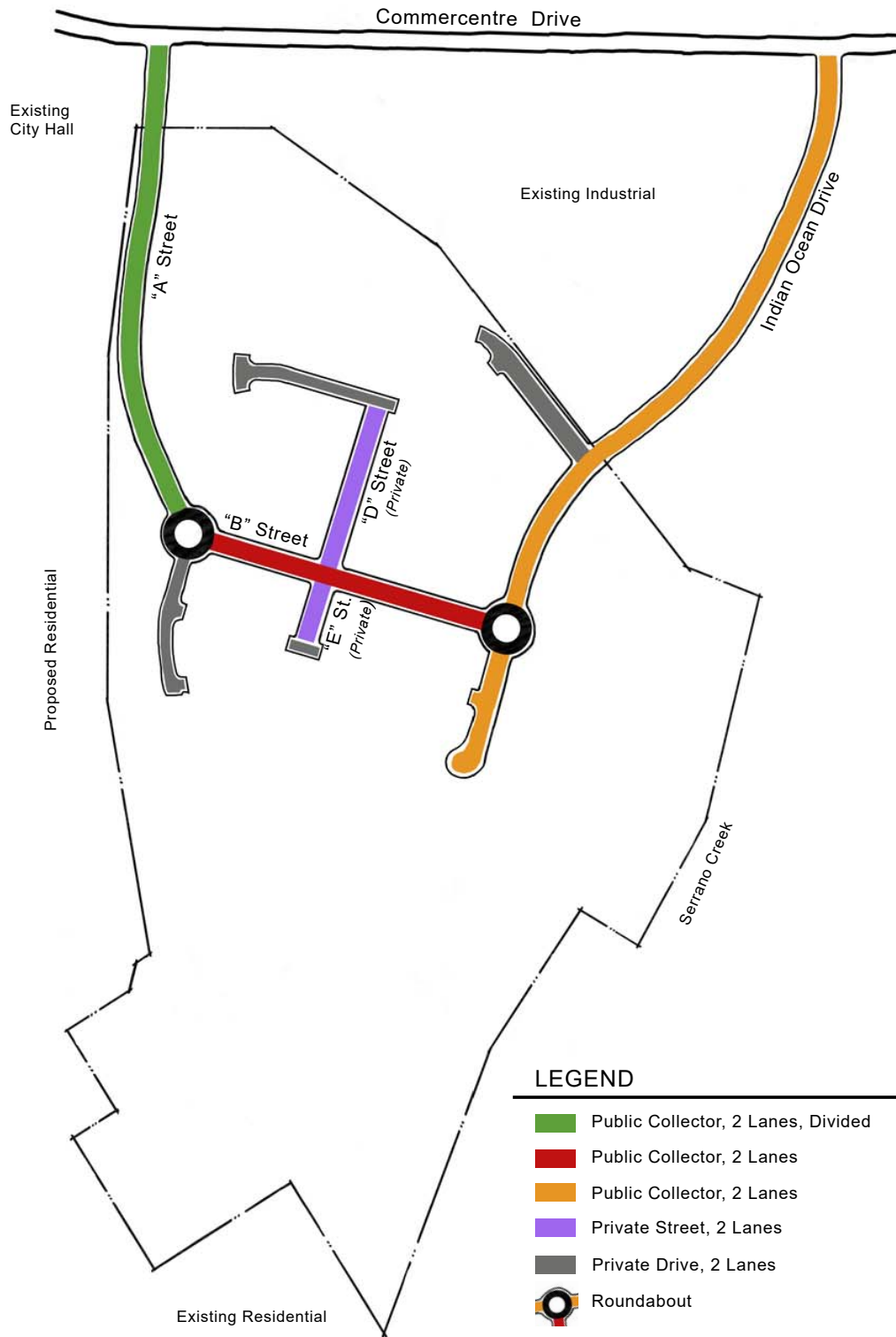

N.T.S. 

General Circulation System Development Standards

- Any application for any subdivision within the Serrano Summit boundaries shall comply with the design of the project's master planned infrastructure within the final map boundaries.
- Each subdivision shall comply with the on-site and off-site street improvement recommendations and mitigation measures outlined in the subsequent traffic studies prepared for each individual development project and EIR level mitigations adopted as part of the approval of this Area Plan.
- All major internal roads within Serrano Summit shall be constructed per the cross sections included as Exhibits 6-2 through 6-9 in this Area Plan, or as approved by the City of Lake Forest.
- Landscape improvements for roadway rights of ways shall be in accordance with the roadway landscape treatments described in Section 9 of the Serrano Summit Area Plan, "Landscape Design Guidelines."
- Public Utility Easements (PUE) are allowed on the outside of a street right-of-way. PUE are located adjacent to 'A' and 'B' Streets and private 'A', 'B', 'C', 'D' and 'E' Streets, 3' outside of property lines.
- All intersection spacing and/or access openings shall be as shown on the circulation plan, or as approved by the City of Lake Forest.
- Any landscaping within public road parkways, medians, slopes, walls and roundabouts will be maintained by the Master Homeowners Association (excluding the east side parkway of Indian Ocean Drive).
- Bike lanes developed as part of the Serrano Summit project shall be reviewed and approved by the City of Lake Forest, if located within public right-of-way.
- All tentative tract map(s) shall provide for adequate emergency and fire access per the Orange County Fire Authority (OCFA) requirements.

'B' STREET PLAN VIEW & SECTION

EXHIBIT 6-3

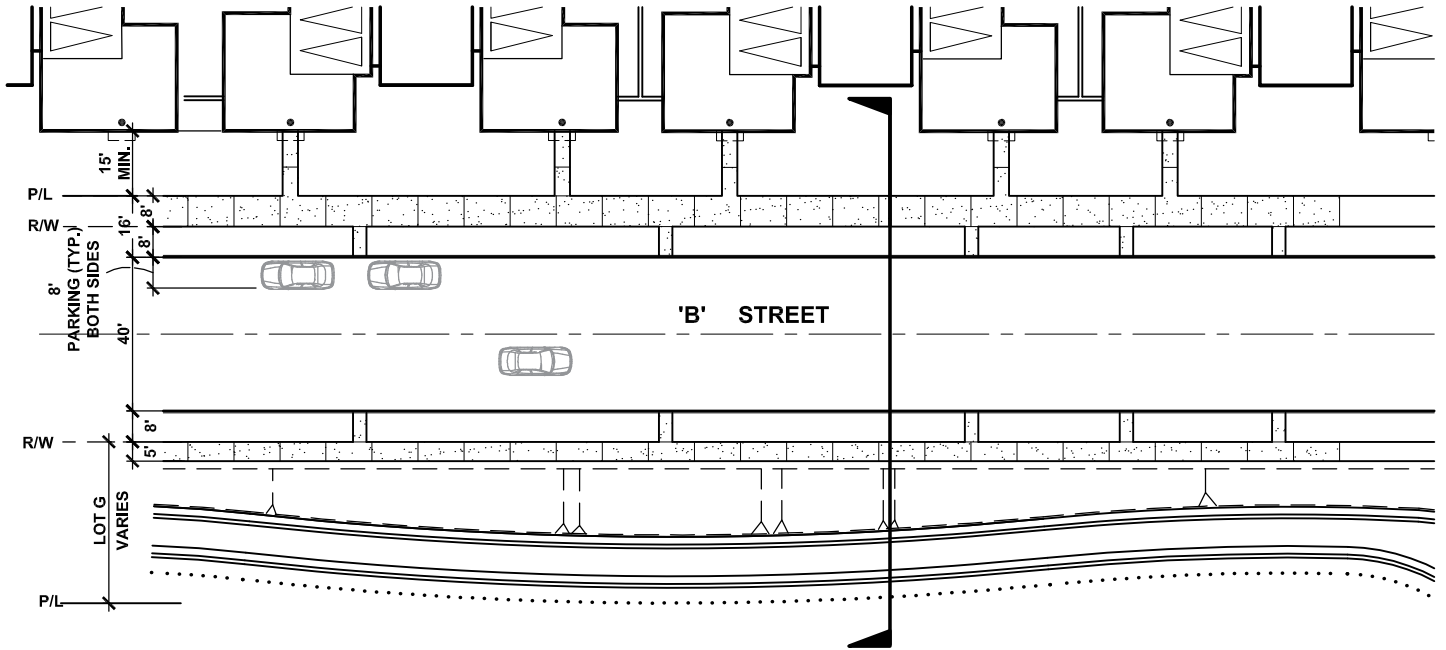

PLAN VIEW

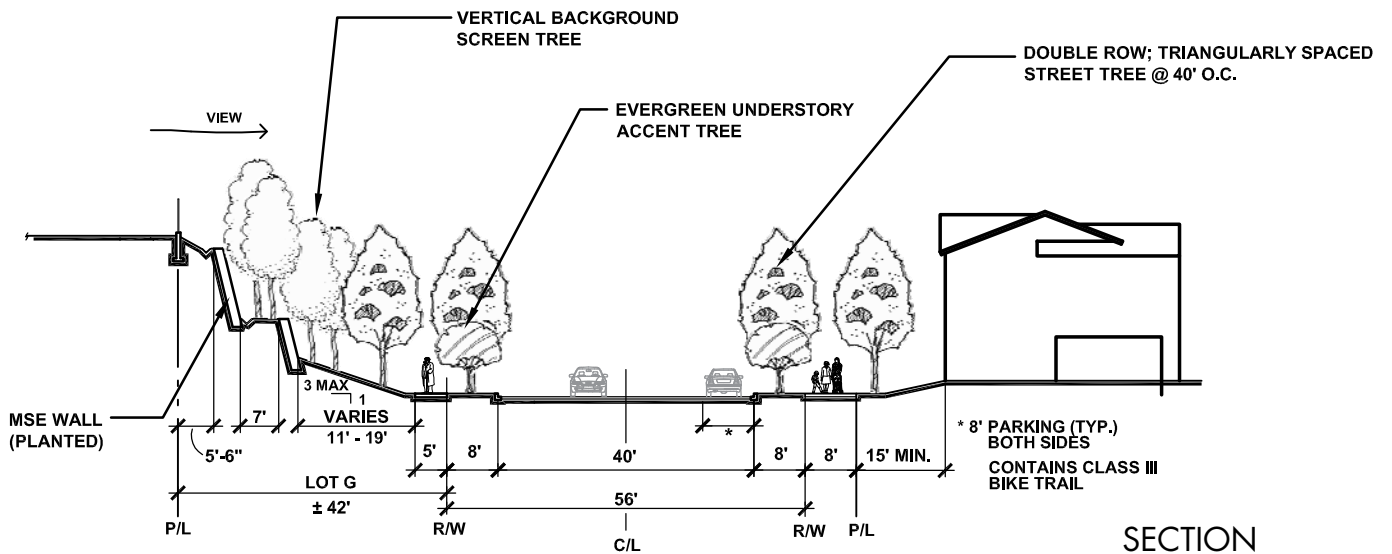

SECTION

INDIAN OCEAN DRIVE PLAN VIEW & SECTION

EXHIBIT 6-4

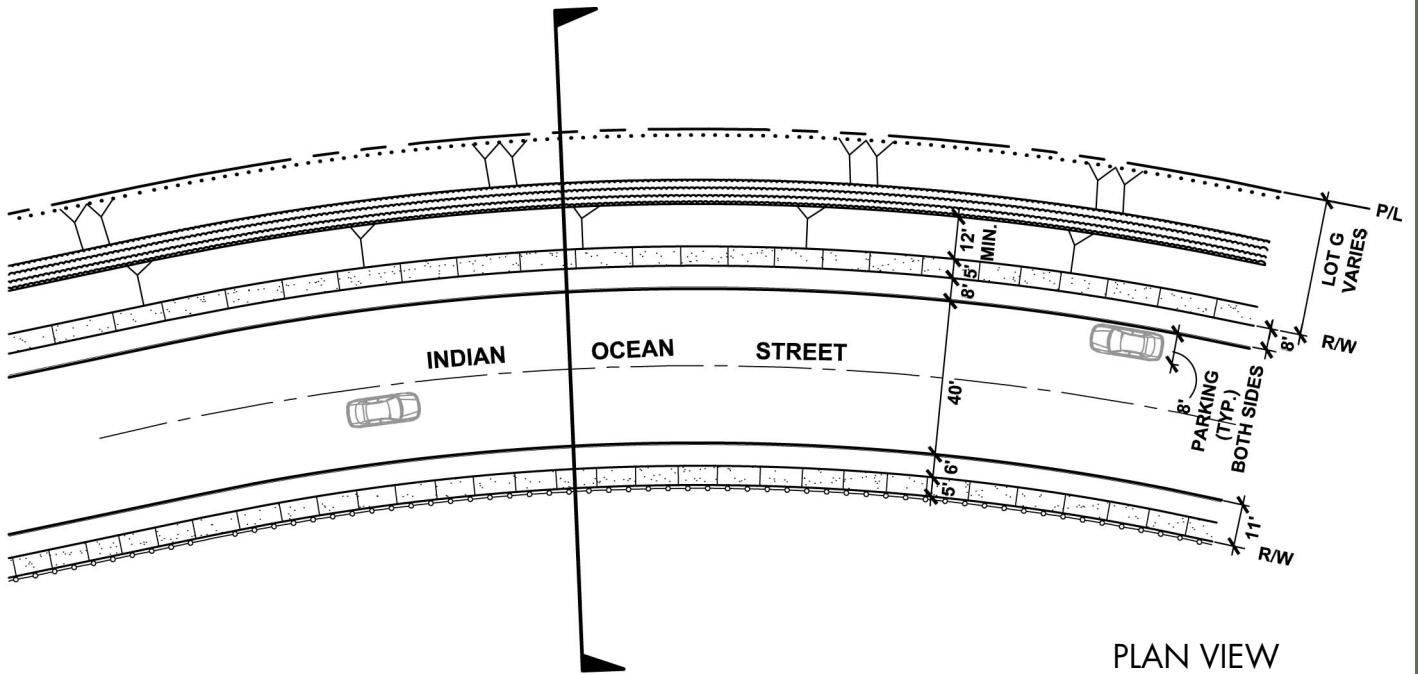

PLAN VIEW

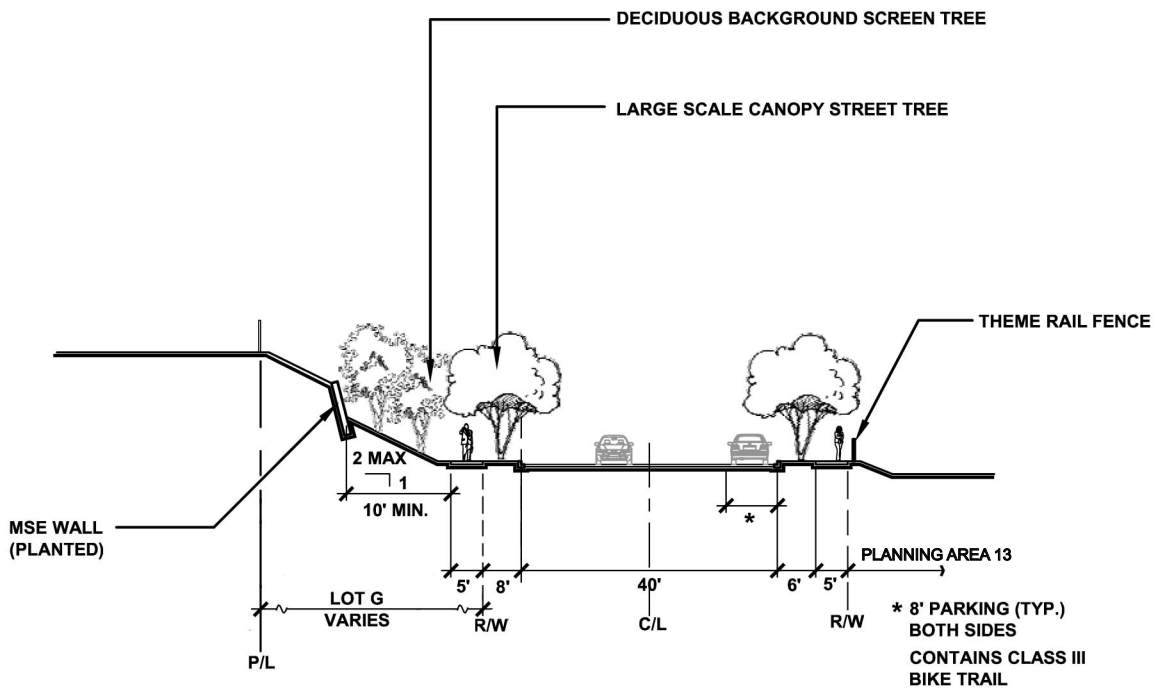

SECTION

'D' STREET PLAN VIEW & SECTION

EXHIBIT 6-5

(PRIVATE)

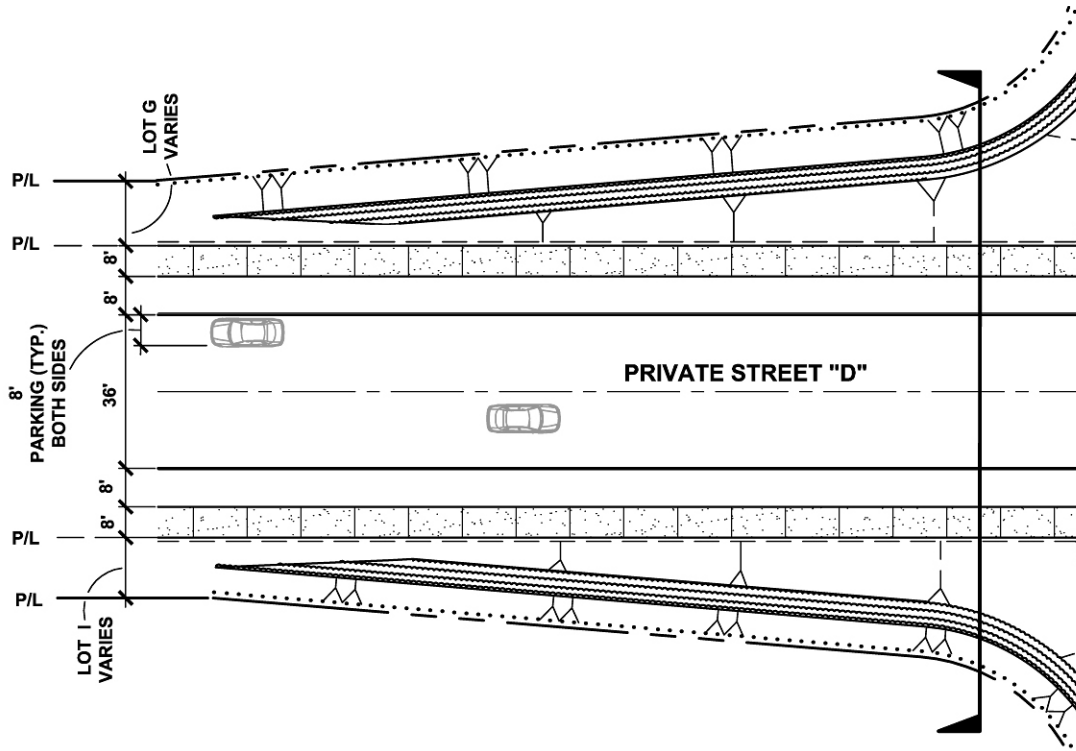

PLAN VIEW

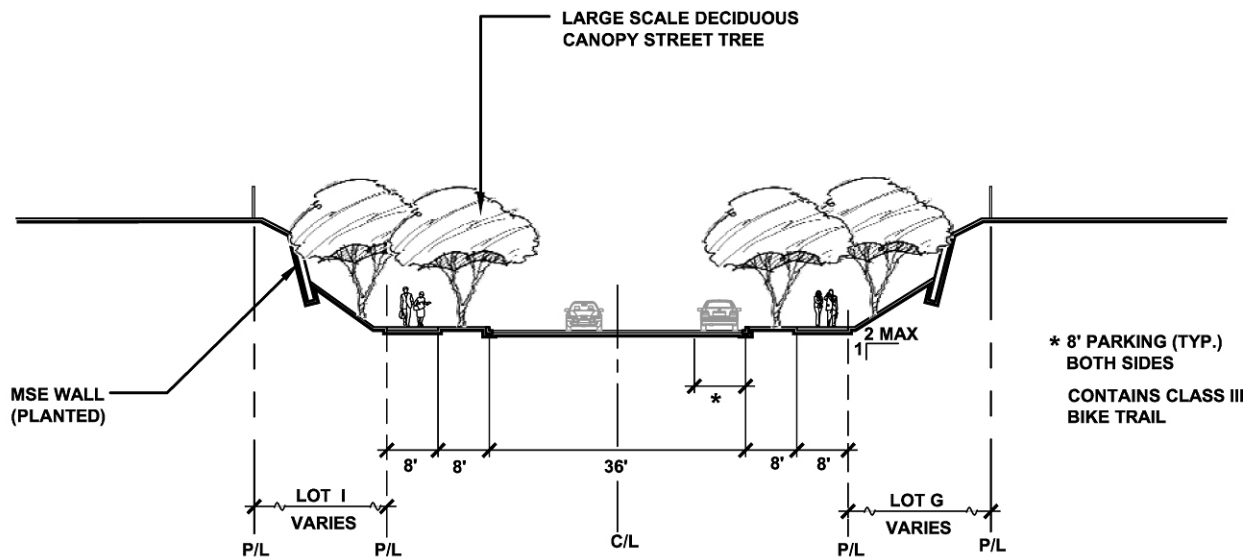

SECTION

PRIVATE LOCAL STREET PLAN VIEW & SECTION (WITH ON-STREET PARKING)

EXHIBIT 6-6

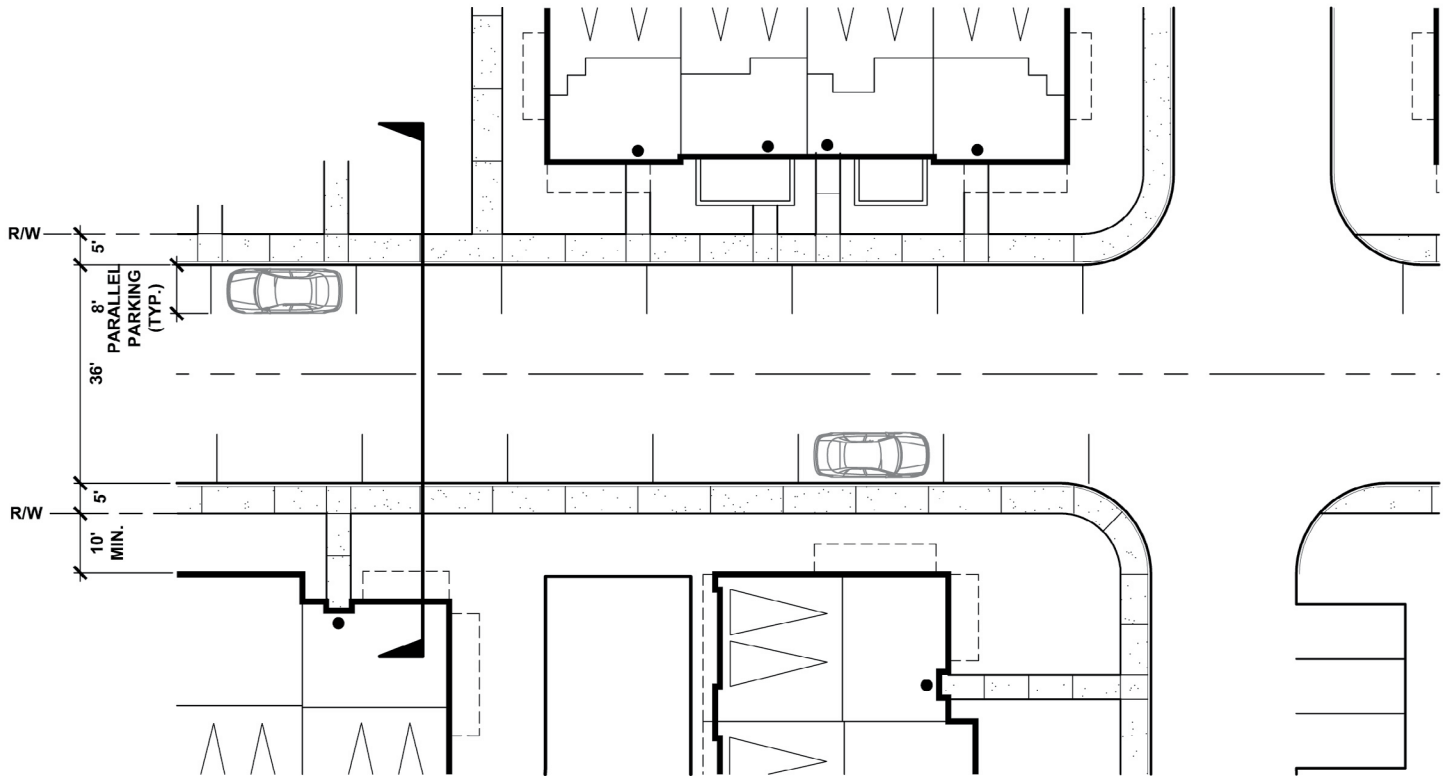

PLAN VIEW

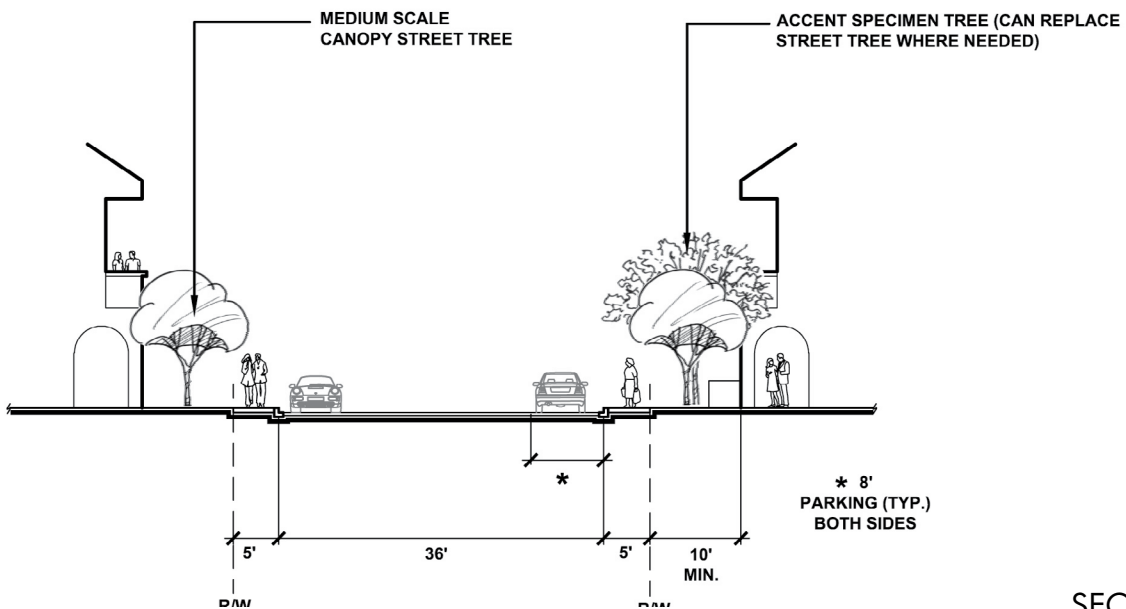

SECTION

PRIVATE ALLEY DRIVE PLAN VIEW & SECTION - SINGLE FAMILY RESIDENTIAL

EXHIBIT 6-7

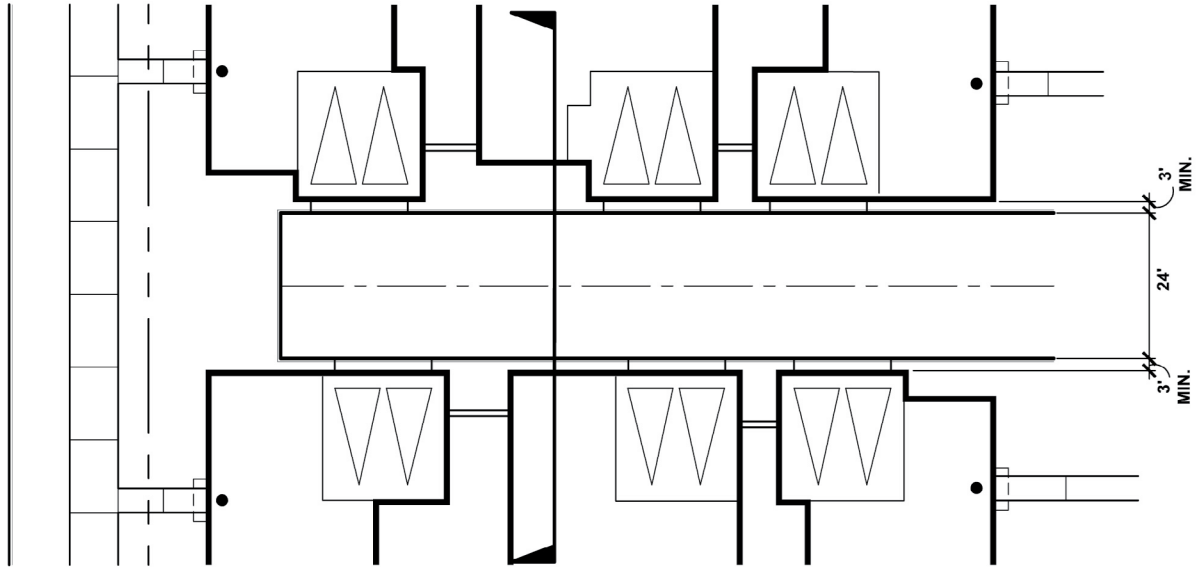

PLAN VIEW

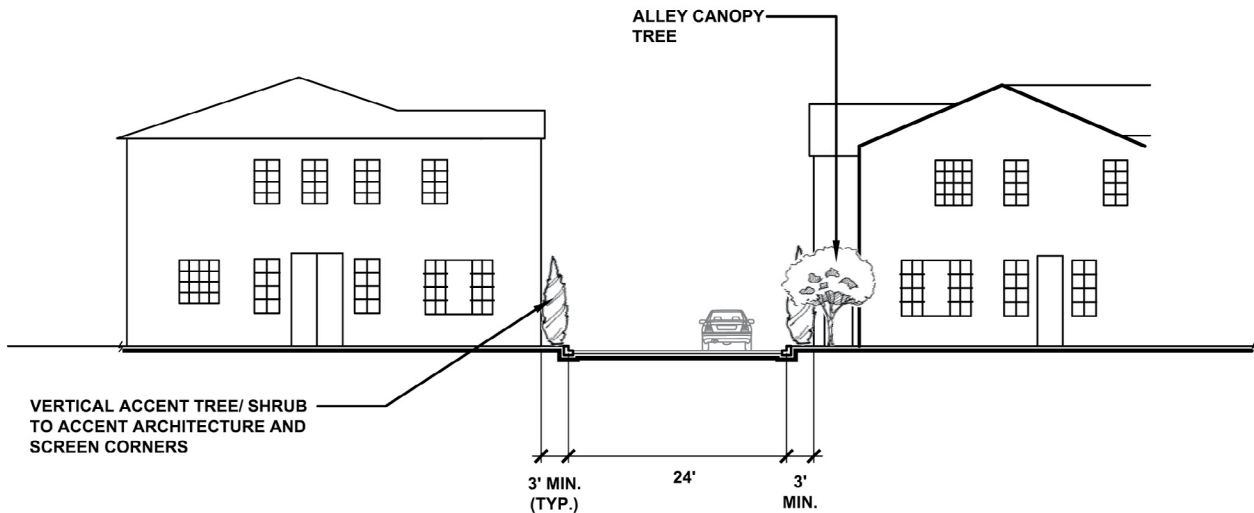

SECTION

PRIVATE ALLEY DRIVE PLAN VIEW & SECTION - TOWNHOME

EXHIBIT 6-8

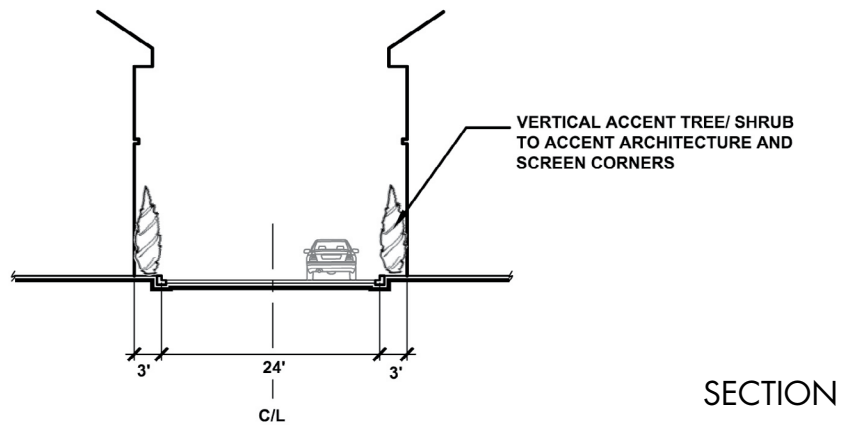
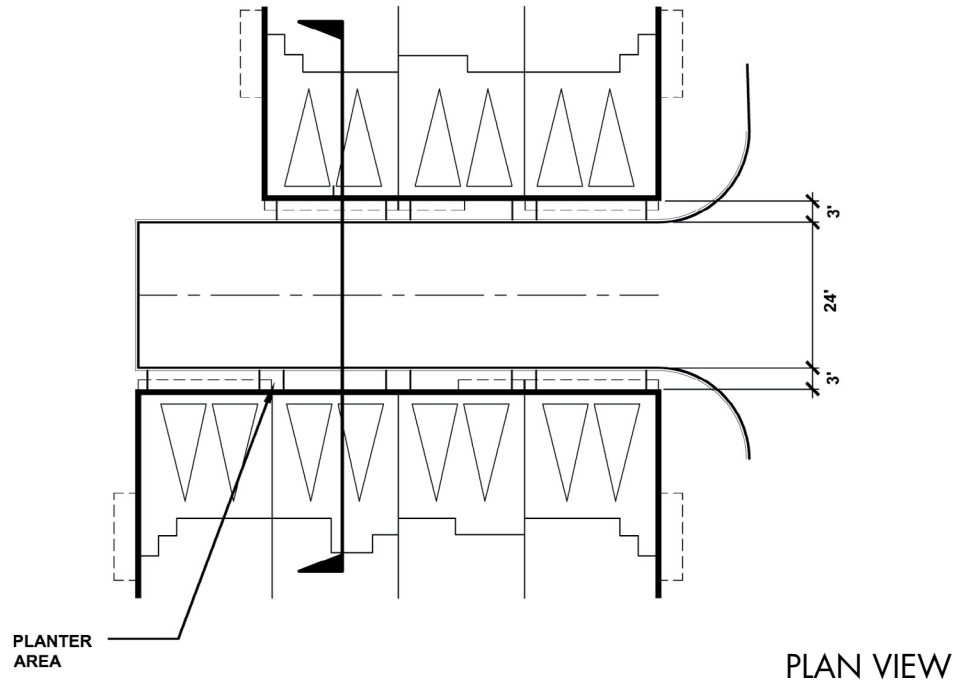

ROUNDBABOUT AT 'A' STREET & 'B' STREET

EXHIBIT 6-9

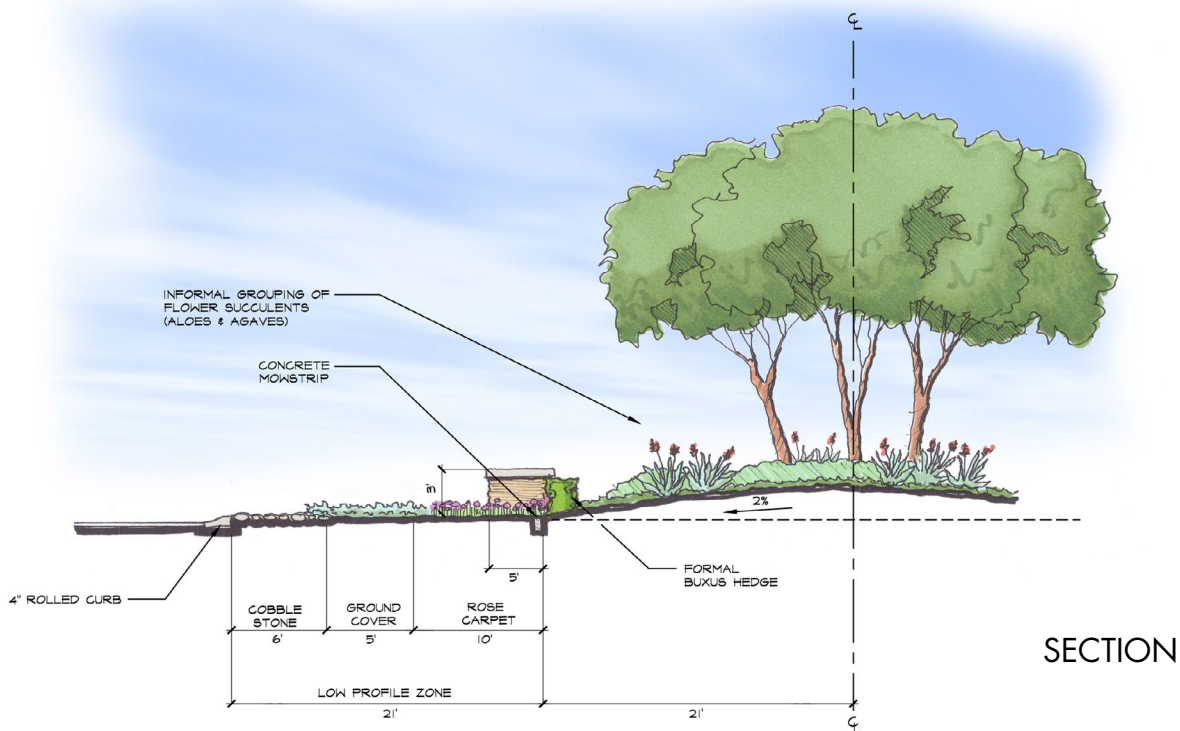
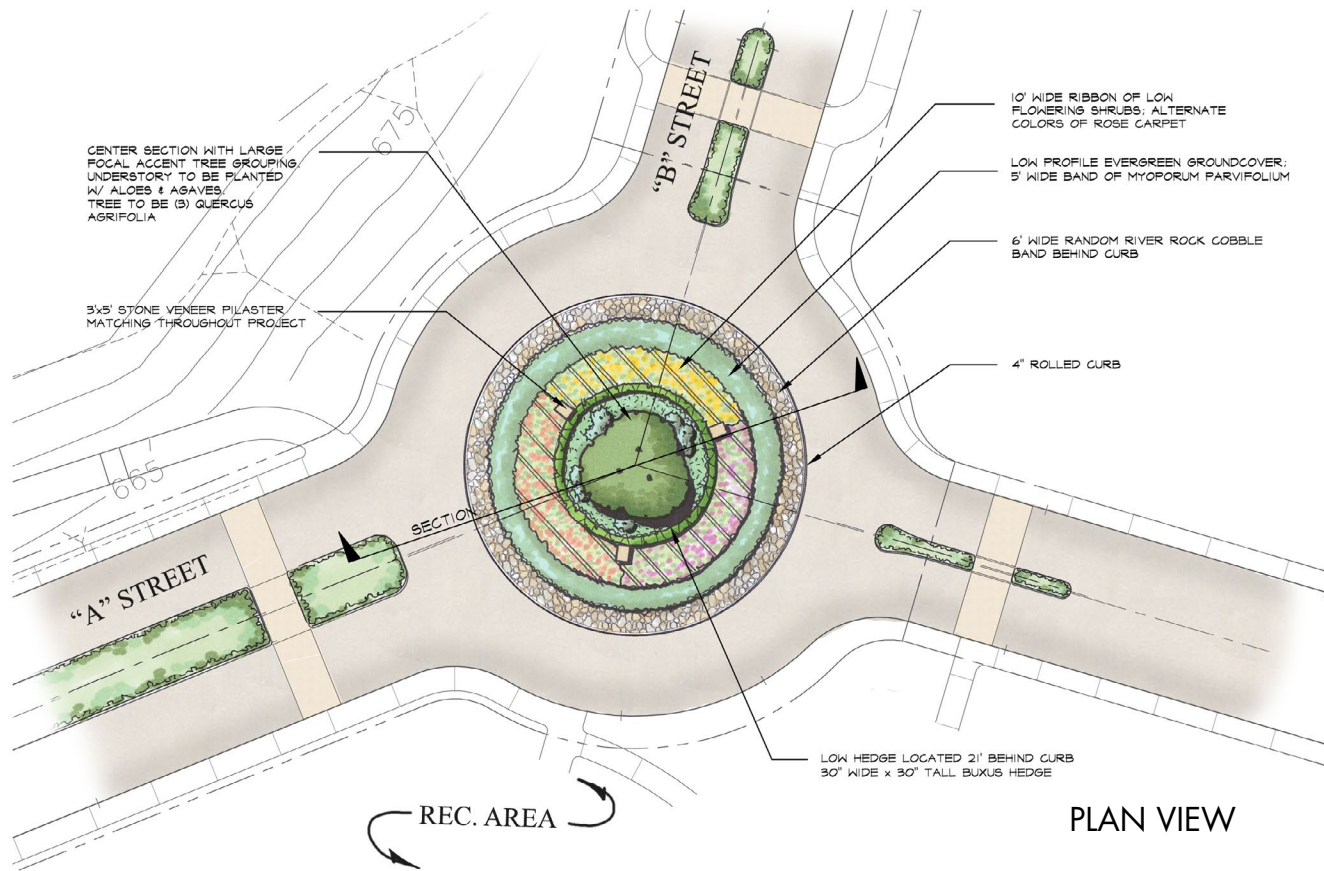

ROUNDBABOUT AT 'B' STREET & INDIAN OCEAN DRIVE

EXHIBIT 6-10

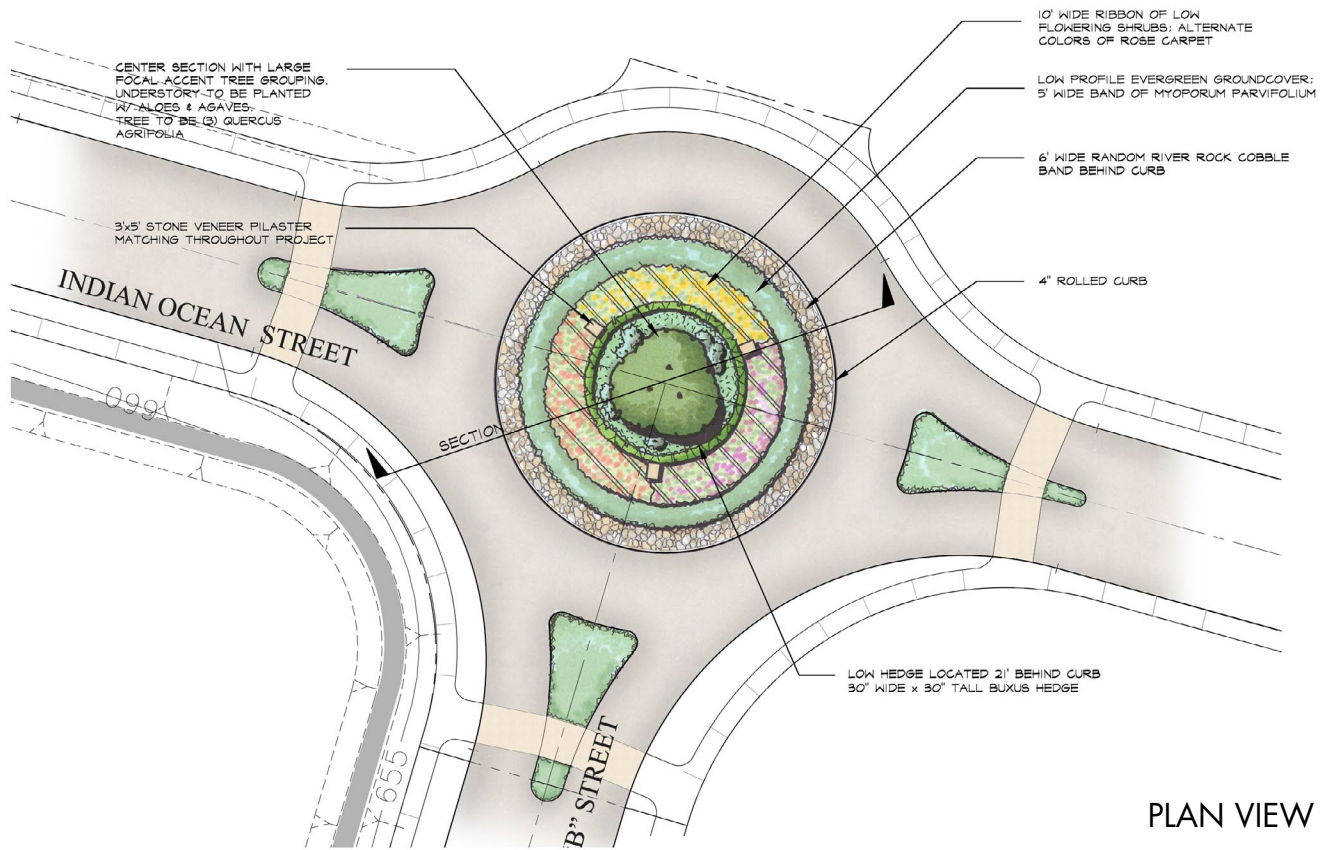

PLAN VIEW

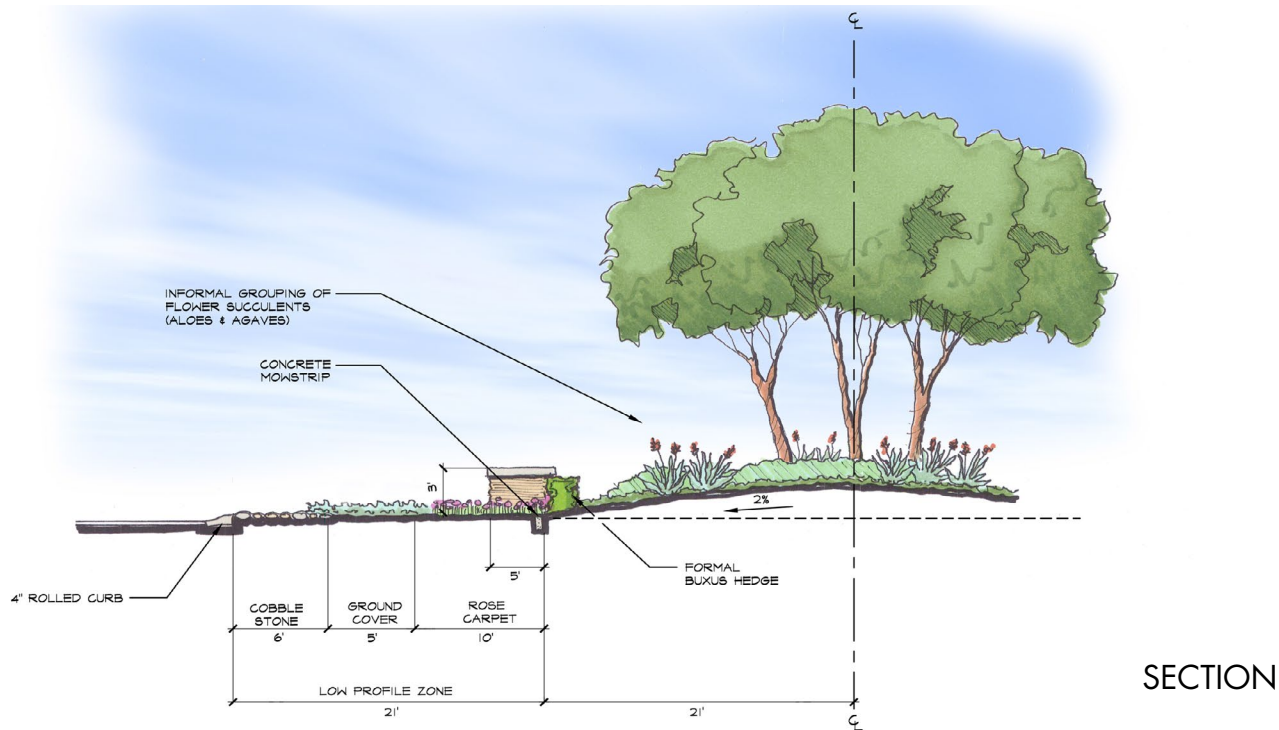

SECTION

RESIDENTIAL DESIGN GUIDELINES

Section 7.0

November 2016



DESIGN GUIDELINES INTRODUCTION

7.1

The Design Guidelines sections of the Area Plan are designed to guide development within Serrano Summit and will incorporate the principles of Smart Growth, Sustainability, and Green Design. The Residential Design Guidelines begin with Neighborhood Planning concepts, and are then organized into Architectural Guidelines by four (4) primary housing types - Single Family Detached (SFD), Single Family Detached Enclave (SFD-E), Single Family Attached (SFA), and Multi-Family Attached (MFA). Section 8 of the Area Plan includes design guidelines for the planned Civic Center.

The Serrano Summit Community Design Guidelines have been prepared to ensure that the vision elements of the plan are well articulated and implemented throughout the project site by providing planning, architectural, and landscape design criteria.

The Design Guidelines will ensure implementation of the Area Plan goals and objectives for development. Such goals include:

- Incorporate sustainable features into all aspects of the community.
- Create a strong community identity for Serrano Summit
- Plan for a circulation system serving motorists, bicyclists, and pedestrians
- Create livable residential neighborhoods.
- Provide for a range of housing types to meet the needs of a variety of economic segments.
- Develop a land use plan responding to the environmental conditions of the area.

Sketches and graphic representations contained herein are for CONCEPTUAL PURPOSES ONLY and are to be used as general visual aids in understanding the basic intent of the guidelines. They are not meant to depict any actual lot or building design. In an effort to encourage creativity and innovation, the guidelines express “intent” rather than “absolute.”



Residential Design Fundamentals

The community of Serrano Summit is designed to promote a healthy and socially connected lifestyle for its residents through the creation of tightly integrated neighborhoods which maximize distance views, provide connections to trails, parks, and the rich open space amenities of the Serrano Creek Corridor. Diversity and creativity in design are encouraged within an underlying harmony of compatible styles and appropriate details. Important elements of design within Serrano Summit include:

- Formal street pattern with alternative routes to each destination.
- Reinforcement of community identity through architectural design.
- Integration of a pedestrian-friendly circulation system.
- Residential neighborhoods designed at a “human scale” and oriented to pedestrian activity.
- A variety of housing opportunities addressing multiple lifestyles.
- Homes that incorporate energy saving materials and techniques, whenever feasible and cost effective.



COMMUNITY RECREATION & COMMON FACILITIES

7.2

Serrano Summit has been developed around the central idea of providing a variety of resident friendly elements that promote a healthy, vibrant community dynamic. These elements include common recreational facilities such as a pool, clubhouse, and other facilities as appropriate to the scale and activity of each community neighborhood. Common facilities act as a socializing and gathering place within the neighborhood.

The following elements should be considered when designing for such facilities:

1. The community recreational center building should serve as the focal point of the community and should exhibit a high level of quality design with attention to detail on all readily visible sides.
2. Community pedestrian connectors such as open space, paseos, and sidewalks should connect with the "Clubhouse/Recreation Center."
3. All architectural elements within the community center and common facility (community connectors), such as street furnishings, benches, lighting, and trash receptacles should be consistent with the selected overall themed character of the community.

The Common Facilities may include the following amenities:

- Jogging/walking paths/trails
- Natural open space
- Neighborhood parks
- Dog park
- Seating node
- BBQ node

The Clubhouse/Recreation Center in Planning Area 14 may include the following amenities:

- Clubhouse building
- Pool
- Spa
- Tot/kid pool or water play area
- Sun deck
- Shade oasis
- Tot lot
- Restrooms and showers



NEIGHBORHOOD PLANNING DESIGN GUIDELINES

7.3

Introduction

Site Planning Concept

The goal of the Serrano Summit Area Plan is to integrate a variety of housing types into one cohesive neighborhood fabric. The benefits are two-fold: such integration creates diversity and enables a broad spectrum of homes within the community.

Neighborhood residential components may include:

- Single family detached neighborhoods, from conventionally-loaded homes to court-loaded enclave homes. The ability to mix-and-match these home types throughout a neighborhood allows for small, diverse pockets of single family detached residential design.
- Single family attached neighborhoods which often resemble small villages, with the buildings generally oriented around public spaces such as open areas and recreational amenities. Buildings often form linear edges or green courts, creating opportunities for pedestrian connectivity.
- Multi-family attached neighborhoods are generally oriented around public spaces, such as open areas and recreational amenities, with opportunities for pedestrian connectivity.

How to Use the Guidelines

The following guidelines have been written to guide builders and architects in creating site plans and architecture that is consistent with the community framework and planning principles of Serrano Summit as explained in this Area Plan. Sketches and graphic representations shown herein are intended to assist in defining the design fundamentals, while allowing for and encouraging individual interpretation and creativity.

Site Plan Design

Preserving Views

Careful building placement and street orientation can help protect privacy, views, and the visual quality of the community. Where feasible, preservation of the privacy of surrounding residential homes, as well as capturing long-range vistas to the south, east, and west, is encouraged.

Smaller Parcels

One of the Serrano Summit project's goals is to create neighborhoods that promote walkability and pedestrian accessibility of neighborhoods. By creating smaller residential parcels, builders can create a less "mass produced" environment with a more intimate character.

Community Circulation

The overall circulation concept for Serrano Summit emphasizes both vehicular and pedestrian connectivity. The community "spine" road (referred to hereinafter as 'B' Street) provides vehicular access to most of the development parcels within the master plan and features two roundabouts at either end of the roadway. 'B' Street also features pleasant walkways set within shady landscape zones. Together, these design features provide for walking between neighborhoods, as well as to the community recreation area, civic center, on-site parks, and other open space amenities.

Gated Neighborhoods

Gated neighborhoods are permitted in all residential areas of Serrano Summit at the discretion of the project master developer, the builder of each tract and the City of Lake Forest. If provided, gated neighborhoods are not required to have a street connection to an adjoining parcel unless necessary for secondary access, drainage, utility connections, and/or emergency egress; however, gated neighborhood must at least provide a pedestrian connection to adjacent planning areas.

Parcel to Parcel Connections

Connectivity within Serrano Summit will enhance the community feel and encourage utilization of open space and community amenities. To heighten the connectivity of Serrano Summit, at least one street connection is required between adjacent non-gated parcels. Pedestrian sidewalks shall be incorporated into the street pattern connection. Builders must coordinate parcel to parcel connections with the Master Developer and one another. However, where the street pattern of one parcel is previously established, the following parcel shall build their street pattern off the existing connection.

Parcel Connections to Streetscape, Paseos & Open Space

Within Serrano Summit, pedestrian connectivity from the residential neighborhoods to recreational amenities must be provided (See Exhibit 4-2, Master Plan of Parks, Trails & Open Space). These pedestrian linkages can be located in paseos (greenbelt areas that are separate from the vehicular circulation system). In addition, pedestrian linkages include sidewalks adjacent to public and private streets. There is also a multi-use trail connecting the Civic Center site to the open space. Together these linkages promote a strong pedestrian orientation to Serrano Summit, and provide the opportunity for alternative modes of travel.

Building Orientation for Single Family Attached and Multi-Family Dwellings

Building orientation for single family attached and multi-family dwellings is an important element in site design. Because of the nature of the housing type, most attached dwelling floor plans offer little private outdoor space. Therefore, the public areas become increasingly important as they provide the necessary outdoor space for recreation.

- Where feasible, buildings should be oriented in a manner which creates open space pockets and opportunities for recreational nodes.

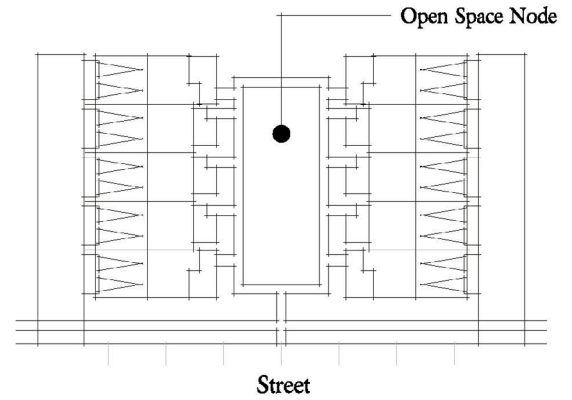

- Front entries should face public edges, whether open space pockets, paseos, or streets.

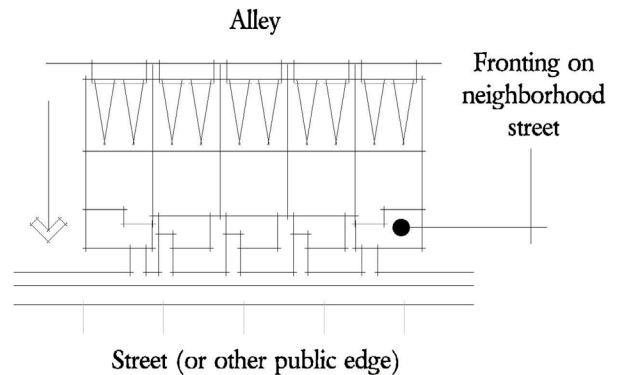

- Interconnecting walkways between buildings are encouraged.

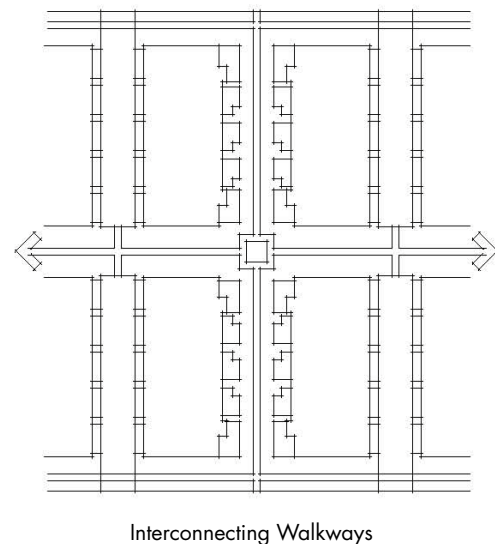

Plotting Standards

Floor Plan Variation

Single Family Detached and Enclave Dwellings

Single family dwellings should be plotted in a manner which provides variety in scale and architectural massing within a block. Variety not only provides visual interest to the neighborhood design, but it also provides each home with an identity. To achieve variety at Serrano Summit, several elements should be considered in the design of neighborhoods. Homes should offer a variety in floor plans, roof designs, materials, colors, garage orientations, outdoor living, and style-appropriate architectural detailing.

- Each neighborhood shall have a minimum of three floor plans for each single-family housing type (different plans are defined as those with significant variation in floor plan, garage access, and massing);
- Each of the floor plans must offer a minimum of three different architectural styles; and
- For single family detached homes, no more than two dwelling units with the same floor plan shall be plotted adjacent to one another. In addition, the floor plans shall be reversed and shall provide different elevations and color schemes to avoid a repetitious street scene.
- For enclave dwellings, no more than three dwelling units with the same floor plan shall be plotted adjacent to one another. For enclave homes, adjacent units shall be a different elevation and color scheme.

Single Family Attached and Multi-Family Dwellings

Attached and multi-family dwelling neighborhoods should offer a mix of floor plans and building types. Building type is defined as a composition of floor plans with a building massing that is distinguishable from other buildings within the neighborhood. This includes, but is not limited to, buildings with stacked flats, townhomes of varying sizes and orientations, and a mixture of these unit types.

- Attached and Multi-Family Communities
 - ~ *A minimum of two building types are required for each neighborhood, and*
 - ~ *A minimum of two floor plans is required for each building.*
 - ~ *Unit plans may be repeated within building types.*

- ~ *Provide at least one architectural style and two elevations or color schemes for that style per residential building type.*

Privacy

Privacy is an important consideration in residential site planning, especially when buildings are plotted with minimal side yards. Thoughtful site planning, landscaping, and other design techniques should be used to preserve privacy, where feasible.

Visible Edges

Neighborhood identity is closely tied to its interaction with community streets, open space networks and edge conditions. To maintain the visual quality of Serrano Summit, the thematic community streetscapes and open space edges along the perimeter of each development parcel have been addressed in this section.

All homes and buildings located along prominent perimeter edges shall incorporate architectural enhancements to elevations exposed to the community streetscape or open space areas as detailed in this section.

Community "Spine" Road Edges

To the extent practical, parcel edges along 'B' Street shall have front or side elevations that are exposed to the perimeter master plan streetscape. This condition can be satisfied in one, or a combination of, the following ways:

"Front" Elevations

"Front" elevations include homes or plotting conditions where the front elevation (or front door) is exposed to the edge. This includes the front or corner side elevation of rear loaded and enclave homes. In this condition, walls or fences, if any, may be located between buildings only; provided, however, that front patio walls up to 42" in height are permitted.

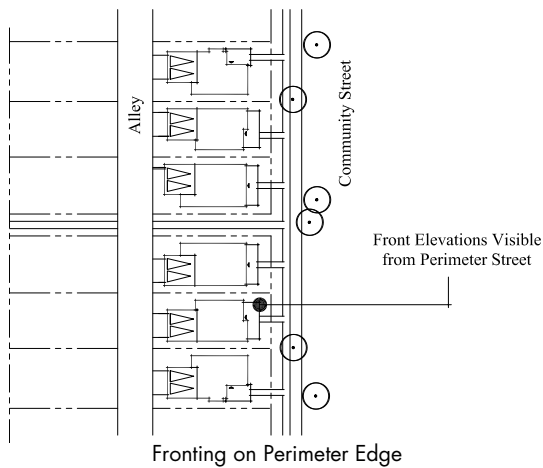

Other Visible Perimeter Edges

In other cases where a non-front elevation of a home or building faces a visible perimeter edge, the elevation shall be articulated in an appropriate manner. Such dwellings may incorporate the elements listed below.

Varying Rear Setbacks

Rear elevations adjacent to perimeter edges should provide some undulation in building placement and massing. This can be achieved through massing breaks or staggered setbacks between multiple homes:

- Staggered wall planes on an individual house with a minimum 2' offset, or
- Staggered rear setbacks on adjacent homes with a minimum 2' offset

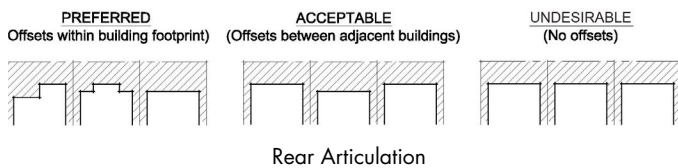

Rear elevations may have no setback offsets if found to be appropriate with the overall theme of the neighborhood and when effectively complemented by sufficient landscaping.

Variation of Roof Planes

When appropriate to the architectural style of the home, a variety of roof forms is encouraged, including

gable, cross-gable, hip and clipped hip elements, or shed roofs.

Architectural Enhancements

Elevations of multi-family buildings visible from perimeter edge conditions should be designed similarly to the other elevations of the building.

Required Elements:

- Wrapping of materials from front elevation
- Trim on all other windows (as appropriate to style)
- Window grilles to match front elevation (if applicable)

In addition to the above, rear and side elevations that are visible from parks and streets shall also include architectural features from the list below.

Select at least two of the following:

- Offset wall planes (Minimum offset: 2')
- Articulation
- Roof plane breaks
- Color blocking
- Shutters on second-story windows
- Introduction of accent building materials and colors
- Introduction of accent elements such as outlookers, and decorative grille work, consistent with the front elevation
- Other similar features that provide articulation to the visible side or rear elevations.

Also, all rear and side elevations shall include the following architectural features:

- Trim on windows
- Accent colors
- Articulation (rear only)

Visible Corners

Corners are formed where two streets or paths intersect, thus making two sides of a corner dwelling visible—the front and the corner side. Where this occurs in single family detached neighborhoods, exposed corner side elevations should be designed to an appropriate level of detail as the front elevation to present similar quality elevations on both streets.

In addition, the following architectural enhancements should be incorporated into the design of homes plotted on visible corners:

- Open side yard landscape treatments;

- Building pop-outs and recesses;
- Roof plane breaks;
- Accent colors, materials and detailing; or
- Other similar features which enhance and provide articulation to the visible side elevation.

Garages, Driveways & Parking Areas

De-Emphasize Garages; Architecture-Forward Plans

When addressing the streetscene in single family detached communities, residential garages should be positioned to de-emphasize their visual impact. This will allow the active, visually interesting features of the house to dominate the streetscape. Where feasible to the home type, garages should be paired.

Garages may be sited in several ways:

- Recessed (shallow, medium, and deep)
- Corner lot with side-street entry garage
- Forward swing-in garage (53' or wider lots)
- Split garages
- Lane-loaded garage
- Detached garages
- Garage forward

Garages for enclave homes should be located off of a court. Front homes within an enclave may have garages which take access directly from the street as well as the court.

Garages for single family attached and multi-family buildings may be rear- or front-loaded, and may exhibit a variety of siting conditions, dependent on the building type.

(See Section 7.4, Architectural Design Guidelines, for garage design criteria)

Driveway & Parking Criteria

Minimum driveway lengths shall be either be five feet or less in length to discourage parking in the driveway or 18 feet or greater in length to accommodate parking in the driveway.

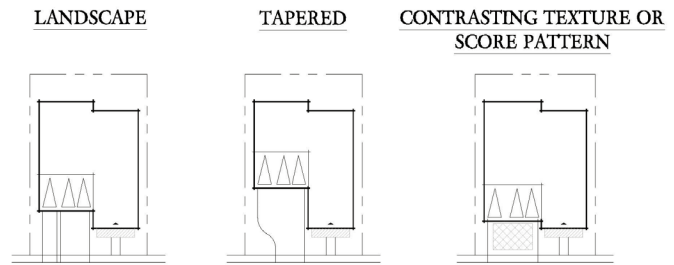

Driveway Variety

Note: Front entry driveways that are 16' in width or less do not require enhancement.

The maximum width of a driveway at the street for a turn-in garage shall not exceed 16'. The distance from the face of the garage door to the side yard lot line shall be a minimum of 28' (22' pavement and minimum 2' apron).

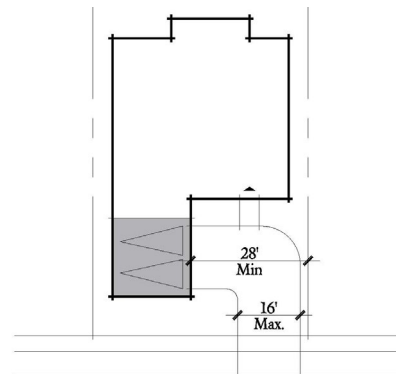

Turn-In Garage - Driveway Dimensions

Detached Garage Buildings & Carports

Special consideration should be made for the location of detached garage buildings and carports. In general, continuous carports at building entries should be discouraged.

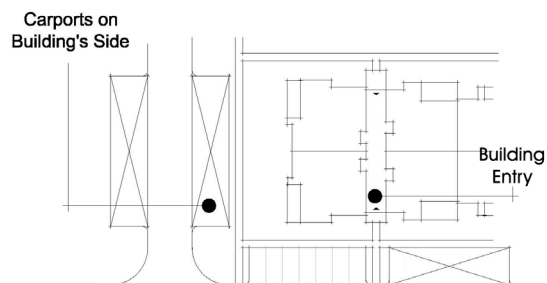

Unobstructed Front Entry

Where detached garages or carports are included, the style, color, and materials of these structures shall be compatible with that of the primary buildings.

Parking Areas

Parking areas should not be a dominant site feature. Where feasible, parking lots should be divided into a series of connected smaller lots. This can be accomplished by incorporating one of the following:

- A landscaped bulb should be used to break up parking lots, with a maximum of 15 contiguous spaces in a row and 10 spaces in a row on average.
- A landscape tree well shall be installed every 5 parking spaces between landscape bulbs.

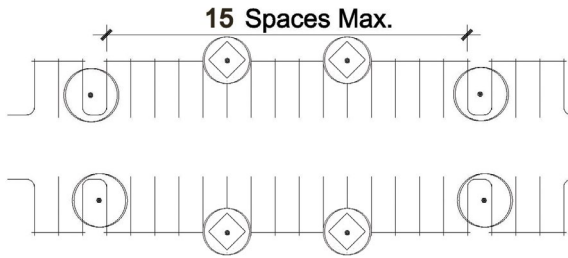

Parking space separation

In addition, parking areas should be treated as “landscape plazas,” with attention to landscape surfaces, softened edges, shade, and pedestrian circulation. This can be accomplished by incorporating at least one of the following:

- Pedestrian walkways should connect public rights-of-way and residential land uses when appropriate.

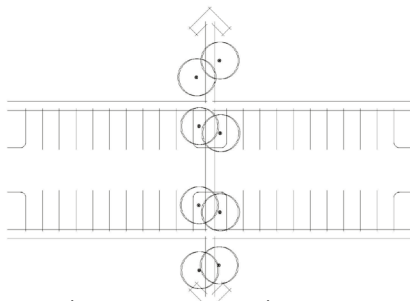

Pedestrian Access in Parking Areas

- Enhanced paving materials, trellises, and landscaping should be used to accentuate the pedestrian circulation system.

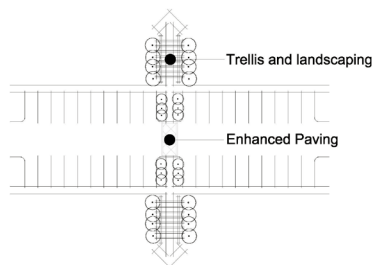

Enhanced Pedestrian Circulation

Refuse & Recyclable Material Storage Areas

The following standards apply to all single family attached residential developments, apartments, parks, and the private recreation center within Serrano Summit:

- Refuse and recyclable materials storage areas shall be enclosed and screened in compliance with the City of Lake Forest Municipal Code.
- Storage areas should be screened from public view through the use of landscaping.
- Where appropriate to the building typology, refuse and recyclable material containers should be integrated into the overall building form to facilitate screening.
- Enclosures shall be finished using materials compatible with the surrounding architecture. Gates shall be solid metal painted to match adjacent buildings.
- The location of storage areas shall be conveniently accessible for trash removal by standard refuse disposal vehicles.
- Storage areas that can be overlooked from above should incorporate roof structures to screen the contents of the enclosure from view. Such roof structures should be designed to allow the doors of the refuse container to fully open.

Loading & Service Access

- Service, loading, storage, and maintenance areas shall be screened from public view where reasonably possible.
- No loading will be permitted from any public street adjacent to the site.
- Service areas must be located and designed so that service vehicles have clear and convenient access and do not prohibit adjacent vehicular or pedestrian circulation or vehicular parking.
- The final locations of loading/service areas will be approved by the City of Lake Forest.

ARCHITECTURAL DESIGN GUIDELINES

7.4

Introduction

Overall Goal

The intent of the following architectural design guidelines is to facilitate the creation of a high-quality, pedestrian-inviting community comprising multiple neighborhoods with a cohesive sense of place. The goal of the guidelines is to ensure a high level of quality in function and visual appearance, in addition to encouraging architectural variety and compatibility.

Simple Home Design

The following are goals for the community and will be enforced by the project master developer:

To meet the high demand for purchasing single family homes, affordability by design is an important consideration for home builders in Serrano Summit. Homes that feature simple structural forms such as building massing and roof forms will allow efficiencies in materials and construction that lower costs for the builder and buyer alike.

Smaller homes are especially likely to benefit from a simple, streamlined architectural design. The “simple house” approach, characterized by stacked massing, simple rooflines and a keen attention to detail, can maximize the buildable square footage of smaller lots. Certain architectural styles are particularly appropriate for the “simple house” approach because of their characteristically simple massing and distinctive details.

Single family detached enclave homes are well suited to simple home design. Architectural embellishments on the side of internal units are often not visible, and thus benefit from the cost savings of a more simplified massing.

The design of higher density single- and multi-family attached buildings must pay careful attention to conveying a sense of human scale. These buildings tend to have larger building masses, but must relate to the neighborhood in a manner that communicates the familiar language of domestic architecture.

All attached dwellings, regardless of architectural style or building typology, should exemplify quality design. Building elements such as form and massing, roof design, materials and color, garage design, detail elements, and functional elements should be consistent with the appropriate architectural styles and should complement those of surrounding buildings and land uses.

Simplified architectural massing also has positive impacts on the reduction of the carbon footprint of the building through more resource-efficient design.

How to Use the Guidelines

The following guidelines have been written to guide builders and architects in creating architecture which is consistent with the envisioned community. While many examples are provided, these are not mandated solutions. Instead, sketches and graphic representations are intended to serve as visual aids in understanding the specific concepts and ideas, while providing flexibility for individual interpretation and creativity.

Included Housing Types

Single Family Detached

Housing types included in this category include front-loaded, and rear-loaded lots, as well as z-lots.

Single Family Enclave

Two examples of single family enclave homes are depicted below.

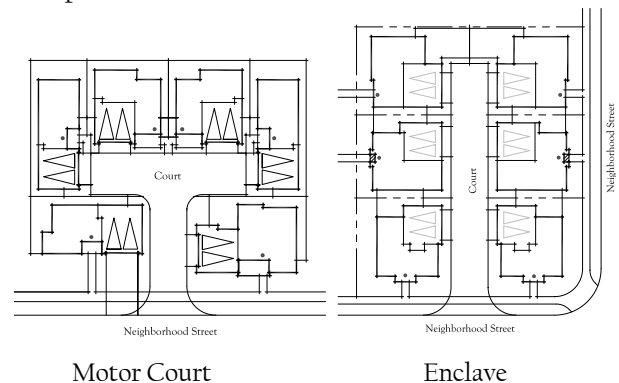

Single Family Attached

Housing types included in this category include rear- and front-loaded duplexes, attached enclave homes, townhomes, and stacked flats.

Multi-Family Attached

This category of housing types consists of rental apartments.

Building Form & Massing

To provide rhythm and balance to the architecture of a dwelling, simple bold elements should be integrated into the design of each building visible from a street or paseo. Several architectural elements should be used to meet this goal:

Vertical and/or Horizontal Stagger

Oftentimes a streetscene with numerous flat unarticulated walls creates an uninviting street presence. Floor plans should feature a mix of vertical and/or horizontal stagger to provide shadow and depth along highly visible edges such as streets and paseos. Within an enclave, homes should be plotted in such a manner as to provide similar relief along paseo edges.

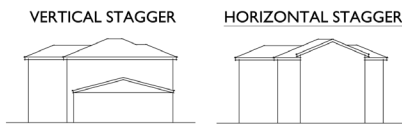

Staggering wall planes limits the bulk of elevations

The form of attached residential buildings should be consistent with the appropriate architectural style and display architectural compatibility. Due to their nature as larger buildings, multi-family building design must be mindful of the relationship to, and impact on, adjacent neighbors. Each neighborhood should include a collection of varied but complementary forms that creates a streetscene that is clear to navigate physically and visually. Buildings should relate to each other both horizontally and vertically.

Maintaining human scale is an important element in attached residential building design. This can be achieved through breaking up one large building shape into multiple forms. The massing of each building should include a distinct base, middle, and top. These layers soften the visual impact of the building on the street, and create a friendly, domestic scale. The base, middle and top of a building can be differentiated using massing, color breaks, and changes in material.

- Visually prominent offsets, both horizontally and vertically, are encouraged in building design to minimize large expanses of uninterrupted wall planes.
- Combinations of two and three-story forms should be used to create variety in setback and overall building form.



Staggering wall planes limits the bulk of elevations

- Massing breaks, such as eroded corners and entry courts, promote visibility and allow block transparency.

One, Two, and Three-Story Forms

Some architectural styles lend themselves to tapered or stepped massing which reduces the bulk of a building. Where appropriate with the architectural style of the building, combinations of one, two and three-story forms to create variety in setback and building form is encouraged.

Building Height

Buildings should incorporate elements that reduce visual height, such as:

- Balconies at building corners to provide negative space.
- Reduced massing along pedestrian-oriented edges is encouraged to create an inviting relationship between buildings and the pedestrian environment.

Forward-Facing Living Spaces

Forward-facing living spaces should be a key criterion for floor plan design and plotting of the dwelling. When compatible with the product type,

it is strongly encouraged that at least 50% of the street elevation should consist of living or entrance area, rather than the garage door face.

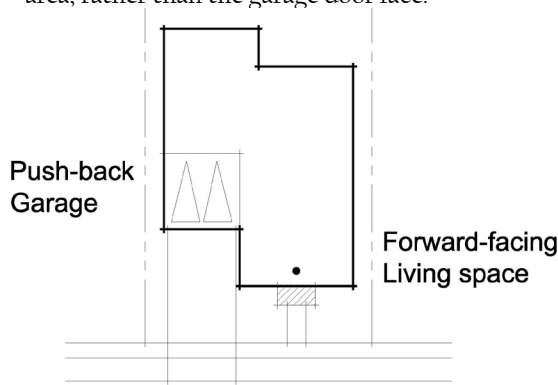

Garages should be positioned to de-emphasize their visual impact on the street

Building Symmetry

Streetscenes possessing visual interest and variety are primary components of Serrano Summit. Where appropriate to the architectural styles either symmetric or asymmetric plan forms are encouraged along street- or paseo-facing homes.

SYMMETRICAL **ASYMMETRICAL**

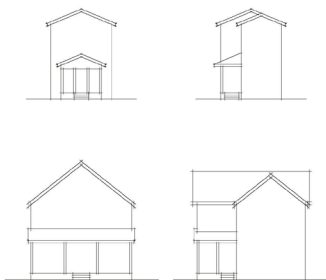

Where appropriate, either symmetric or asymmetric plan forms are encouraged.

Elevation Style

Architectural elements, such as building form, entry, roof, details, materials, and color should be consistent with each building's architectural style.

Architectural styles and elevations must be compatible and appropriate to the building typology (such as linear townhomes and stacked flats).

Single Story Elements

The introduction of single-story elements is encouraged to add variety to the street scene and

help establish pedestrian scale. Where appropriate to the architectural style, single-story elements should include:

- Porch
- Porte-cochere
- Single-story living space
- 4' second-story recess
- Pop-out gable element (enclosed or open)

Roof Design

Homes within Serrano Summit adjacent to paseos and public streets should incorporate techniques that reduce visual height such as variety in roof forms, direction of slopes, and variety in ridgelines and height. These techniques provide diversity and interest to the building form and the neighborhood as a whole.

Roof Form

Variety in roof forms is encouraged throughout Serrano Summit. Appropriate roof forms include, but are not limited to:

- Gable (front and side)
- Cross gable
- Shed
- Hip

Where consistent with the architectural style of the building, the arrangement of different roof forms (including porch roofs, dormers, bays, cross gables, and hips) are encouraged. Some single family detached homes may incorporate roof decks into the overall roof design.

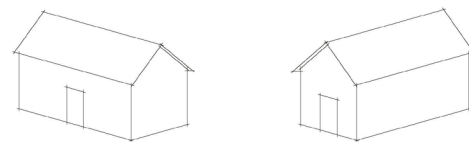

Side Gable

Cross Gable

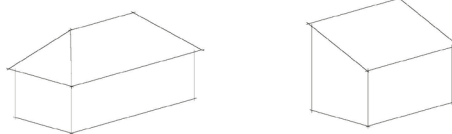

Hip

Shed

Variety in roof form is encouraged.

Roof Pitch

Roof pitch should be consistent with the architectural style of the building, when properly designed in a manner that is architecturally consistent with the building. While 4:12 – 6:12 are generally typical roof slopes, other roof slopes are encouraged where consistent with the architectural style. Flat roofs are discouraged for single family detached homes, but may be permitted for attached and multi-family homes.

Elevation Style

While variety in roof design, materials, and overhangs is encouraged, roof treatments should be compatible with and appropriate to the architectural style of the building.

Fascias

Fascia design should be appropriate to the architectural style of the building. Generally, fascia boards should be made of wood, unless there is an exceptional reason.

Roof Vents

Roof vents should be painted to match the color of the roof material used.

Building Materials

Building color and materials are two of the most dominant visual elements in the architecture of a building. Quality, contrasting materials, including stone, brick, siding, and stucco, can enhance the value of a building.

The application of colors and materials should appropriately match the overall neighborhood design theme. The selection of material palettes should provide variety in color and texture while being harmonious. Also, the use of building materials should be integral to the design of dwelling and architectural style, and should not appear arbitrary, forced, or artificial.

Material Selection

Where appropriate to the architectural style of the building, a variety of materials should be used to

accentuate building form. Such building materials may include:

- Stucco with a finish of light or medium sand or light lace.
- Horizontal, vertical, board and batten, or shingle siding.
- Natural or simulated brick veneer.
- Stone or simulated stone, ledge stone, river rock, country rubble, or fieldstone.
- Contemporary materials, as appropriate to the architectural style of the building.

In prominent locations on buildings such as at main entries and corners of buildings, architectural treatments and materials may be enhanced.

Finish materials should be appropriate in their use and application, durable and of high quality.

Refer to the architectural style sheets provided in the appendices for style-appropriate building materials.

Application of Building Materials

While a variety of building materials is encouraged, in no case shall building materials be chosen arbitrarily. All surface treatments and materials should be designed to appear as an integral part of the design, and not arbitrarily applied.

- Materials should wrap columns and posts in their entirety.
- Material changes should occur at significant architectural elements including roof breaks, half-columns, furred out edges, bay windows, or enhanced trim elements.

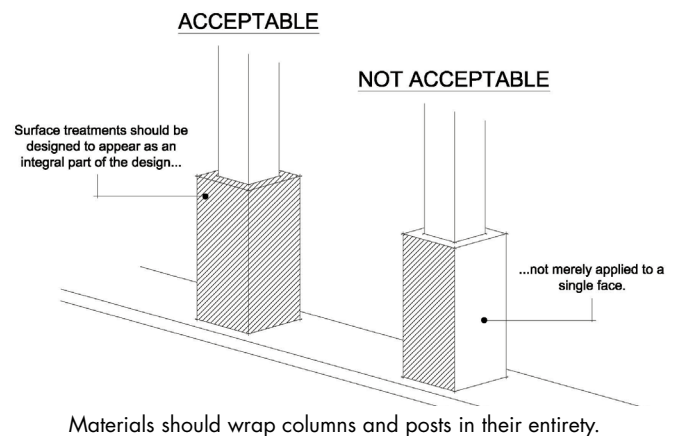

Roof Materials

To provide variety and interest to the neighborhoods in Serrano Summit, a variety of roof materials and colors are encouraged. All roof materials should be compatible with the architectural style of the building and should have a matte finish to minimize glare. Permitted roof materials include:

- S-Tiles, Flat Tiles, and Shakes: Clay or concrete may be used where appropriate to the architectural style of the dwelling.
- Slate or concrete slate: Slate may be used where appropriate to the architectural style of the dwelling.
- Architectural-grade composition
- Metal: Standing seam (as accent roof materials where appropriate to the architectural style)
- Built-up roof

Prohibited Materials

- Wood shingle or shake
- Rolled roofing material

Chimney flue spark arrestors should be disguised with a decorative metal shroud (painted to match the roof) when visible from the street.

Refer to the architectural style sheets provided in the appendices for style-appropriate roof materials.

Building Color

The selection and application of color is a key element to creating visually interesting neighborhoods. To achieve this, a distinct color palette should be developed for each neighborhood.

Color Palette

The color palette should be selected with the design objectives of avoiding monotony, providing a variety of colorful schemes, and promoting visual diversity. Selected colors should be consistent with the architectural style of the building.

Single-family neighborhoods should have a minimum of three color palettes per architectural style.

- Each color palette should contain a minimum of three different colors, not including the roof color.
- Masonry may be substituted for one of the required colors on appropriate styles.

- All primary field colors should be discernibly different from each other.
- Each scheme should have a different accent color.
- Fascia and trim colors may be the same within a scheme.
- Unless appropriate to the architectural theme of Serrano Summit, no two dwelling units with the same color palette should be plotted adjacent to one another.

Refer to the architectural style sheets provided in the appendices for style-appropriate color selection.

Application of Color

The selection of a style-appropriate color palette along with the thoughtful applications and composition of color is an important element in creating a visually attractive building as well as enhancing the value of a neighborhood and the character of the larger community. Requirements for color selection and application are as follows:

- The selection of a building's color palette should be appropriate to its architectural style.
- Color blocking, or the use of multiple colors, should be used only where appropriate to the buildings architectural style.
- Building and material colors should provide depth and interest and be non reflective.
- Selected finish materials should be appropriate in their use and application, durable and of high quality.
- Any field color on a wall plane used at the base of a building should continue down to the foundation.
- Color changes should generally occur at inside corners only.
- Accent colors should be used primarily on ornamental elements, railings, shutters, front doors, and similar architectural features.
- Masonry colors should be selected to compliment the architectural style and overall color palette of the building. Grout colors should harmonize and blend, rather than contrast with the colors of the particular masonry materials.
- Exposed woodwork, beams, posts, railings, etc. should be colored to match a buildings fascia
- Trim colors for window trim and recesses should be selected to be discernable for the building color.
- Exposed gutters and downspouts should be colored to match or compliment the surface to

which they are attached, or painted to match the buildings color palette.

- All bare metallic surfaces (vents, pipes, gutters – excluding copper gutters, etc.) must be painted or covered from view in a manner harmonious with the general exterior architecture treatment of the building. All flashing and sheet metal must be colored to match the material to which it is attached.
- Colors applied to fascia, garage door, window frame and mullions should be selected to complement the architectural style and color palette of the building.

Garage Design

The relationship between the residential building and the street is an important element of neighborhood character for Serrano Summit. On all streetscenes, the amount of building allocated to living space (living rooms, dining rooms, entries, and other non-garage spaces) shall be maximized. Primary forward-facing living spaces should be a key element of most floor plan designs along with plotting of the dwelling to help activate the street and promote walkable neighborhoods.

Garage Placement Options for Single Family Detached Homes

Garages for single family detached homes should be staggered with respect to orientation and location on the lot. Some garages may be pushed back from the house and others rotated to a turn-in fashion so the visually interesting features of the homes dominate the streetscene. Paired driveways and garages are permitted within all residential areas in Serrano Summit.

Single family detached front loaded (Table 10-1) neighborhoods should feature a minimum of three of the following garage placement options recessed, rear-loaded, or split garage. To maintain a diverse and non-garage dominated streetscene, no more than one floor plan per neighborhood may feature a flush/garage forward plan.

Recessed

Recessed garages are located behind the front elevation/ living space.

- Shallow Recess: Garage is set back a minimum 5' from front elevation or living space

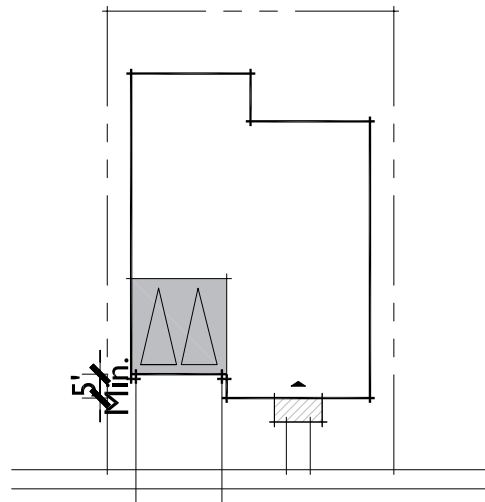

Shallow recess garage

- Medium Recess: Garage is set back a minimum 8' from front elevation or living space

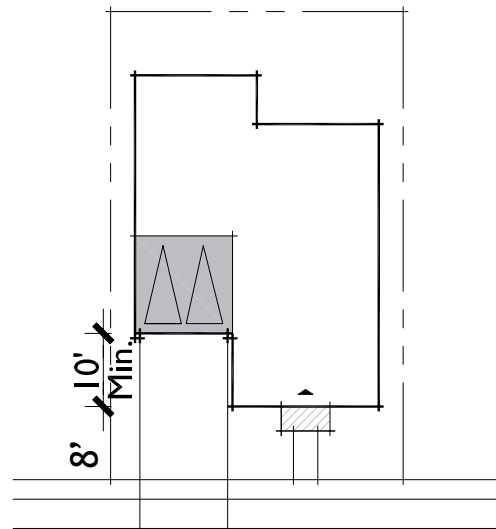

Medium recess garage

Rear Loaded

Rear loaded garages are accessed from a rear or side alley. The garage door face shall be recessed 6" or include fur-outs 6" forward of the garage plane (see image on following page).

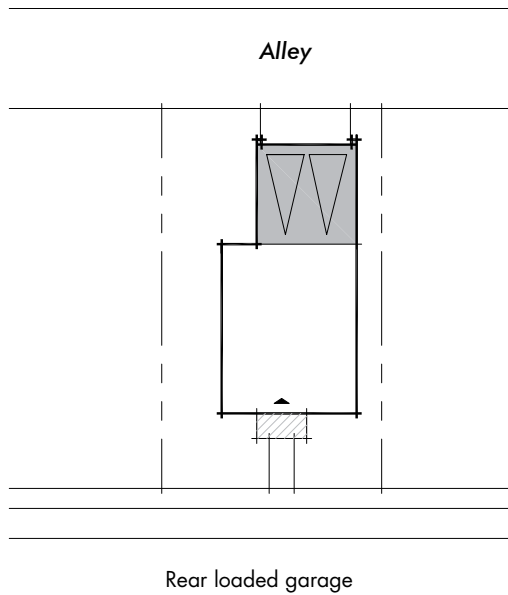

Corner Condition

This garage placement allows the option of entering from the side street, thereby eliminating the garage and driveway from the front face of the house. Side-street entry garages can be attached or detached.

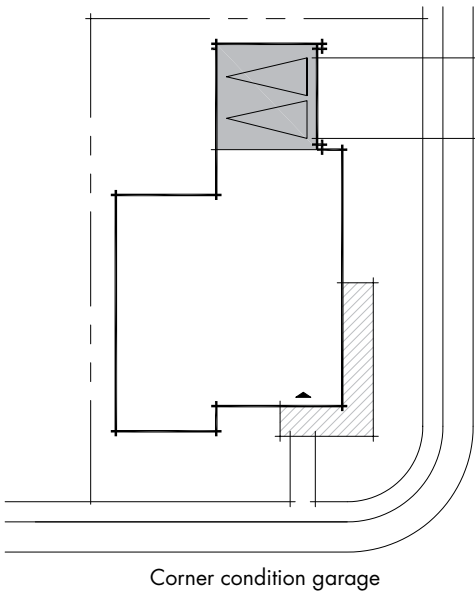

Turn-In

Turn-in garages greatly reduce the impact of garage door faces on the streetscape. These garage placements can be located at the front, side or rear of a plan. To provide adequate back-up space, side entry garages are limited to lots 53' or wider.

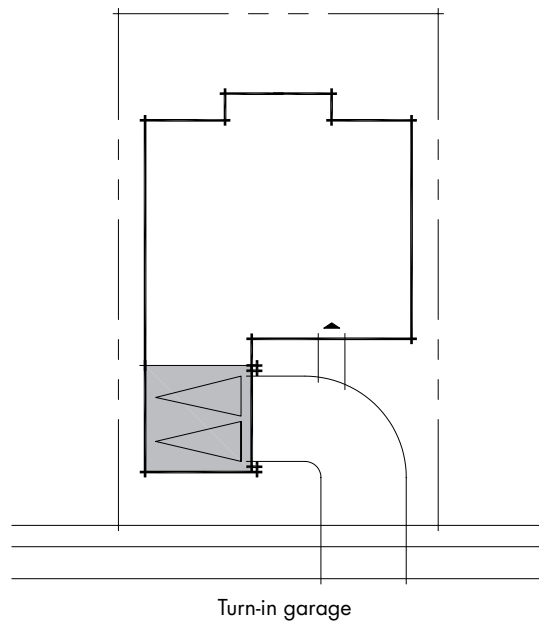

Flush / Forward Garage

This garage placement is located flush or forward of the home's front facade. Extra attention and treatments must be applied when using this garage location. For example, a decorative garden fence, low wall with gates, trellis, porte-cochere, or additional landscaping. Garage door faces should be recessed a minimum of 12 inches or have a fur-out of at least 12 inches projecting forward of the garage door.

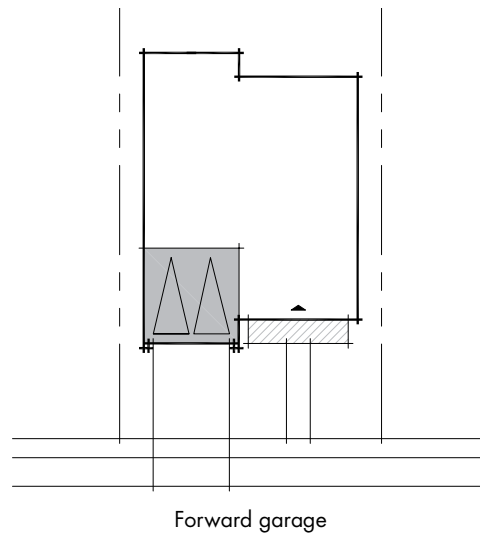

Detached

Garages detached from the primary residence are generally located toward the rear of the lot. Similar architectural details as designed on the primary residence should be applied to the detached garage.

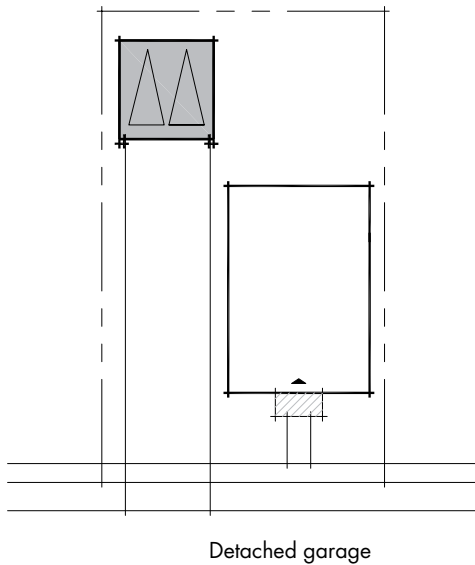

Tandem

Tandem garages are long, rectangular garages capable of accommodating two vehicles, end to end in the width of a standard one car garage. Tandem garages allow a narrower garage frontage and the ability to park automobiles in tandem. This orientation lessens the impact of the garage doors on the streetscene by creating the appearance of a single car garage. Tandem garages should be recessed a minimum of 12 inches or have a fur-out of at least 12 inches projecting forward of the garage door.

Current economic trends are favoring smaller dwelling unit sizes. Tandem parking allows for more flexibility and innovation in design and works well with higher density products. Higher density products are generally more affordable, which is what consumers are searching for in today’s housing market.

The provision of a tandem garage, rather than the traditional two-door garage, provides an opportunity for housing complexes to fit more dwellings per acre without reducing parking requirements or sacrificing neighborhood character.

Tandem parking is a parking design tool, not a tool for reducing parking requirements. The most efficient operation of tandem parking is when both parking spaces are contained within an enclosed garage owned by a single owner.

In addition, tandem parking visually de-emphasizes the garage by making a two-car garage have the appearance of a one-car garage. This makes for a more appealing streetscene with fewer and smaller garage doors.

Use of tandem parking shall be evaluated on a case-by-case basis prior to the B Map process and future site development permit or use permit process. Requests for tandem parking must include justification that addresses how a tandem garage configuration will comply with parking in the same manner as a side-by-side garage.

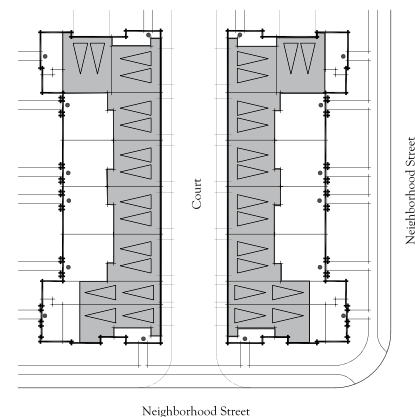

Residential product with select tandem garages

Offset Garages

Offset garages have garage doors which are offset from one another. The offset creates depth and shadow, articulation, and interest to the front façade of the dwelling. The garage door face of forward or flush garages should be recessed a minimum of 12 inches or have a fur-out of at least 12 inches projecting forward of the garage door.

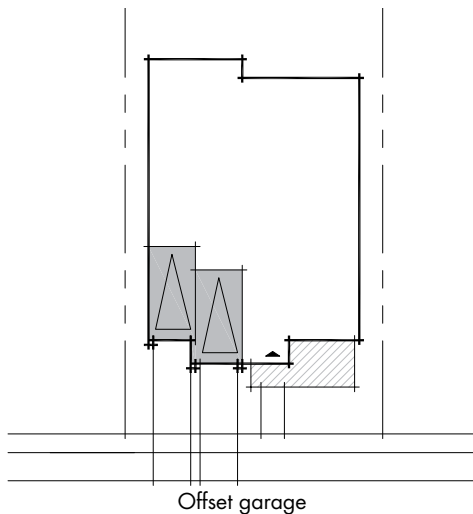

Split Garages

Split garages have garage doors separated from one another. The split creates articulation, and interest to the rear façade of the dwelling. Garage door faces should be recessed a minimum of 12 inches or have a fur-out of at least 12 inches projecting forward of the garage door.

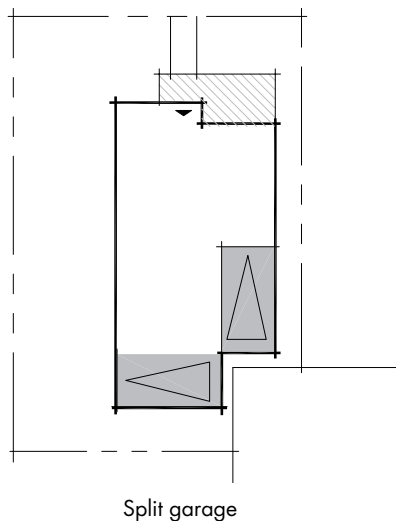

Standard Garage Doors

Street-facing garage doors shall be recessed a minimum of 6 inches or be surrounded with 6-inch minimum fur-outs. Garages loaded off a lane or court street may have the garage door face offset a minimum of 6 inches or be surrounded with six-inch minimum fur-outs. No additional offset or fur-out is required on recessed or turn-in garages.

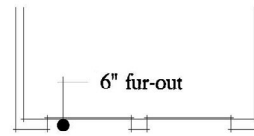

Street-facing Garage

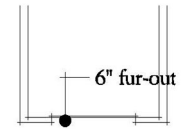

Alley/Court-facing Garage

Standard garage recesses

Garage doors shall be compatible with the architectural style of the residence. Decorative window lites, when used, should be appropriate to the architecture of the building.

Garages for Multi-Family Housing

- Provide one required covered parking space in garage or carport for each unit. See Section 10, Development Regulations, for parking requirements.
- Use of tandem parking shall be evaluated on a case-by-case basis during the B Map process.

Outdoor Living Space

The homes of Serrano Summit should create an inviting pedestrian environment. The incorporation of a usable outdoor living space into the design of each dwelling provides residents an opportunity to engage in the outdoor environment.

Covered Porches and Entries

Porches are outdoor covered spaces usually located at the front entry of the residence. They not only help to provide a pedestrian scale element to the building massing, but also allow an area for residents to enjoy the outdoor climate while conversing with neighbors.

- Integral to the Design: Where porches are provided, they should be designed as an integral element of the building with details, eaves, supports, and railings in keeping with the architectural style and other elements of the building's design.
- Covered Elements: Porches shall be fully covered in one of the following ways:
 - ~ Roof element matching the residence
 - ~ Trellis structure
 - ~ Second-story balcony or overhang
- Columns: Columns used in conjunction with porches should convey a sense of strength and support.

- **Minimum Size:** Covered porches shall be a minimum of 6' deep (posts or columns can be included in this minimum area).
- **Wrap Porches:** On corner lots or lots adjacent to open areas, porches that wrap the corner of the building are encouraged.
- **Covered entries,** if provided, shall have a depth of at least three feet (3') to provide shelter from the elements

Balconies

A balcony is a projecting platform on the exterior wall of a building that is usually enclosed by a railing or balustrade. Balconies provide visual relief to the building mass and add human scale. Balconies are either cantilevered outward from the exterior wall or supported from below by columns or brackets, depending on the architectural style of the building.

- **Integral to the Design:** Where balconies are provided, they should be designed as an integral element of the building with details, eaves, supports, and railings in keeping with the architectural style.
- **Location:** Balconies may be covered or open (covered or trellised balconies are preferred for single-family attached and multi-family attached homes). They can be either recessed into the mass of the building or designed as a projecting element and can be located on any side of the dwelling.
- **Minimum Size:** In order to be functional, balconies should be a minimum of four feet (4') in depth.
- **Decorative Balconies:** The use of architectural enhancements such as decorative balconies is encouraged where appropriate to the architectural style of the building. No minimum depth is required for decorative balconies.
- **Columns:** Columns used in conjunction with balconies should convey a sense of strength and support.
- **Scuppers or internal drains** are required on all balconies for drainage.

Courtyards

A courtyard is a ground level outdoor space, partially or fully enclosed on all four sides by the building or courtyard walls. The design of a courtyard is integral to the floor plan as it provides a transition from the public street to the private entrance of the home.

- **Integral to the Design:** Where courtyards are provided, they should be designed as an integral element of the building; courtyard walls should be finished to match the building. Stone, ceramic tiles, steps, recesses, cut-outs, or wrought iron accents are encouraged.
- **Location:** Courtyards may be located on the front, side, or rear of the dwelling, or can be internal to the floor plan.

Architectural Detailing

In keeping with creating a quality development, architectural detailing is a key element to home design in Serrano Summit. The quality and appropriate use of detail elements is important and should be genuine to the architectural style of the building. Architectural detail elements may include:

- **Railing:** Wood or synthetic wood product, wrought iron, or tubular steel railing;
- **Brackets and Fascia:** Wood, synthetic wood product, or stucco outlookers, brackets, fascia, dentils, and corbels;
- **Trim, Headers, and Sills:** Wood, synthetic wood product, foam, or stucco trim surrounds, headers, and sills;
- **Decorative Ceramic or Clay:** Decorative ceramic or clay tiles and pipe vents;
- **Grille Work:** Decorative wrought iron grille work;
- **Gable-end Detailing:** Decorative wood, synthetic wood, or foam gable-end detailing;
- **Shutters:** Wood or manufactured shutters – Bermuda shutters, plank shutters, louvered shutters; and
- **Style Specific Elements:** Other architectural style specific details.

Buildings should activate the street, utilizing elements such as canopies and awnings, stoops, plazas, and enhanced entries with porches, trellises or courtyards, where appropriate to building typology and architectural style.

Entries

In order to create a pedestrian-friendly neighborhood, each home in Serrano Summit shall be designed with an enhanced front entry, where appropriate. The entry can be articulated in a variety of forms, but should remain consistent to the architectural style of the dwelling. Potential enhancements may include, but are not limited to:

- Porches;
- Covered entry;
- Courtyards;
- Projecting roof elements; and
- Porticos.

Windows

Generally, the location of windows is determined by the practical considerations of room layout, views, and privacy. Because windows play an important role in the exterior architectural character of the home, special emphasis should be given to the way windows are used for design effect.

- **Trim Surrounds:** All windows on the front, side, and rear elevations that are visible from parks, open space areas, and public rights-of-way should feature trim surrounds, headers, or sills. Trim should be proportionate to the size of the window, with a minimum of one inch (1"). The style of trim should be consistent with the architectural style of the building.
- **Window Style:** The style and shape of windows should be consistent with the architectural style of the building. Where appropriate to style and window form, use of multi-paned windows is encouraged.
- **Headers and Sills:** The design of header, sill and trim elements must be consistent with the architectural style of the residence.
- **Window Colors:** Vinyl, extruded wood and clad-wood frame windows should be appropriately colored to match or complement the building or trim colors. Aluminum frames are not permitted.
- **Glazing:** Glazing may be either clear or tinted. Reflective glass is not permitted.
- The use of mirrored or highly reflective glass is not permitted, unless proved to be energy efficient.
- Windows on the second and third floor of a building should be treated with detailing of similar quality as those on the ground floor on all sides where visible from public view.

Awnings

Awnings, when provided, should be designed as an integral part of the architecture and should be consistent with the architectural style of the building.

Functional Elements

Mechanical Equipment & Meters

Special care should be taken that mechanical equipment does not detract from the architecture as follows:

- Mechanical equipment such as air conditioners, heaters, and evaporative coolers may not be mounted on any sloped roof.
- When mounted on flat roofs of attached homes, mechanical equipment should be completely screened by parapet walls at least as tall as the equipment screened.
- Ground mounted air conditioning units visible to public view must be screened by walls or landscaping at least six inches (6") higher than the unit and located away from pedestrian paths and project amenities, except when used in courts and lanes with limited or no screening.
- Mechanical devices such as exhaust fans, vents and pipes should be painted to match adjacent roof surfaces.
- Natural gas and electrical meters for single-family detached homes should be screened to be integral with the architecture of the home.
- Natural gas meters for attached homes should be grouped and screened behind walls or landscaping.
- Electrical meters for attached homes should be ganged and located behind doors.
- Screen walls and electrical enclosures should be designed integral to the building architecture.
- Solar panels shall be integrated into the roof design, parallel with the roof slope. Frames shall be colored to match roof colors. Any support equipment shall be enclosed and screened from view.
- Residential transformers shall be placed and screened where permitted by the utility companies.

Gutters & Downspouts

Exposed gutters and downspouts shall be colored to match or complement the surface to which they are attached, or be colored to match accent colors of the building. However, gutters and downspouts are encouraged to be located within the walls of the buildings.

Chimneys

Chimneys are not required but if used shall be simple in design and compatible with the architecture of the building. The following features are appropriate:

- Tile caps, brick or tile banding.
- Elaborated chimney tops for Spanish Hacienda style.
- Decorative metal caps that match trim colors.

Exterior Lighting

The level of on-site lighting, as well as lighting fixtures, shall comply with any and all applicable requirements of the City of Lake Forest Code. Energy conservation shall be emphasized when specifying any lighting system.

The style, color, and finish of exterior lighting fixtures shall be consistent with the architectural style of the building. The angle and intensity of lighting should

be strategically planned for mobility and safety at night and should not be used in excess of its purpose.

Exterior Stairs

Exterior stairs for attached homes should be designed as an integral part of the architecture.

- Stair guardrail design should be consistent with the architectural style of the building.

Accessory Structures

To ensure cohesive design, detached garages and other similar accessory structures should be compatible in design, materials, and color with the primary building. Such structures should also visually relate to the main building through the use of courtyards, garden walls, or other landscape elements.

GREEN BUILDER PROGRAM

7.5

The following are guidelines and programs for the Serrano Summit community and will be enforced by the project master developer:

Introduction

As part of the project's objective to create an energy efficient community of choice, builders within Serrano Summit shall incorporate green development techniques. This can be achieved through energy conservation, reduction of non-renewable resources, and California-appropriate landscape practices.

Such practices include reducing the impact of the built environment through energy reduction as well as the reduction and reuse of non-renewable resources. While a third party program is not required for residential development within Serrano Summit, builders are encouraged to participate in voluntary programs such as the California Green Builder (CGB), Energy Star, NAHB's Model Green Home Building Guidelines, Build It Green's Green Point Rated Program, and the US Green Builder Council's Leadership in Energy and Environmental Design (LEED).

California Green Builder

The Building Industry Institute has established minimum standards for California Green Builder eligibility. These guidelines set goals for significant improvements in Energy Efficiency, Indoor Air Quality and Comfort, On-site Waste Recycling, and Water and Wood Conservation. CGB offers a certification for homes which meet the standards. For more information about CGB, visit www.cagreenbuilder.org.

Energy Star

Energy Star qualified homes are independently verified to meet strict guidelines for energy efficiency set by the U.S. Environmental Protection Agency (EPA). Typical features include efficiency in home envelope, air distribution, equipment, lighting, and appliances. For more information about Energy Star, visit www.energystar.gov

NAHB's Model Green Home Building Guidelines

NAHB's voluntary Model Green Home Building Guidelines are designed for individual builders interested in green building practices. The Guidelines contain six primary sections: Lot Preparation and Design, Resource Efficiency, Energy Efficiency, Water Efficiency/Conservation, Occupancy Comfort and Indoor Environmental Quality, and Operation/Maintenance/Education. For more information on the NAHB's Model Green Home Building Guidelines, visit www.nahb.org

Green Point Rated

GreenPoint Rated is a program of Build It Green, a professional non-profit membership organization whose mission is to promote healthy, energy- and resource-efficient new home construction in California. A GreenPoint Rated home is graded on five categories: Energy Efficiency, Resource Conservation, Indoor Air Quality, Water Conservation, and Community. For more information on the Green Point Rating program, visit www.builditgreen.org.

LEED

The LEED program categorizes performance in five areas: Site Development, Water Savings, Energy Efficiency, Materials Selection, and Indoor Environmental Quality. Sub-programs include LEED-ND (neighborhood development), LEED-NC (new construction) and LEED-H (homes). The LEED program offers four levels of certification: certified, silver, gold, and platinum. For more information on the LEED certification process, visit www.usgbc.org

Energy Conservation through Building Design

At a minimum, all buildings (except for ancillary buildings) shall either exceed the 2007 California Energy Code – Title 24, Part 6 in energy efficient design by at least 15% or comply with the California Green Building Standards Code, which was adopted in 2008. In order to meet this standard, elements of energy efficient design may include, but are not limited to:

1. High efficiency lighting:



- ~ The installation of high efficiency lighting, such as CFLs (compact fluorescent lighting), greatly reduces energy consumption.
- 2. Low energy cooling system, such as engineered HVAC systems with tight HVAC Ducts
 - ~ Low energy HVAC systems that are installed with tight ducts increase the efficiency in heating and cooling the home.
- 3. Improved drywall, insulation, and sealing installation
 - ~ Proper installation helps to maintain the desired temperature inside the home, lessening the dependence on mechanical heating and cooling systems.
- 4. Cool roofs
 - ~ A cool roof reflects and emits the sun's heat back to the sky instead of transferring it to the building below. "Coolness" is measured by two properties, solar reflectance and thermal emittance. The higher the value, the "cooler" the roof. By limiting heat penetration into the attic and living areas of the home, dependence on mechanical cooling systems can be reduced.
- 5. Dual-glazed LoE2 windows with high-efficiency glazing (SHGC and U-value < 0.40)
 - ~ Dual-glazed Lo E2 windows limit heat and coldness penetration, therefore reducing the need for mechanical heating and cooling.

In addition, builders within the community are encouraged to incorporate other energy efficient design elements. Such elements may include, but are not limited to:

1. On-site renewable energy systems (PV solar panels and solar water heaters)
 - ~ Roof-integrated photovoltaic cells can be used to offset energy consumption.
2. Energy Star appliances
 - ~ Energy Star appliances use a minimal amount of energy and lessen the home's overall energy consumption.
3. Natural Ventilation – Window Placement and Home Orientation
 - ~ Proper window placement and home orientation allows for natural ventilation, thus lessening the dependence on mechanical cooling systems.
4. Architectural shade elements
 - ~ Architectural shade elements (such as overhangs and awnings) protect excess sun from entering the home, keeping the house cool during the hot summer months.

Reduction of Non-Renewable Resources

The reduction of non-renewable resources is an important aspect of green design. Such reduction practices include, but are not limited to:

1. Utilization of Environmentally Preferable Building Materials
 - ~ Environmentally preferable building materials such as non-virgin, renewable, and recyclable materials aid in the reduction of non-renewable resources.
2. Construction Waste Recycling Program
 - ~ On-site recycling and/or donation of scrap materials to local charitable organizations greatly reduce construction waste.
3. Low-flow Water Fixtures
 - ~ Low-flow water fixtures limit the amount of water used on a home basis.

California-Appropriate Landscape Practices

Elements of California-appropriate landscape practices include, but are not limited, to California-friendly landscape, water-conserving irrigation practices, and energy conservation. These practices include but are not limited to:

Water-Wise and California-Friendly Landscape

- California-appropriate vegetation that reduces the consumption of water shall be incorporated into Serrano Summit's landscape. See Landscape Guidelines for the Master Plant Palette.
- Planting design (species, quantity, size and spacing) shall achieve 70% landscape area coverage within two (2) growing seasons from installation.
- Plants with high water demand are encouraged to be located in shade areas, in small highly visible areas, or where more runoff naturally occurs.
- The use of turf grass is encouraged in active use areas only. Groundcovers and drought-tolerant grasses that require less water are encouraged in non-active areas.
- No more than 50 percent of homeowner's property outside the building envelope shall be to be planted with turf; this reduces water usage by requiring a greater amount of private landscape to utilize a California friendly landscape palette.

- No more than 25 percent of homeowner's front yard landscape shall be to be planted with turf.
- Plants of similar water requirements shall be grouped to allow more effective use of irrigation.
- The ground plane shall be covered with a minimum 2" layer of decorative material to improve water-holding capabilities of soil through reduced evaporation and compaction.
- The use of decorative gravel is encouraged as a design element to offer a variety of colors and texture within landscape areas. The size of the material is to be suitable so as to remain in place once it has been installed.
- The use of mulch can also be used in landscape areas. The size of the material is to be suitable so as to remain in place once it has been installed.
- Install a 12" minimum border of decomposed granite/decorative gravel along back of curb within the parkway to minimize irrigation overspray into the gutters.
- A demonstration garden incorporated into park space as a public outreach effort to inform and educate the community is encouraged.
- Turf areas shall be sized and shaped to optimize irrigation efficiency. Turf type and location shall be selected in the same manner as other plantings. Turf shall not be treated as a fill-in matter but rather as a planned element of the landscape. All turf areas shall be on separate irrigation zones. The following conditions shall apply:
 - a. *No turf may be used on slopes greater than 4:1.*
 - b. *If turf is used in isolated areas (i.e. driveway strips) subsurface irrigation or micro-spray heads shall be required to avoid over-spray.*
 - c. *Turf areas less than eight (8) feet wide on the shortest side shall be irrigated with subsurface irrigation or micro spray heads.*
 - d. *Irregular shapes that cannot be irrigated efficiently shall be avoided.*
- Turf shall not be planted within landscaped parkways and/or median.
- Artificial turf shall be permitted within all areas of Serrano Summit except for Planning Areas 17 and 18.

Water-Conserving Irrigation Practices

- Utilizing point-irrigation systems is encouraged to allocate more efficient delivery of water to root systems and minimize run-off.
- Utilizing a weather-based master irrigation controller system that employs the use of current

satellite weather data and rain shut-off device to ensure that the irrigation schedule is based upon actual "real time" plant needs. This allows for a greater level of control within the irrigation system and minimizes potential water waste.

- Using reclaimed water in large, public open spaces is encouraged.
- Design irrigation system based upon solar exposure. Irrigation heads should be grouped in South/West and North/East exposures. This ensures that heads with similar sunny exposure will be grouped together on the same valve and heads with similar shaded exposure will be grouped together.
- The use of overhead spray heads is discouraged in small non-turf applications. The use of point irrigation or sub-surface irrigation dripline root zone irrigation system negates overspray and reduces water waste.
- Turf areas shall be irrigated with equipment that has a precipitation rate of one (1) inch or less per hour as specified by the manufacturer. Stream rotator heads are preferred; use of standard spray heads shall be avoided.

Energy Conservation Through Landscape Design

- Community and residential area landscapes are encouraged to be designed to assist with energy conservation, including planting deciduous trees next to buildings and along streets to reduce ambient temperature, reduce heat gain, allow for cool natural ventilation, and provide a more pleasant pedestrian environment.
- Deciduous trees and vines are encouraged to be planted in front of south-facing walls and windows to further cool buildings by intercepting sunlight during summer months, yet allow direct sunlight during the winter.
- Green screens (metal lattices planted with vines and/or climbing flowers) are encouraged to shade south and west-facing walls to reduce interior heat gain and beautify buildings.
- Trees with appropriate heights and spreads are encouraged to provide ample shade in the summer months for outdoor spaces such as patios and plazas, pedestrian walkways, roadways and parking lots. Structures such as trellises and porticoes should also be incorporated into the building/landscape edge, especially on south and west-facing exposures, to provide shade in the summer and allow solar penetration when the sun is at a low angle in the winter.

- Landscape buffers, screens and windrows are encouraged to be located so they facilitate cooling by prevailing breezes in summer months.
- Using trees or shrubs to shade the air-conditioning units can help increase its efficiency and reduce the temperature inside the home by several degrees.
- As technology develops, employing an appropriate means of capturing, storing and reusing on-site waste run-off water within an individual residential property is encouraged.

Sustainable Design Features

All subsequent development shall consider, but not be limited to, inclusion of the following list of potential design features. These features shall be incorporated into the project design to ensure consistency with adopted statewide plans and programs. The project developer shall demonstrate the incorporation of project design features prior to the issuance of building or occupancy permits, as noted below.

Transportation, if applicable:

- Provide pedestrian connections to the off-site circulation network (Prior to issuance of a building permit).
- Implement a trip reduction program, for which all employees shall be eligible to participate (Prior to issuance of an occupancy permit).
- Provide a ride sharing program, for which all employees shall be eligible to participate (Prior to issuance of an occupancy permit).

Energy Efficiency

- Design buildings to be energy efficient, 15 percent above Title 24 requirements (Prior to issuance of a building permit).
- Install cool pavements.
- The landscape plan shall utilize strategically placed trees that shall shade building walls, particularly those containing the most windows (Prior to issuance of a building permit).
- Install high efficiency lighting, and energy efficient heating and cooling systems (Prior to issuance of a building permit).
- Reduce unnecessary outdoor lighting (Prior to issuance of a building permit).

Water Conservation and Efficiency

- Install water-efficient irrigation systems (Prior to issuance of a building permit).
- Comply with the landscape sustainability measures in the Sustainability Development Regulations of the Serrano Summit Area Plan (Prior to issuance of a building permit).
- Install low-flow faucets and toilets (Prior to issuance of a building permit).

Solid Waste

- Reuse and recycle construction and demolition waste (including, but not limited to, soil, vegetation, concrete, lumber, metal, and cardboard) (Prior to issuance of a building permit).
- Provide interior and exterior storage areas for recyclables and adequate recycling containers located in public areas (Prior to building permit issuance).

CIVIC CENTER DESIGN GUIDELINES

Section 8.0

November 2016



GENERAL GUIDELINES FOR THE CIVIC CENTER

8.1

Introduction

The Civic Center Design Guidelines within the Serrano Summit Area Plan outline the site planning, structure, and design of the proposed Lake Forest Civic Center. Architectural details will be used to enhance the buildings, particularly on elevations that are highly visible from the public realm, giving them more aesthetically pleasing façades, and integrating the structures with the overall community theme. Landscaping should be used to highlight the positive features of the building forms and site, while screening views of the negative features, where feasible.

Photographs in this section are provided for conceptual use only, and should not be used as a literal guide for architectural design.

Restricted Uses

The Public Facility Overlay allows Planning Area 13 to be used for Civic Center purposes, including those municipal services commonly provided by general law cities at city hall and civic center complexes, consistent with the provisions of Section 10.7 in this Area Plan for the “Public Facility Overlay.” The following land uses shall not be included in any plans for the Civic Center site (“restricted uses”):

- Animal shelter.
- Dog park.
- Skate park.
- Roller hockey facility.
- A maintenance yard whose primary purpose is maintenance and repair of vehicles and machinery.
- A fire station with the primary function of providing firefighting and paramedic services.
- A permanent jail facility, excluding holding or similar cells as part of a sub-station of the Orange County Sheriff or other law enforcement agency.
- A parking structure exceeding the greater of 3 stories or 36 feet in height.
- Storage or overnight parking of trash trucks.
- Third party retail uses requiring permits, but excluding vending machines.

- High Hazard Group H occupancy as defined and described in Section 307 of the 2007 California Building Code.
- Any use that violates the City’s noise ordinance, contained in Section 11.16 of the Lake Forest Municipal Code.
- Any use, purpose or activity not associated with those uses, purposes, or activities normally associated with a civic center, including, but not limited to, city governance, community activities and gatherings, special community events, and related public uses and activities.

Design Objectives

The design objective of this section is to concentrate architectural detailing toward building areas that are highly visible to the public, while promoting an environment of common courtyards, public plazas, and open space areas.

The intent of these design objectives is not to reduce the total amount of architectural detail and landscaping used, but to orient such enhancements in highly visible areas within the public realm.

Site Design

The following concepts are intended to facilitate architectural quality and compatibility between a variety of buildings and uses within the Civic Center site, as well as with surrounding uses within Serrano Summit.

Building Orientation

- Building Orientation should facilitate the intended function of the Civic Center area.
- Both the main vehicular and pedestrian entries to Civic Center areas from the street should be enhanced with textured pavement, landscaping and accent trees, and appropriate lighting.

Site Preparation

- The Civic Center site shall be delivered by the property owner to the City uncertified as to compaction (City will recertify the site after taking title).

- The Civic Center site shall contain a nine acre rough graded pad with a maximum 2% slope (the 2% maximum slope criteria shall not apply to the slope internal to the pad and such slope shall not be included in the net pad area calculations), street access to the perimeter of the site, wet and dry utilities to the perimeter of the site (including an off-site sewer line, if necessary, to provide sewer service for all of the nine-acre property at all pad elevations, and connection to project area storm drainage system).
- The exact boundary of the site will be determined by the Grading Plan and the City's Site Plan, and both parties acknowledge that the actual gross acreage offered for dedication to the City will exceed nine acres, will run to certain property line and right-of-way boundaries, and will include some slope banks adjacent to the Civic Center pad. Acreage calculated with the formula in this paragraph shall be referred to as "Net Acres."

Visible Edges

- Highly visible Civic Center building edges around the Civic Center area should be designed to provide a pleasant aesthetic, complementing the style of surrounding buildings.

Mechanical & Functional Equipment

- Outdoor storage shall not exceed the height of surrounding walls.
- Ground mounted equipment, such as transformers and heating units, if otherwise visible to the public, should be screened with walls and/or landscaping.
- No utility appurtenances shall be allowed directly within a pedestrian area.

General Guidelines for Buildings

Building forms should exhibit a discernible base, body, roof line and entry with colors and materials chosen in support of these key elements.

Major architectural elements, such as building mass, roof type, height, entrances, openings, arcades and other similar features should complement and harmonize the architectural style and proportion of the buildings.

Massing & Articulation

Building articulation shall be used to break up a single, dominant building form.

- Expansive, un-articulated surfaces should be avoided when visible from a public street. The use of varying textures is encouraged.
- Building height may be reduced through vertical massing breaks that complement the style of the building.
- Returns must terminate at a logical point and must be finished and treated on all exposed sides.
- Articulation elements, such as insets and pop-outs, and horizontal and vertical elements may be used to give visual interest to buildings.
- Massing elements and building projections should relate to the proportions of the building.
- Where used, tower elements shall relate to the massing of the building and architectural style proposed. Tower elements include architectural components that are higher than the adjacent building's parapet or roof.
- Roof forms should be simple and complement the architectural style and internal organization and function of buildings and surrounding residential.
- Buildings shall include at least one minor and one major focal point, utilizing changes in building forms, materials, or colors. Focal points may double as primary entry articulation.

Building Entries

- Entries should be designed as an integral part of the building form.
- Primary building entries should be easily identifiable and emphasized through building massing, architectural elements, and material use.

Architectural Detailing

- Careful detailing, such as expansion joints, reveals, cornices, eaves, parapets, and window treatment, should be used to provide an attractive elevation to all façades visible from public streets.
- A variety of colors and materials should be used throughout the building's elevations not to exceed four (4) complementary colors.

Material & Color Use

- Materials and colors should be used logically, with darker colors and/or “heavier” materials used on the base, “supporting” lighter colors and materials above it.
- Colors chosen should not be used to accentuate building form or call attention to building features.
- Subtle accent colors that compliment the building’s color palette may be used to identify special areas or entries.
- Materials should wrap architectural elements in their entirety. Changes in materials along a building elevation should occur at inside corners only.
- Materials used should be durable and long lasting.

Mechanical & Functional Equipment

- Mechanical equipment visible from the public realm should be located as to be screened by the building’s architecture or screens, where possible.
- Ground mounted equipment, such as transformers and heating/air conditioning units, shall be screened with walls and/or landscaping and located away from all pedestrian areas.
- Outdoor storage shall not exceed the height of surrounding walls.
- Major utility lines, such as gas, telephone, and electrical (34.5kV or less) shall be placed underground when feasible and as approved by the local utility company.
- Trash bins to be screened from any public views by fencing, walls and/or landscaping

Civic Center Buildings

The following design guidelines provide guidance and direction for the design of specific building uses on the Civic Center site, and cover site design, construction materials, appurtenances, and site elements. They do not, however, provide direction for any particular architectural style.

Civic Center and governmental buildings should be designed and constructed to be of a high quality, with form, massing, and style that complements that of its surroundings.

Location

Buildings may be oriented around an open space such as a central courtyard or plaza.

Pedestrian connections between office buildings and the uses that they serve shall be convenient, direct, and well-lit for the user.

Building entries for vehicular and pedestrian use shall be clearly demarcated and easily accessible, and shall be designed to minimize pedestrian and vehicular conflicts.

Civic Center and governmental buildings shall have an adjacent buffer area of landscaping, around their perimeter with the exception of entry points. Vehicles may not encroach in this area.

Architecture

The design of Civic Center and governmental buildings shall complement the design of its surroundings. Horizontal and vertical articulation shall be used to visually reduce the massing of the structure.

The building entrance should be clearly distinguishable and easily seen as a major focal point on the building.

The materials and colors used shall reflect those used in accompanying buildings, and be of an equally high quality.

Pedestrian Access

Multiple points of pedestrian access shall be designed for the Civic Center and governmental buildings, and be fully incorporated with the walkways and stairways, parking, open areas, and nearby buildings.

Pedestrian walkways, elevators, escalators, ramps, and stairways shall be well-lit for safety. Where walkways connect through parking lots they should be of sufficient width, excluding car overhangs. A multi-use trail shall be provided from Planning Area 13 down to the regional trail adjacent to Serrano Creek.

Rooftops

The roofs of the Civic Center and governmental buildings should be designed to be integral with the overall building design, and should complement the style and character of the buildings.

Parking Structure

Parking structures, where applicable, shall be designed and constructed to the same level of quality as the buildings they serve. Their design shall be integrated into the site as a whole, making them convenient and accessible for the surrounding Civic Center uses. The maximum height of any parking structure within Serrano Summit shall be the greater of either three stories or 36' in height.

Location

The use of pedestrian connections between parking structures and the uses that they serve shall be convenient, direct, and well-lit for the user. Entries to the parking structure for both vehicular and pedestrian use shall be clearly demarcated and easily accessible, and shall be designed to minimize pedestrian and vehicular conflicts.

The parking structure shall be sited so as not to be a predominant feature of the site. In other words, the parking structure should be placed to the side of the major buildings within the Civic Center complex, so as not to screen the major Civic Center buildings to the greatest extent feasible. It should be noted that the parking structure is contemplated to be constructed in a future phase. Site planning on the Civic Center site shall take into consideration that portions of the surface parking lots will need to accommodate a parking structure as the need arises for additional parking.

Architecture

The design of the parking structure shall complement the design of the uses that it serves. The materials and colors used shall reflect those used in accompanying buildings, and be of an equally high quality.

The parking garage shall be screened by berming and /or landscaping along the ground level for visual

relief. Screening shall be appropriate to the scale of the structure; the planting of tall trees and self-climbing vines is encouraged.

Pedestrian Access

Multiple points of pedestrian access shall be designed into the parking structure, and be fully incorporated with the walkways, stairways, and elevators both within the structure and its accompanying buildings.

Pedestrian walkways, elevators, ramps, and stairways shall be well-lit for safety. Glass elevators and glass-enclosed walkways are encouraged to provide a sense of security.

CIVIC CENTER PLAZA DESIGN

8.2

Purpose & Intent

The design and orientation of buildings directly affects the design of plazas. These plazas serve to encourage socialization by providing open space for public gathering. Combined with well-designed walkways and entries, plazas create an effective, aesthetically-pleasing pedestrian flow from one location to the next.

Successful plaza design is rooted in six key factors:

1. Function
2. Character & Amenities
3. Layout/Scale
4. Sitting Space
5. Environmental Factors
6. Access & Circulation

The Civic Center may include a plaza in its design. The following section is intended to provide design guidance for plazas.

Function

Plazas shall be designed for a variety of functions and activities, both active and passive.

Character & Amenities

Key, unique features should define the design of a plaza. The upkeep of these elements, as well as lighting, fountains, and other similar elements shall be considered during design.

Art

Public art is encouraged within a plaza to add a sense of culture and emotion to the surrounding environment.

Amenities

Amenities such as seating, tables, umbrellas, landscaping, water elements, lighting, bollards, bicycle racks, cigarette urns, and trash receptacles should be provided in the plaza, where appropriate to uses. Such amenities should be conveniently

located where public socializing is common, and should complement the surrounding buildings.

Layout

Plazas should be designed with clear boundaries that visually enclose, create limits and centralize focus onto the plaza. Plazas should be designed to provide a sense of arrival, be scaled appropriate to the environment, and have a unique character enhanced with stairways, vantage points, and repeating patterns—all while being flexible enough to allow a variety of functions to occur within.

Plazas and courtyards should be created through the design and orientation of surrounding buildings on the site, and should be arranged in such a way to create opportunities for safe and effective pedestrian movement between buildings. A formal arrival plaza on-site should be located directly in front of the City Hall at the terminus of 'B' Street. Other plazas should be oriented to maximize viewing opportunities of surrounding open space and distant views.

Building entries and windows, wherever possible, should be oriented towards activities to enhance the activity and security of the space.

Amenities and spaces should be designed at the pedestrian level.

Repetitious forms and patterns, in paving, landscaping, and surrounding articulation, help to identify space and are encouraged.

Sitting Space

Plazas should be designed as an inviting space for users, through the inclusion of varying forms of seating.

Plaza design should include ample site furniture for visitors, allowing users to rest, converse, and observe the area. This should include seating, as well as tables, umbrellas, and other place making features, where appropriate. Site furniture should complement the design of the plaza and surrounding

buildings, and must be of high quality, durable, and resistant to vandalism.

Benches should include backrests and chairs should be well-contoured to make sitting within the plaza physically comfortable.

The placement and orientation of site furniture throughout the plaza should be considered, as well, allowing for individual and grouped seating in both the sun and shade.

Environmental Factors

The design and orientation of plazas should encourage pedestrian use throughout all seasons.

Plaza design and layout shall provide protection from wind, when practical, through the use of canopies, pavilions, and semi-outdoor spaces.

If included, water features should be designed to be accessible and touchable.

Plaza design layouts shall provide adequate shade for the outdoor sitting areas within the Civic Center complex. Shade may be created by providing canopy trees or permanent structures. Structures shall complement surrounding architecture in style, form, or materials, but should be provided at the pedestrian scale.

Access & Circulation

Plazas should be designed to accommodate all age groups and accessibility needs, including consideration of strollers, crutches, canes, walkers, and wheelchairs.

The landscaping component of this section describes the minimum landscape requirements that shall be followed in the design of all public and private improvements within the Civic Center complex. Landscaping shall be used to promote the aesthetic character and value of Serrano Summit and shall:

- Define, unify and enhance the public space;
- Embellish and enhance private areas; and
- Screen views of parking, loading, service areas and utilities.

CIVIC CENTER LANDSCAPING

8.3

General Landscape Standards

All buildings, grounds, slope banks, plazas, and open space areas within Planning Area 13 (Civic Center) of Serrano Summit shall be maintained by the City of Lake Forest or other entity acceptable to the City.

In addition to the City of Lake Forest's standard landscape plans and specifications, and the standards provided in Section 9 - Landscape Design Guidelines of this Area Plan, the following shall apply:

- Any areas not designed for paving or building shall be landscaped and maintained.
- Planning Area 13 is located adjacent to Serrano Creek and therefore falls within the "riparian" tree zone. A strong effort shall be made to provide compatible landscape design with native and existing transitional creek areas.
- Landscaping along Civic Center street edges shall be consistent with, and complement, the landscaping of surrounding uses along that street.
- Civic Center landscaping shall make use of street trees having a minimum size of 24" box spaced at regular intervals of between 30' - 40' o.c., while maintaining an average tree spacing of 35' o.c. throughout. As accents, plantings of informal clustered massings of California native trees are encouraged with a minimum size of 15 gallons, where applicable.
- The perimeter landscape of the Civic Center complex shall reflect the character of Serrano Summit and shall strengthen its community landscape theme.
- The design of the Civic Center shall employ water conservation techniques to provide a sensible and complete landscape solution for the center.
- Underground drainage shall be used to drain landscaped areas.
- Automatic irrigation infrastructure shall be permanently provided in all landscaped areas, except for those designed as swales for water quality purposes. Moisture-sensing and water-monitoring devices shall be used, in compliance with drought and water conservations standards adopted by the City of Lake Forest.
- The use of California-friendly plants, mulch, installation of drip irrigation systems, minimizing of impervious areas, and the designing of landscaped areas as shallow swales to retain irrigation water is encouraged, where feasible, to reduce water use.
- Site features, such as bicycle racks, recycling bins, planters, and benches, should be designed as an integral part of the project.
- A landscape and irrigation plan shall be submitted to the City of Lake Forest for review and approval prior to issuance of building permits.

Street Frontage Landscape Standards

Landscaped areas along street frontages shall be appropriate to the scale, orientation, and purpose of the area and consistent with the Area Plan. Tree and shrub locations and layouts shall be consistent with other existing sections of the street. Installation of street frontage landscaping along the Civic Center frontage shall provide for a seamless streetscape, thereby integrating into the overall community.

Parking Lots

The following standards shall be applied to the Civic Center parking lot landscaping in Planning Area 13 of Serrano Summit:

- The parking areas should not block pedestrian access between buildings and the public street. These areas should be designed to allow for pedestrian through-connectivity, through the use of walkways with enhanced paving, trellis structures, and/or landscape treatments.
- Trees located within parking lots shall be located within planters, with a spacing as determined by local jurisdiction. Minimum tree size within planters shall be 24 inch box.
- Planters shall have a minimum inside width of 5', and be bounded by a concrete curb, unless intended to be used as landscaped swales for NPDES water quality protection purposes.
- An end cap planter, with a minimum inside width of 5', should be provided at each end of all

rows within the parking lot. Planters shall have a minimum length equal to the longest adjacent parking space, inclusive of curb.

- Tree canopies in planters may not be lower than 7' above the ground.
- Additional landscaping in parking lot planters shall not obstruct the ability for police or security to properly view the area.
- Parking lots should be designed to serve for vehicle parking, while also serving as an open, uninterrupted multi-functional plaza for special events. This requires that the parking spaces be simply striped and minimizing the use of planters with raised curbs and concrete wheel stops.

Where feasible, parking lots should be divided into a series of connected smaller lots. This can be accomplished by incorporating one of the following:

- A landscaped bulb should be used to break up parking lots, with a maximum of 15 contiguous spaces in a row and 10 spaces in a row on average.
- A landscape tree well shall be installed every 5 parking spaces between landscape bulbs.

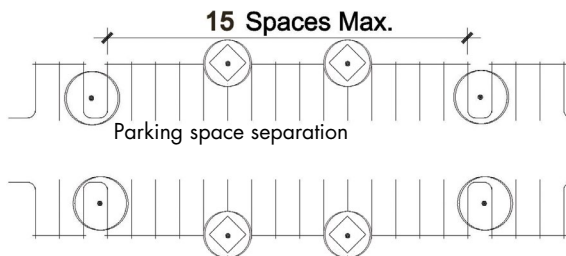

In addition, parking areas should be treated as "landscape plazas," with attention to landscape surfaces, softened edges, shade, and pedestrian circulation. This can be accomplished by incorporating at least one of the following:

- Pedestrian walkways should connect public rights-of-way and residential land uses when appropriate.

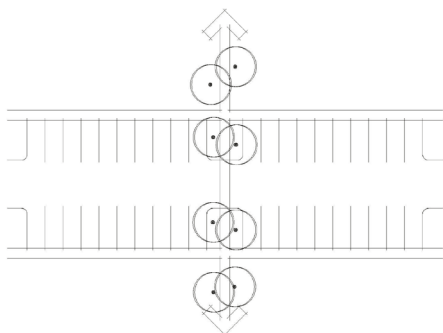

Pedestrian Access in Parking Areas

- Enhanced paving materials, trellises, and landscaping should be used to accentuate the pedestrian circulation system.

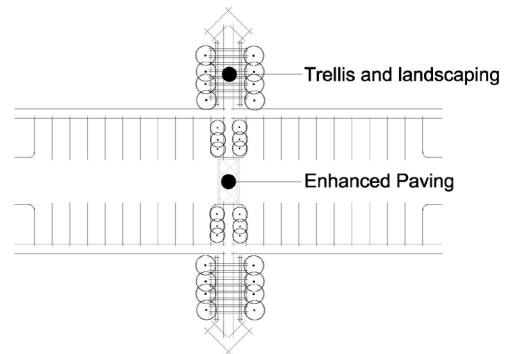

Enhanced Pedestrian Circulation

Acceptable Plant Materials

The planting concept for the Civic Center complex should be consistent with the concept for the rest of the community, when feasible. See Section 9 - Landscape Design Guidelines for an approved plant palette for the community. The City shall have discretion to select plant materials for the Civic Center complex; provided, however, it is strongly encouraged to incorporate the use of native and riparian compatible species, where appropriate. Should the site develop with residential uses, then the standards in Section 9 - Landscape Design Guidelines within this Area Plan shall apply.

CIVIC CENTER SIGNAGE

8.4

Civic Center Signage Guidelines

Signage guidelines for the Civic Center complex shall allow for City and affiliated uses and individuality, while maintaining a high level of quality and complementing signage located throughout the community.

Within this section, Civic Center sign guidelines are addressed in eight components:

1. General Sign Program Guidelines
2. General Design Requirements
3. Monument Signs
4. Business Directory & Directional Signs
5. Wall-Mounted Signs
6. Temporary Signs
7. Sign Illumination
8. Prohibited Signs

Signs will be reviewed during the City's design review process for their consistency with these guidelines, and the Serrano Summit Area Plan as a whole.

General Sign Program Guidelines

Civic Center signage shall be regulated by a uniform sign program, and submitted to the City of Lake Forest for review in conjunction with building construction and approval. Submittals shall include drawings and details sufficient for review by the City, including as appropriate:

- Elevation(s) of the buildings for which signs are being requested, showing design, location, size, and layout of wall signs. Elevations shall be drawn to scale indicating dimensions, attachment devices, and construction details.
- Site plan of the site for which signs are being requested showing building and perimeter with location of proposed and existing ground-mounted monuments and elevations showing proposed design and dimensions of signs.
- Section through letter and/or sign panel showing the dimensioned projection of the letter face and/or sign panel. The method of illumination shall also be identified.

General Design Requirements

- All signs should be designed to be appropriate with the scale and proportion for the buildings on which they are placed and the areas in which they are located.
- All signs shall be designed to be aesthetically pleasing, and visually complement the style of the building on which they are located or identifying, as well as the community as a whole.
- All permanent signs shall be used for the purpose of identification and direction only. Advertising is not permitted on permanent Civic Center signage.
- Permanent ground-level signs are limited to identification monument signs, directory signs, directional signs, and on-site regulatory signs.
- Sign colors shall be chosen for legibility and shall complement the style of the Civic Center use and community as a whole. Substantial contrast should be provided between the color and material of the background and the letters or symbols for ease of reading in both and night conditions. The sign panel background should be free of distracting details and decoration.
- Lettering should be designed and applied to avoid shadow distortions.
- Sign materials shall be durable and of a high quality. Metal signs may be made of aluminum, brass, bronze, copper, or stainless steel and may be painted.
- The City of Lake Forest shall be responsible for the proper maintenance of the signs, and shall routinely inspect signage within the Civic Center site to ensure an attractive appearance at all times. If at any time the City of Lake Forest determines that the signs or other elements of the signs are damaged or indicate a noticeably deteriorated appearance, the City shall replace or otherwise refurbish the sign to restore it to its original appearance.
- Street address signs shall be displayed for each building.
- Sign types not covered in this program shall follow the City of Lake Forest Municipal Code.

Temporary Signs

- Temporary signs include all non-illuminated signs that identify, or provide basic information about, future facilities, for sale/for lease opportunities and construction activities, or for special events. No other temporary signs are permitted.
- Temporary signs include panels, placards, and banners and are prohibited on the exteriors of Civic Center and governmental buildings, roofs, walls, or fences. Small temporary directional signs may be permitted for special events.
- Temporary signs are not permitted at intersection corners or within ten feet of the street curb in the Civic Center area.
- The City is responsible for the removal of all balloons, banners, and other temporary signs by the end of the last day of the event. All helium balloons must be removed by the end of the day in which balloons are put up. No helium balloons shall be cut loose to fly freely; all helium filled balloons as permitted by the sign program shall be discarded in a designated trash bin or receptacle.
- Signs providing sales, leasing, and construction information are allowed and shall follow the guidelines from the City of Lake Forest Municipal Code.

BUS SHELTERS IN CIVIC CENTER AREA

8.5

The visual appearance and design of bus stops and the allocation of bus stop amenities that enhance pedestrian comfort and safety play a significant role in the decision to use mass transit. Amenities should be provided to improve the attractiveness of mass transit as a means of transportation to and from the Civic Center areas, thereby reducing parking needs.

General Standards & Guidelines

The design of bus stops shall be directed through coordination with the Orange County Transportation Authority (OCTA), or their applicable design standards, if provided.

Shelters shall be designed with the following factors taken into consideration:

- The durability and strength of materials.

- The resistance of chosen materials and paint treatments to weather conditions, graffiti, cutting, fire, and other forms of vandalism.
- Consideration of potential greenhouse effect during hot weather.
- The balance of external lighting within the Civic Center area with that within the bus shelter.
- Design which complements that of the Civic Center area.
- Wheelchair accessibility within the shelter.
- Inclusion of trash can and newspaper boxes within the design.
- Communications conduits for future use.
- The use of a semi-transparent material that allow bus operators to see within the shelter.
- Wheelchair marking/placard that indicates the space underneath the shelter dedicated for wheelchairs.

WALLS & FENCES IN CIVIC CENTER AREA

8.6

General Standards & Guidelines

Walls and fences within the Civic Center area should be consistent with that elsewhere within the Serrano Summit boundaries, as regulated in the Walls & Fences component of Section 9 - Landscape Guidelines.

Walls and fences construction shall complement building design within the Civic Center area, and be constructed of community-appropriate materials, colors, and textures.

Fencing facing Serrano Creek shall be “open,” view-type fencing.

Refuse & Recyclable Material Storage Areas

- Refuse and recyclable materials storage areas shall be enclosed and screened in compliance with the City of Lake Forest Municipal Code.
- Storage areas should be screened from public view through the use of landscaping, fencing or walls or a combination thereof.
- Where appropriate to the building typology, refuse and recyclable material containers should be integrated into the overall building form to facilitate screening.
- Enclosures shall be finished using materials compatible with the Civic Center architecture. Gates shall be painted solid metal.
- The location of storage areas shall be conveniently accessible for trash removal by standard refuse disposal vehicles.
- Storage areas that can be overlooked from above should incorporate roof structures to screen the contents of the enclosure from view. Such roof structures should be designed to allow the doors of the refuse container to fully open.

Loading & Service Access

- Service, loading, storage, and maintenance areas shall be screened from public view where reasonably possible.
- No loading will be permitted from any public street adjacent to Planning Area 13.
- Service areas must be located and designed so that service vehicles have clear and convenient access and do not prohibit adjacent vehicular or pedestrian circulation or vehicular parking.
- The final locations of loading/service areas will be approved by the City of Lake Forest.

CIVIC CENTER AREA LIGHTING

8.7

General Standards & Guidelines

The Civic Center area lighting component addresses the illumination of the Civic Center area for the purposes of safety, security, and nighttime ambience, including lighting for parking areas, pedestrian walkways, architectural and landscape features, and any additional exterior areas.

- A comprehensive lighting plan shall be prepared and approved in conjunction with the site plans submitted for approval to the City Planning Department. In addition, all plans shall be reviewed and approved by the City of Lake Forest Police Department/Orange County Sheriff's Department.
- Exterior lighting within a parking lot, service area, or other intentionally lit area should be located and designed to minimize direct glare outside of the specific area.
- Lighting sources shall be shielded, diffused, or indirect in order to avoid glare to pedestrians and motorists. Lighting fixtures should be selected and located to confine the area of illumination to within the boundaries of the Civic Center area.
- Pedestrian paths should be lighted by pole, directed up lighting, or bollard-type fixtures that are in scale with the pedestrian, typically no more than 16' for pole lights or 3' in height for bollards. All lighting fixtures shall be designed to resist vandalism.
- A balance of lighting for building users and lighting of architectural features should be

emphasized to provide user-friendly interior and exterior schemes with the main consideration being the aesthetic effect of the lighting design.

- Night lighting and security lighting shall be sensitively designed to ensure that no off-site glare is directed toward neighboring uses and that the overall intensity of the site lighting is not excessive. The use of excessive nighttime security lighting is discouraged, with other security measures being considered, instead.
- Downward-directed building illumination placed below the horizontal building line helps reduce glare and adds an aura of class to the façade.
- Skyward-directed lights designed to attract attention, such as searchlights or moving lights, are prohibited.
- Lighting near to and adjacent to open space areas shall be designed to minimize sky glow and glare in order to minimize light pollution and be sensitive to Serrano Creek.
- Street lights should be located between street trees to provide light that is uninterrupted by tree canopies.
- Freestanding lighting styles shall be post, column, or double column types.
- Building signs illuminated above or below by spotlights are permitted.
- Lighting fixtures, poles, wattage and lens for all site, walkways, parking lot, and street lights shall match community lights for overall community continuity.

TABLE 8-1
SUMMARY OF LIGHTING DESIGN CRITERIA

USE	LIGHT LEVELS*	UNIFORMITY RANGE	DISTRIBUTION	LIGHT SOURCE
Roadways	0.4	20:1	Full Cutoff	Metal halide, induction
Roundabout	0.5	15:1	Full Cutoff	Metal halide, induction
Pedestrian Walkways	0.5	10:1 Primary 15:1 Secondary	Full Cutoff or Cutoff	Metal halide, induction
Plazas	0.5	15:1	Full Cutoff or Cutoff	Metal halide, induction
Entries	1.0	15:1	Full Cutoff, Cutoff, or Semi-Cutoff	Metal halide, compact fluorescent, LED, induction
Landscape			Shielded	Metal halide, compact fluorescent

*Average footcandles.

CIVIC CENTER GREEN BUILDING STANDARDS

8.8

As part of the Area Plan's objective to create an energy efficient community of choice, the Civic Center within Serrano Summit may incorporate ecological practices and green development techniques. This can be achieved through energy conservation, reduction of non-renewable resources, and California-appropriate landscape practices.

Such practices include lessening the impact of the built environment through energy reduction as well as the reduction and reuse of non-renewable resources. While a third party program is not required for the Civic Center within Serrano Summit, participation in voluntary programs such as the US Green Building Council's Leadership in Energy and Environmental Design (LEED) is encouraged.

By adopting green building standards, savings on heating and cooling costs are possible in addition to becoming eligible for various grants and tax credits.

This section includes a few of the many green standards that are highly encouraged to be used within the Civic Center complex.

- High efficiency lighting:
 - ~ *The installation of high efficiency lighting, such as CFLs (compact fluorescent lighting), greatly reduces energy consumption.*
- Low energy cooling system, such as engineered HVAC systems with tight HVAC Ducts
 - ~ *Low energy HVAC systems that are installed with tight ducts increase the efficiency in heating and cooling the building.*
- Improved drywall, insulation, and sealing installation
 - ~ *Proper installation helps to maintain the desired temperature inside the building, lessening the dependence on mechanical heating and cooling systems.*
- Cool roofs
 - ~ *A cool roof reflects and emits the sun's heat back to the sky instead of transferring it to the building below. "Coolness" is measured by two properties, solar reflectance and thermal emittance. The higher the value, the "cooler" the roof. By limiting heat penetration into the building, dependence on mechanical cooling systems can be reduced. Rooftop gardens function in this manner.*

- Dual-glazed LoE2 windows with high-efficiency glazing (SHGC and U-value < 0.40)
 - ~ *Dual-glazed Lo E2 windows limit heat and coldness penetration, therefore reducing the need for mechanical heating and cooling.*

In addition, other energy efficient design elements are encouraged. Such elements include, but are not limited to:

- On-site renewable energy systems (PV solar panels and solar water heaters)
 - ~ *Roof-integrated photovoltaic cells can be used to offset energy consumption.*
- Natural Ventilation – Window Placement and Building Orientation
 - ~ *Proper window placement and building orientation allows for natural ventilation, thus lessening the dependence on mechanical cooling systems.*
- Architectural shade elements
 - ~ *Architectural shade elements (such as overhangs and awnings) protect against excess sun from entering buildings, keeping them cool during the hot summer months.*

Reduction of Non-Renewable Resources

The reduction of non-renewable resources is an important aspect of green design. Such reduction practices include, but are not limited to:

- Utilization of Environmentally Preferable Building Materials
 - ~ *Environmentally preferable building materials such as non-virgin, renewable, and recyclable materials aid in the reduction of non-renewable resources.*
- Construction and General Waste Recycling Program
 - ~ *On-site recycling and/or donation of scrap materials to local charitable organizations greatly reduce construction waste.*
- Low-flow Water Fixtures
 - ~ *Low-flow water fixtures limit the amount of water used on a per-building basis.*

California-Appropriate Landscape Practices

Elements of California-appropriate landscape practices include, but are not limited to California-friendly landscape, water-conserving irrigation practices, and energy conservation. These practices include but are not limited to:

- Water-Wise and California-Friendly Landscape
 - ~ California-appropriate vegetation that reduces the use of water may be incorporated into the Civic Center's landscaping. See Section 9 - Landscape Guidelines for the Master Plant Palette.
 - ~ Plants with high water demand are encouraged to be located in shade areas or near creek and open drainage areas.
 - ~ The use of turf grass should be limited to active use areas only. Groundcovers and drought-tolerant grasses that require less water should be used in non-active areas.
 - ~ Plants of similar water requirements shall be grouped to allow more effective use of irrigation.
 - ~ The extensive use of mulch, decomposed granite, or gravel is encouraged in landscape areas to improve water-holding capabilities of soil through reduced evaporation and compaction.
 - Water-Conserving Irrigation Practices
 - ~ Utilizing point-irrigation systems is encouraged to allocate more efficient delivery of water to root systems and minimize run-off.
 - ~ Utilizing master irrigation systems (smart systems) with moisture sensors is encouraged to ensure irrigation watering is based on actual need for irrigation watering and to allow a greater level of control in the management of irrigation.
 - ~ Using recycled water in large, public open spaces is encouraged.
 - Energy Conservation through Landscape Design
 - ~ Community and Civic Center area landscapes are encouraged to be designed to assist with energy conservation, including planting deciduous trees next to buildings and along streets to reduce ambient temperature, reduce heat gain, allow for cool natural ventilation, and provide a more pleasant pedestrian environment.
 - ~ Deciduous trees and vines are encouraged to be planted in front of south-facing walls and windows to further cool buildings by intercepting sunlight during summer months, yet allow direct sunlight during the winter.
- ~ Green screens (lattices planted with vines and/or climbing flowers) are encouraged to shade south and west-facing walls to reduce interior heat gain and beautify buildings.
 - ~ Trees with appropriate heights and spreads are encouraged to provide ample shade in the summer months for outdoor spaces such as plazas, pedestrian walkways, roadways and parking lots are encouraged. Structures such as trellises and porticoes may also be incorporated into the building/landscape edge, especially on south and west-facing exposures, to provide shade in the summer and allow solar penetration when the sun is at a low angle in the winter.
 - ~ Landscape buffers, screens and windrows are encouraged to be located so they facilitate cooling by prevailing breezes in summer months are encouraged.

LANDSCAPE DESIGN GUIDELINES

Section 9.0

November 2016



COMMUNITY LANDSCAPE

9.1

The following design guidelines establish a hierarchy of the landscape design principles for Serrano Summit and its surrounding roadways. Careful attention is given to creating an appropriate and appealing landscape design that complements and enhances the overall character of Serrano Summit. All landscape plans, streetscape plans, and graphic designs with regard to community identity, neighborhood

identity, or entry monumentation shall conform to the guidelines as set forth herein, and will be subject to review and approval by the City of Lake Forest.

LANDSCAPE THEME

9.2

The goals of the community landscape at Serrano Summit are as follows:

- A master landscape theme that complements the internal Land Use Plan;
- Take advantage of the idyllic site;
- Promote and preserve long distant views and vistas;
- Work organically with the natural surrounding hillside and vegetation;
- Promote a feeling that you arrived at “somewhere special,” a place that has preserved the past;
- Environmentally sensitive and California friendly;
- Landscape to be California-friendly and a leader in “water wise” design;
- Promote lifestyle activities which “blur” the separation between indoor and outdoor spaces; and
- Display remnants of an Early California Rancho. These subtle expansions authentically inspired by the land’s Spanish roots.

The landscape theme for the Serrano Summit community should work hand-in-hand with the Site Plan. This community is an infill development that has spectacular views which the Land Use Plan strives to promote and preserve. The landscape design should complement and reinforce that direction. The landscape, which includes site amenities, hardscape and softscape elements, should promote a consistent theme. (See Exhibit 9-1, Community Landscape Features, and Exhibit 9-2, Conceptual Landscape Master Plan.)

The theme for Serrano Summit is Early California, celebrated by preserving small pockets or remnants of Spanish stylistic roots. The natural riparian vegetation from Serrano Creek will be expanded and incorporated into the community from the North. The low-growing, native “hillside vegetation” will transition into the project from the western and southern slopes. This approach will help integrate the community with its surroundings and promote a “well rooted,” organic and established appearance typical of Early California Spanish design.

THIS PAGE IS INTENTIONALLY LEFT BLANK.



THIS PAGE IS INTENTIONALLY LEFT BLANK.



INTERNAL SLOPES

Trees
Vary depending on "District"

Shrubs

Agave attenuata	N.C.N.
Anigozanthos manglesii	Kangaroo Paw
Bougainvillea 'Hawaii'	Variiegated Bougainvillea
Carissa grandiflora 'Boxwood Beauty'	Natal Plum
Feijoa sellowiana	Pineapple Guava
Leucophyllum laevigatum	Chihuahuan Sage
Lomandra longifolia	Breeze Dwarf Mat Rush
Raphiolepis species	Indian Hawthorne
Rosmarinus o. 'Prostratus'	Trailing Rosemary
Senecio mandraliscae	N.C.N.

RIPARIAN ZONE FUEL MODIFICATION

Trees

Alnus rhombifolia	White Alder	18/22
Heteromeles arbutifolia	Toyon	8/10
Platanus racemosa	California Sycamore	16/19
Quercus agrifolia	Coast Live Oak	14/16

Shrubs

Artemisia caucasica	Caucasian Artemisia
Baccharis salicifolia	Mulefat
Ceanothus species	N.C.N.
Eschscholzia californica	California Poppy
Fremontodendron californicum	California Flannelbush
Ribes speciosum	Flowering Gooseberry

MSE WALLS

Shrubs

Bougainvillea 'Hawaii'	Variiegated Bougainvillea
Eschscholzia californica	California Poppy
Lantana sellowiana 'Monna'	White Lightn' Trail Lantana
Lomandra longifolia	Breeze Dwarf Mat Rush
Rosmarinus o. 'Prostratus'	Trailing Rosemary
Myoporum parvifolium	Myoporum

CALIFORNIA FRIENDLY HILLSIDE FUEL MODIFICATION

Trees

Platanus racemosa	California Sycamore	16/19
Quercus douglasii	Blue Oak	15/17
Rhus lancea	African Sumac	13/16
Sambucus mexicana	Mexican Elderberry	10/14

Shrubs

Artemisia caucasica	Caucasian Artemisia
Baccharis 'Centennial'	Coyote Brush
Ceanothus species	N.C.N.
Eschscholzia californica	California Poppy
Hesperaloe parviflora	Red Yucca
Lupinus bicolor	Sky Lupine
Nassella (Stipa) pulchra	Purple Needlegrass
Opuntia littoralis	Prickly Pear
Yucca whipplei	Our Lord's Candle

MANUFACTURED OUTBOARD FUEL MOD SLOPES

Trees

Cercis mexicana	Mexican Redbud	11/13
Heteromeles arbutifolia	Toyon	8/10
Platanus racemosa	California Sycamore	16/19
Quercus agrifolia	Coast Live Oak	14/16
Sambucus mexicana	Mexican Elderberry	10/14

Shrubs

Agave attenuata	N.C.N.
Alyogyne huegelii	Blue Hibiscus
Artemisia caucasica	Caucasian Artemisia
Baccharis 'Centennial'	Coyote Brush
Ceanothus species	N.C.N.
Cistus hybridus	Rockrose
Eschscholzia californica	California Poppy
Mimulus species	Monkeyflower
Opuntia littoralis	Prickly Pear
Quercus dumosa	Coastal Scrub Oak
Rhus species	Sugar Bush



THIS PAGE IS INTENTIONALLY LEFT BLANK.

GENERAL LANDSCAPE CRITERIA

9.3

General Provisions

1. All landscape plans shall comply with the City's Water Efficiency Landscape Ordinance (Ordinance 207). All landscape and irrigation plans for streetscapes and graphic designs with regard to the identity of Serrano Summit, neighborhood identity or entry monuments shall conform to the Design Guidelines and regulations as set forth herein and shall be subject to Design Review by the City of Lake Forest. The form and content of landscape plans for streets, parks, and other common areas shall conform to City application requirements.
 2. The design and improvement of all public parks, open space, paseos and trail, including landscape and irrigation plans, within Serrano Summit shall be reviewed and approved by the City of Lake Forest Parks Department.
 3. Installation of landscaping and automatic irrigation within the front yards of all residential areas shall be provided by the home builder. At a minimum, the builder will install ground cover and appropriate shrubs and trees in the front yards of homes within residential areas, consistent with landscape plans approved during the site development plan or use permit process. At a minimum two trees shall be installed, of which at least one, is a shade tree. A variety of front yard landscape designs shall be provided by the developer for use by homeowners. Within single family attached residential areas the builder shall be responsible for the installation of full landscape improvements within the development. Areas not used for hardscape shall be landscaped. All landscape plans shall be reviewed and approved by the City of Lake Forest and shall be designed to incorporate water conservation measures.
- the entire perimeter property line or on manufactured slopes between properties.
 2. Landscaping and automatic irrigation systems within the public rights-of-way of Serrano Summit shall be installed by the developer.
 3. Freestanding perimeter walls and view fencing shall be provided within, and at the perimeter of, Serrano Summit as specified in Section 9.13, Walls and Fences. Such walls and fences will be constructed concurrently with the construction of improvements required for development of the neighborhoods of the Serrano Summit boundaries.
 4. Perimeter walls shall be constructed in locations and of a design consistent with the "Fence and Wall Plan" and "Block Wall" exhibits located in Section 9.13, Walls and Fences. Perimeter walls shall not exceed six feet in height from finished grade. If required for sound attenuation, perimeter walls may exceed six feet in height but must be constructed using transparent material, subject to the recommendations of an acoustical study and approval by the City. Perimeter walls shall be constructed of either masonry or other permanent, durable, low maintenance material. Thematic perimeter fencing shall be constructed of all durable materials, which may include materials with a wood-like appearance, or tubular steel subject to approval by the City. In no instance shall wooden fencing be permitted along perimeters.
 5. Individual residential lot side and rear yard walls and fencing shall not exceed six feet in height from highest adjacent finished grade. Side and rear walls may exceed six feet (6') in height if required by the City of Lake Forest for sound attenuation pursuant to the recommendations of an Acoustical Report. Walls and fencing within the residential front yard setback area shall not exceed three feet in height. Side and rear yard walls shall be of decorative masonry construction on both sides of the wall or other permanent low maintenance materials. Front yard fences may be constructed of wood or any other durable materials with a wood like appearance, subject to approval by the City. View fencing may be of a decorative wrought

Landscape Standards

1. Landscaping within Serrano Summit shall be provided in accordance with the Landscape Design Guidelines, utilizing plant materials specified on the Master Plant Palette included in Section 9.16. Boundary landscaping will be required adjacent to residential areas. Landscaping shall generally be placed along

- iron, tubular steel/aluminum glass panels, or other durable material approved by the City.
6. All perimeter wall and fence materials throughout Serrano Summit will be of uniform manufacture with colors specified for the overall design theme.
 7. Non-toxic vegetation shall be utilized adjacent to all public open space areas to the extent feasible.
 8. Landscape design shall emphasize the planting of long-lived plant species that are native to the region or well adapted to the climatic and soil conditions of the area.
 9. The landscape design should help create and reinforce the distinct character of various features within the natural and man-made environments.
 10. The landscape treatment of all areas shall emphasize the planting of shade trees in both formal and informal groupings throughout the community.
 11. The use of non-invasive, California-friendly plant materials that are climate-appropriate shall be utilized where appropriate.
 12. Landscape plans for any development shall consider service lines, traffic sight line requirements, and structures on adjacent properties to avoid conflicts as trees and shrubs mature.
 13. Street trees and trees planted near walkways or street curbs shall be selected and installed to prevent damage to sidewalks, curbs, gutters and other improvements.
 14. Plants with high water demand are encouraged to be located only in areas where runoff naturally occurs.
 15. The use of turf grass should be used in active use areas only. Groundcovers and drought-tolerant grasses that require less water should be used in non-active areas.
 16. Planting design (species, quantity, size and spacing) shall achieve a minimum of 70% ground plane coverage within two (2) growing seasons from installation.
 17. The ground plane shall be covered with a minimum 2" layer of decorative material to improve water-holding capabilities of soil through reduced evaporation and compaction.
 18. The use of decorative gravel is encouraged as a design element to offer a variety of colors and texture within landscape areas. The size of the material is to be suitable so as to remain in place once it has been installed.
 19. Install a 12" minimum border of decomposed granite/decorative gravel along back of curb within the parkway to minimize irrigation overspray into the gutters.
 20. Public/private areas shall be separated with a 6" by 6" concrete mow strip when adjacent to private property.
 21. Turf areas shall be sized and shaped to optimize irrigation efficiency. Turf type and location shall be selected in the same manner as other plantings. Turf shall not be treated as a fill-in matter but rather as a planned element of the landscape. All turf areas shall be on separate irrigation zones. The following conditions shall apply:
 - a. *No turf may be used on slopes greater than 4:1.*
 - b. *No more than 50 percent of homeowner's property outside the building envelope shall be planted with turf; this reduces water usage by requiring a greater amount of private landscape to utilize a climate-appropriate landscape palette.*
 - c. *Turf should only be used in active areas.*
 - d. *Turf areas less than eight (8) feet wide on the shortest side shall be irrigated with subsurface irrigation or micro spray heads.*
 - e. *Irregular shapes that cannot be irrigated efficiently shall be avoided.*
 - f. *Artificial turf shall be permitted within Serrano Summit planning areas, with the exception of areas designated as Open Space (i.e., Planning Area 18).*

IRRIGATION PRACTICES AND DESIGN

9.4

Irrigation for both public and private landscapes should be designed to be water-efficient and water-wise. All irrigation systems shall be designed to properly water plant materials given the site's climate and soil conditions. The following is a list of some of the guiding principles for an appropriate irrigation system design:

- All public areas and rights of ways shall have automatic irrigation systems and shall be compatible with reclaimed water systems.
- Utilizing a weather-based master irrigation controller system that employs current weather data and a rain shut-off device to ensure that the irrigation schedule is based upon actual "real time" plant needs. This allows for a greater level of control within the irrigation system and minimizes potential water waste.
- Utilization of point-irrigation (drip) systems is encouraged to allocate more efficient delivery of water to root systems and minimize run-off.
- The use of overhead spray heads is discouraged in non-turf applications. The use of point irrigation or sub-surface irrigation dripline root zone irrigation system negates overspray and reduces water waste.
- Spray systems shall have low volume (gpm) matched-precipitation heads.
- Turf areas shall be irrigated with equipment that has a precipitation rate of one (1) inch or less per hour as specified by the manufacturer. Stream rotator heads are preferred; use of standard spray heads shall be avoided.
- All irrigation products specified shall achieve an irrigation operational distribution uniformity of 70% or greater in all turf areas and 80% in all other landscaped areas.
- Using reclaimed water in large, public open spaces is highly encouraged, if available.
- Design irrigation system based upon solar exposure. Irrigation heads should be grouped in South/West and North/East exposures. This ensures that heads with similar sunny exposure will be grouped together on the same valve and heads with similar shaded exposure will be grouped together.
- All major tree groupings shall have an additional support irrigation system providing water to each individual tree utilizing a flush grade

bubbler system on a separate valve in order to more efficiently manage water demand.

LANDSCAPE TREE DISTRICTS

9.5

To ensure that the concept and theming established for the community as a whole extends to the residential neighborhood level (above and beyond the parks and gardens that are required), Serrano Summit has been divided into landscape tree districts (see Exhibit 9-3, Landscape Tree District Plan) that are comprised of multiple planning areas.

While community-wide landscaping criteria will provide a visual continuity throughout the community, a collection of defined landscape tree districts have been established to distinguish specific neighborhoods, collections of neighborhoods, or other specialized zones. Each landscape tree district will establish criteria reinforcing its unique characteristics and thematic elements within the context of the larger community.

A landscape tree district may be defined by the characteristics of an area's:

- Predominant architectural theme
- Location and proximity to natural open space areas or other significant site features
- Specific land uses (residential, public facility, Civic Center)

Subtle variations in landscape will occur between landscape tree districts, creating a distinguishable and unique sense of place for each district.

All landscape tree district criteria shall be complimentary to the overall community landscape concept.

The Serrano Summit community is divided into several distinct "Tree Neighborhood Zones." The intent of these "Tree Zones" is to help reinforce each district's own sense of unique identity while still strengthening the overall community's theme. These zones are designed to simulate nature and blend into the overall regional viewshed. They are also based on geographic factors such as elevation, slope orientation, canyons, as well as proximity to significant groves of existing native trees. Each "Tree Neighborhood Zone" has its own tree palette of related tree species which are visually compatible based on form, pattern, texture and color. All internal street trees and 75% of all trees located on manufactured slopes, transition areas and fuel

modification zones shall be from the designated tree palette for that neighborhood zone. The remaining 25% of trees, along with all trees on buildable pad areas, may be selected from the overall landscape plant palette. This concept provides a simple method of precluding a "patchwork" effect from lot to lot, helps to unify the landscape framework, and provides some diversity while avoiding mono-culture.



Riparian Zone



California Hillside Zone



Coniferous Forest Zone

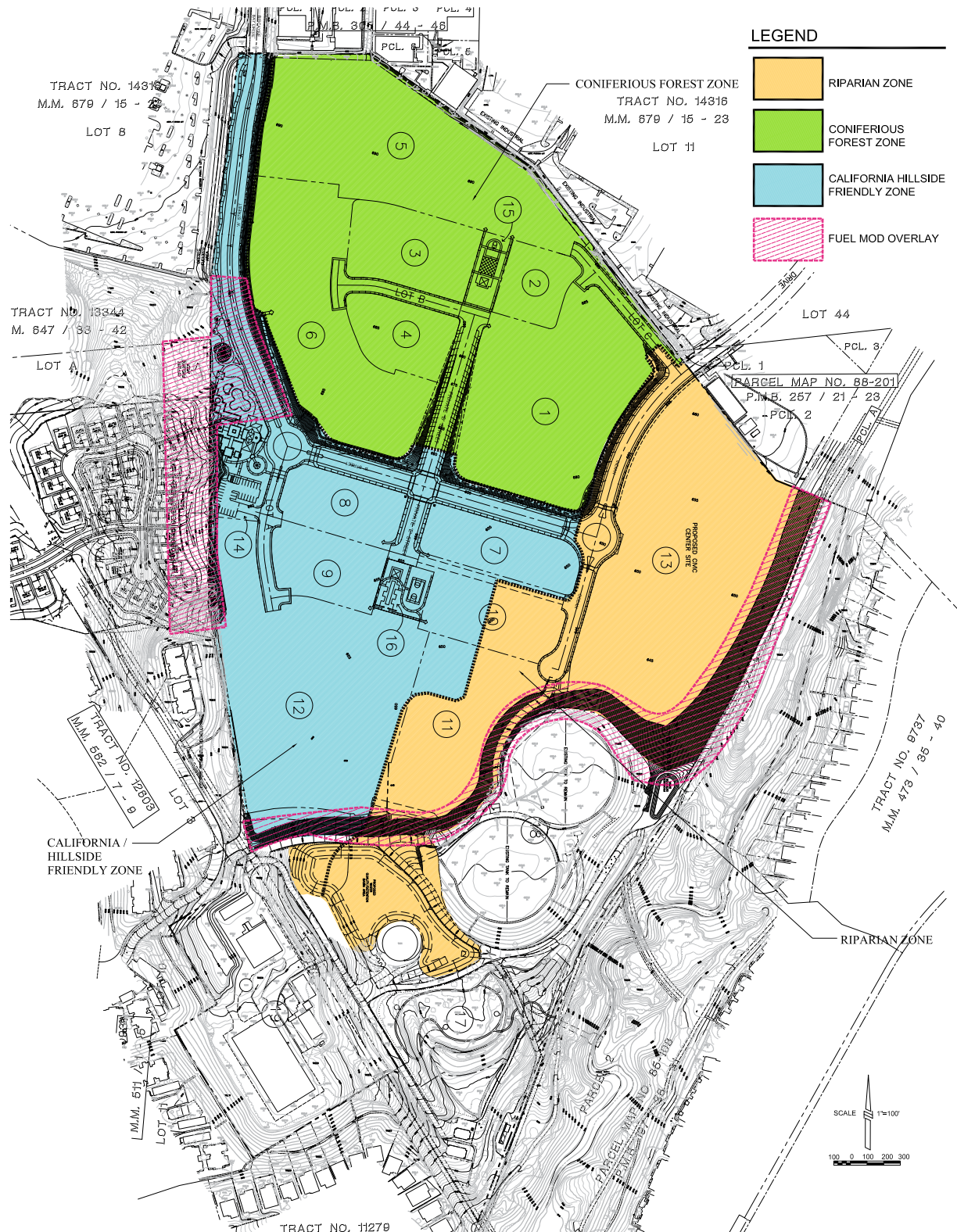

TIERED LANDSCAPE PROGRAM

9.6

Landscaping for Serrano Summit shall follow a tiered planting concept as shown in General Tiered Planting Requirements Table (see Table 9-1). This concept shall be consistent throughout the community, from perimeter streetscape design to residential front yards. Using different scales, forms, colors, and/or textures of plant materials, tiered – or layered and promotes interest and diversity. The application of tiered planting is required to enhance the visual character of the project by softening the appearance of walls and fencing along major community roadways. The tiered concept shall also be applied at the neighborhood level (along collector and local streets) and in front of individual residential units or multifamily housing projects. A selection of acceptable planting materials is found in the Master Plant Palette (see Section 9-16).

**TABLE 9-1
GENERAL TIERED LANDSCAPING
REQUIREMENTS**

LAYER	DESCRIPTION	SIZE
LAYER A	Low spreading groundcover (1) (including turf or turf substitute)	Under 12" height
LAYER B	Low mounding shrub/ groundcover (1)(2) (informal mass planting)	12"-30" height
LAYER C	Low hedge (formal - linear)	12"-30" height
LAYER D	Medium shrub (2) (informal mass or hedge)	24"-48" height
LAYER E	Large shrub (2) (informal mass or hedge)	42"-60" height
LAYER F	Vertical (growth habit columns rather than horizontal)	42"-72" height
ACCENT	Strategically located specimens	Varies

FOOTNOTES

1. Groundcover material shall be permeable and able to retain moisture in the root zone, as well as reduce dust and weeds. Examples of appropriate ground plane materials include decomposed granite (3/8" minus with 11% fines), fractured gravel (3/4"-1"), fractured rock (2"-6"), river rock (4"-9"), shredded bark, and ornamental grass.
2. Shrubs shall be a minimum of 5-gallons in size; in any "multi-layer" scheme. For shrubs serving as the first (shortest) layer, a 1-gallon shrub size or rooted cutting is acceptable.

The Specific Tiered Landscaping Requirements Table (see Table 9-2), provides details on how to approach multi-layered landscaping in front and side yards, slopes and large open spaces.

**TABLE 9-2
SPECIFIC TIERED LANDSCAPING
REQUIREMENTS**

PLANTER WIDTH	NUMBER OF LAYERS REQUIRED		
	FRONT YARDS	STREET-ADJACENT SIDE YARDS	SLOPES & LARGE OPEN SPACE
18"-30"	1	1	1
30"-48"	2	2	1
48"-60"	2 or 3	2	1
60" & up	3	3	-
5'-12'	-	-	2
12' & up	-	-	2 or 3

Accent planting is encouraged depending on length of planter and could, depending on its use, count as a layer.



STREETSCAPE DESIGN

9.7

Landscape design plays a crucial role in effective street design that goes beyond form and aesthetics. Streetscape connects neighborhoods allowing a smooth circulation of both vehicular and pedestrian traffic. It addresses comfort, safety, security and accessibility for residents and visitors. Streets in neighborhoods will be designed to be enjoyable, walkable and interactive to pedestrians. The streetscape hierarchy consists of two levels of streetscape design: Community- and neighborhood-level streetscape (see Exhibits 9-4 to 9-10).

Community-level streetscapes/street tree patterns shall be designed in a manner to define the unique character of the Serrano Summit community.

Neighborhood-level streetscapes shall be designed to reinforce the more intimate character of residential areas.

In some areas within the community, corners of adjacent residential lots shall be thematically landscaped for transition into neighborhood and community spaces. Wall treatments will become more visually distinct with decorative pilasters accentuated by accent trees and plants. Trees shall be strategically located to not interfere with driving visibility.

Refer to streetscape tree list (see Table 9-3) for exact tree species for each street within Serrano Summit.

Community-Level Streetscape Design

Streetscape design guidelines establish a hierarchy for the landscape development along the collector roadways, as well as establishing a framework for consistency of design. Three collector streets service the Serrano Summit community: 'A' Street, 'B' Street, and Indian Ocean Drive. (See Exhibits 9-4 to 9-6)

The following criteria shall be followed:

- All collector streets shall be planted in accordance with the Serrano Summit streetscape design.
- Street trees will be at a minimum size of 24" box in size.

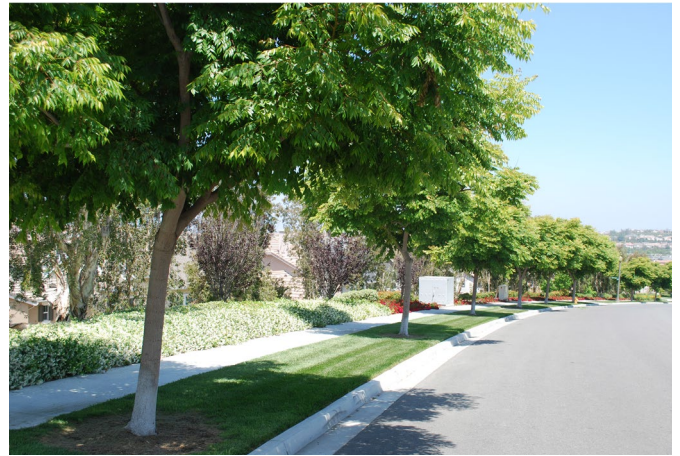

TABLE 9-3
STREETSCAPE TREE LIST

BOTANICAL NAME	COMMON NAME	PERIMETER ROAD 'A'	PERIMETER ROAD 'A' BACKGROUND/UNDERSTORY	'B' STREET	'B' STREET BACKGROUND/UNDERSTORY	INDIAN OCEAN STREET TREE	INDIAN OCEAN BACKGROUND/ UNDERSTORY	PRIVATE 'D' STREET	INTERIOR NEIGH. STREET TREE/ RIPARIAN ZONE	INTERIOR NEIGH. STREET TREE/ CA. HILLSIDE ZONE	INTERIOR NEIGH. STREET TREE/ CONIFEROUS FOREST ZONE	ACCENT POINTS	CORNER TREATMENTS	ALLEY
Acacia smallii	Sweet Acacia									•				
Arbutus 'Marina'	Strawberry Tree				•									•
Callistemon viminalis	Weeping Bottle Brush									•				•
Cedrus deodara	Deodar Cedar										•	•		
Cercis mexicana	Mexican Redbud	•												
Cercidium h. 'Desert Museum'	Thornless Hybrid Palo V.									•				
Chitalpa tashkentensis 'Pink Dawn'	Chitalpa											•		•
Cinnamomum camphora	Camphor Tree					•	•							
Cupaniopsis anacardioides	Carrotwood								•					
Cupressus sempervirens	Italian Cypress											•		•
Dracaena draco	Dragon Tree	•										•		
Lagerstroemia farnesia 'Hybrids'	Crape Myrtle									•	•	•		
Magnolia grandiflora 'D.D. Blanchard'	Southern Magnolia										•			
Melaleuca quinquenervia	Cajeput Tree								•					
Pinus canariensis	Canary Island Pine										•			
Pinus eldarica	Afghan Pine										•			
Pinus pinea	Italian Stone Pine										•			
Platanus acerifolia 'Bloodgood'	London Plane Tree			•						•				
Platanus racemosa (1)	California Sycamore	•				•		•						
Prosopis glandulosa 'Thornless'	Thornless Texas Honey Mesquite									•				
Pyrus calleryana 'Aristocrat'	Aristocrat Flowering Pear											•		•
Quercus agrifolia (1)	Coast Live Oak								•	•				
Rhus lancea	African Sumac									•				
*Schinus molle	California Pepper Tree	•												
Tipuana tipu	Tipu Tree							•						
*Tristania conferta	Brisbane Box	•		•		•					•			
Ulmus parvifolia 'True Green'	Evergreen Elm											•		
Umbellularia californica (1)	California Bay								•					

(*) Denotes trees that are to be avoided in wind prone areas.

(1) Denotes trees that are native to California.

- Root barriers will be used, as necessary, to discourage root growth invasion on pavement.
- Average street tree spacing shall not exceed 30' o.c.
- All trees and plant materials shall correspond with the approved trees and plant list to reinforce community theme.
- All trees planted within turf areas will require arbor guards to prevent damage to the trunk.
- Understory trees and shrub masses should be planted in series of tiered layering (foreground, midground, background) to help define borders and plant groupings while combining interesting foliage textures and color.
- Background and screen trees shall be strategically planted behind sidewalks to help create a green backdrop supporting the street tree canopy.

Landscape development surrounding the community will help to establish the character, while maintaining consistency with the City of Lake Forest.

Neighborhood-Level Streetscape Design

Neighborhood-level streetscape design within Serrano Summit shall be consistent in character with the community-level streetscapes and should promote pedestrian circulation throughout the community. The Neighborhood-level Streetscape Design shall consist of the following elements:

- Private Drive Streetscapes
- Private Alley Streetscapes
- Unique or Special Streetscape Scenarios

Private Drive Streetscape

The landscape design should reinforce the distinct character of the neighborhood (or landscape tree districts) while still continuing the expression of the overall community image, and provide efficient pedestrian and vehicular circulation routes (See Exhibit 9-9).

The neighborhood streetscape should include:

- All trees and plant materials will correspond with the approved trees and plant list to reinforce community theme.
- Street trees will be at a minimum of 24" box with required caliper and dimension standards.

- Root barriers will be used to discourage root growth invasion on pavement.
- There should be strong connections between "Community Core" and neighborhood identity.
- Sufficient space must be provided between driveways and garden walls to allow for the growth of the tree trunks
- Thorn trees must be avoided in areas where children play or ride bicycles.
- Appropriate sized tree canopies scaled to fit the specific street as required. Small and medium sized canopy shade trees are encouraged.

Private Alley Streetscape

Private lanes shall include a landscaped area on both sides of the lane when the paved area is a maximum of 24' in width (See Exhibit 9-10 and 9-11). The following criteria is to be followed wherever feasible:

Condition 1

When planter is less than 24" deep, provide a vertical decorative metal trellis support with (1) 5 gallon climbing vine and (2) 1 gallon accent shrubs at a minimum.

Condition 2

When a planter is more than 24" deep or greater, provide (1) 5 gallon minimum plant (column form) and (2) 1 gallon accent shrubs at a minimum.

Condition 3

For long linear foundation planters, provide (1) 5 gallon minimum plant (column form) at garage and 5 gallon plants (hedge form) at 24" o.c. for the duration of the building wall. Omit column form plant when planter is 18" to 24" deep.

All trees and plant materials will correspond with the approved trees and plant list to reinforce community theme.

Unique or Special Streetscape Scenarios

This section is intended to address project-specific requirements that are outside of the standard template. Scenarios such as:

- Existing streetscape elements that are to be maintained or enhanced.
- Perimeters or streetscapes that abut large WQMP facilities.

Section 9 - Landscape Design Guidelines

Entry points leading into the community are essential in creating a sense of place and identity for Serrano Summit. Community and neighborhood entry points shall use landscape design elements that reflect a relative hierarchy for entering each area of the community. The landscape design at the entrances shall be representative of the stylistic character of the area's design. The following are methods through which this hierarchy and continuity will be established:

- Entry points shall be accentuated through an enhanced landscape of accent plant material including trees, palms, shrubs and groundcovers.
- Changes in height, texture and color of plant material will highlight visibility, provide a skyline treatment and enhance the entry process



thereby introducing the overall landscape, direction and theme of Serrano Summit.

- Size and scope of the project's monumentation program should be reflective of the scale of the project. In smaller projects, primary and neighborhood monumentation may only be required to provide the appropriate sense of entry and the appropriate "way-finding" function whereas larger projects may require the entire scope of monumentation to provide the same function.
- Enhanced accent paving is encouraged at community entrances to define the entrance and provide traffic calming.
- Entry points shall have thematic signage and markers for identity and emphasis. Their design shall remain consistent throughout the entire community.
- Wall treatments on entry points may employ the use of rich colors and materials that ties in with adjacent architecture styles for character.
- Four basic monument treatments are used to create the hierarchy of the entries and monumentation: the Primary Community Entry and Monumentation, Secondary Community Entry and Monumentation, Neighborhood Monumentation and Public/Civic Monumentation.

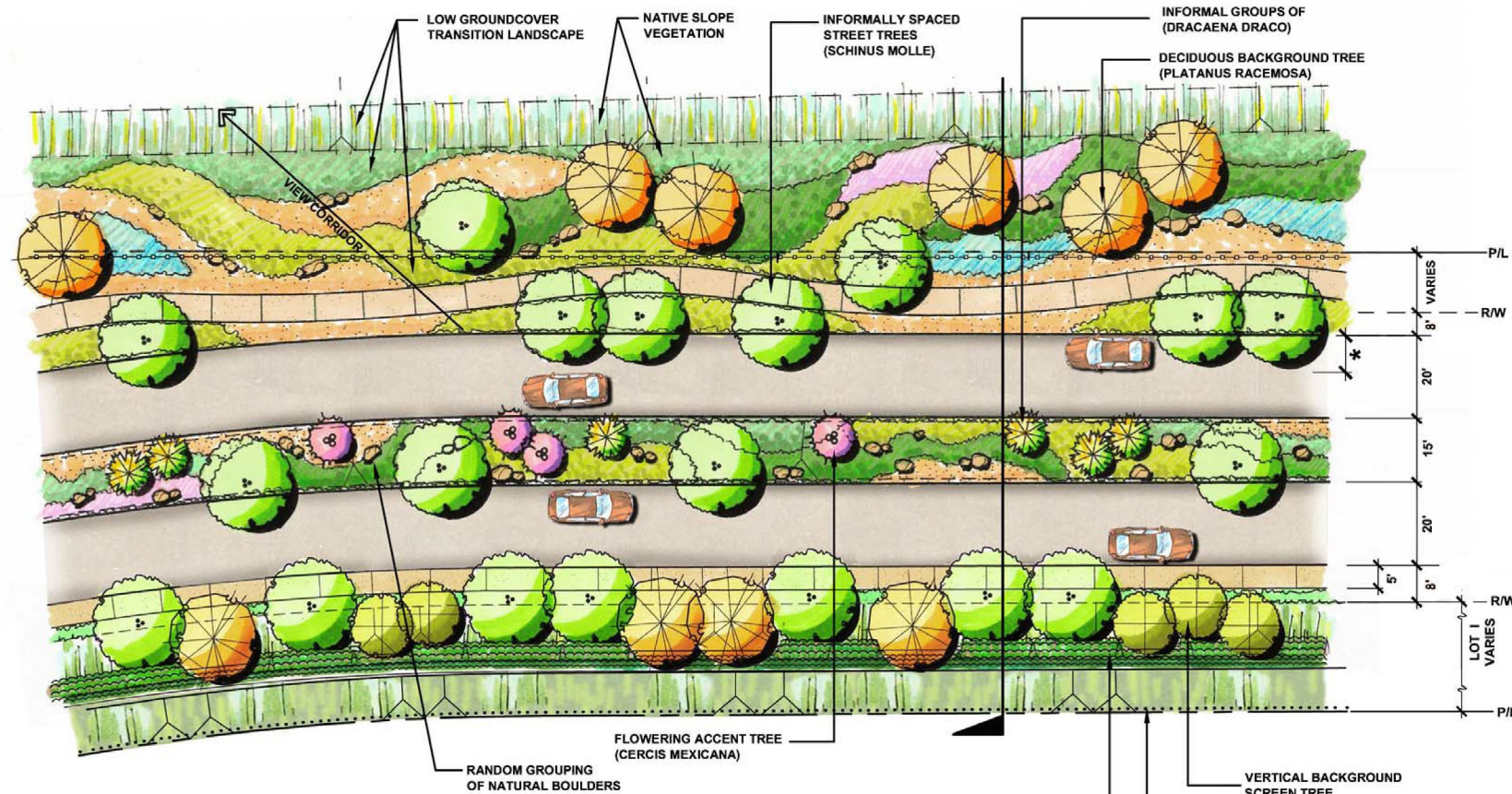

PLAN VIEW

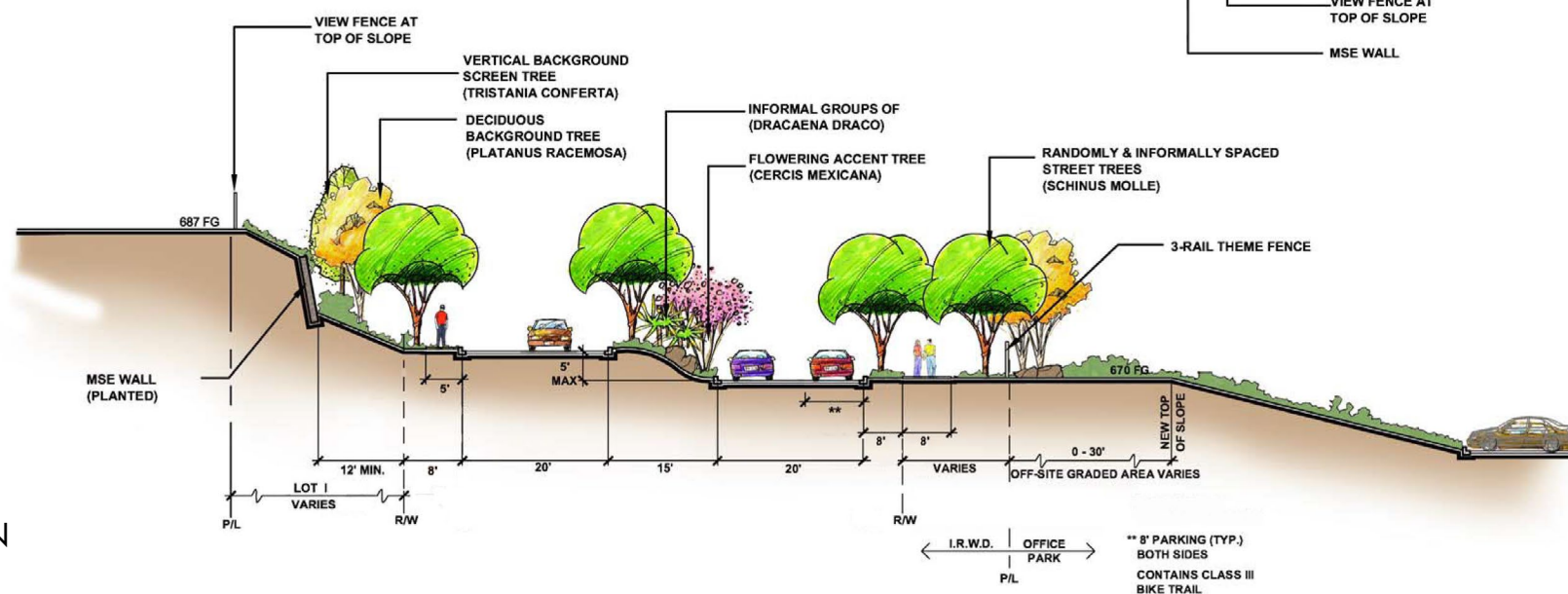

SECTION



Schinus molle
(California Pepper Tree)



Cercis mexicana
(Mexican Redbud)



Dracaena draco
(Dragon Tree)



Platanus racemosa
(California Sycamore)



Tristania conferta
(Brisbane Box)

THIS PAGE IS INTENTIONALLY LEFT BLANK.

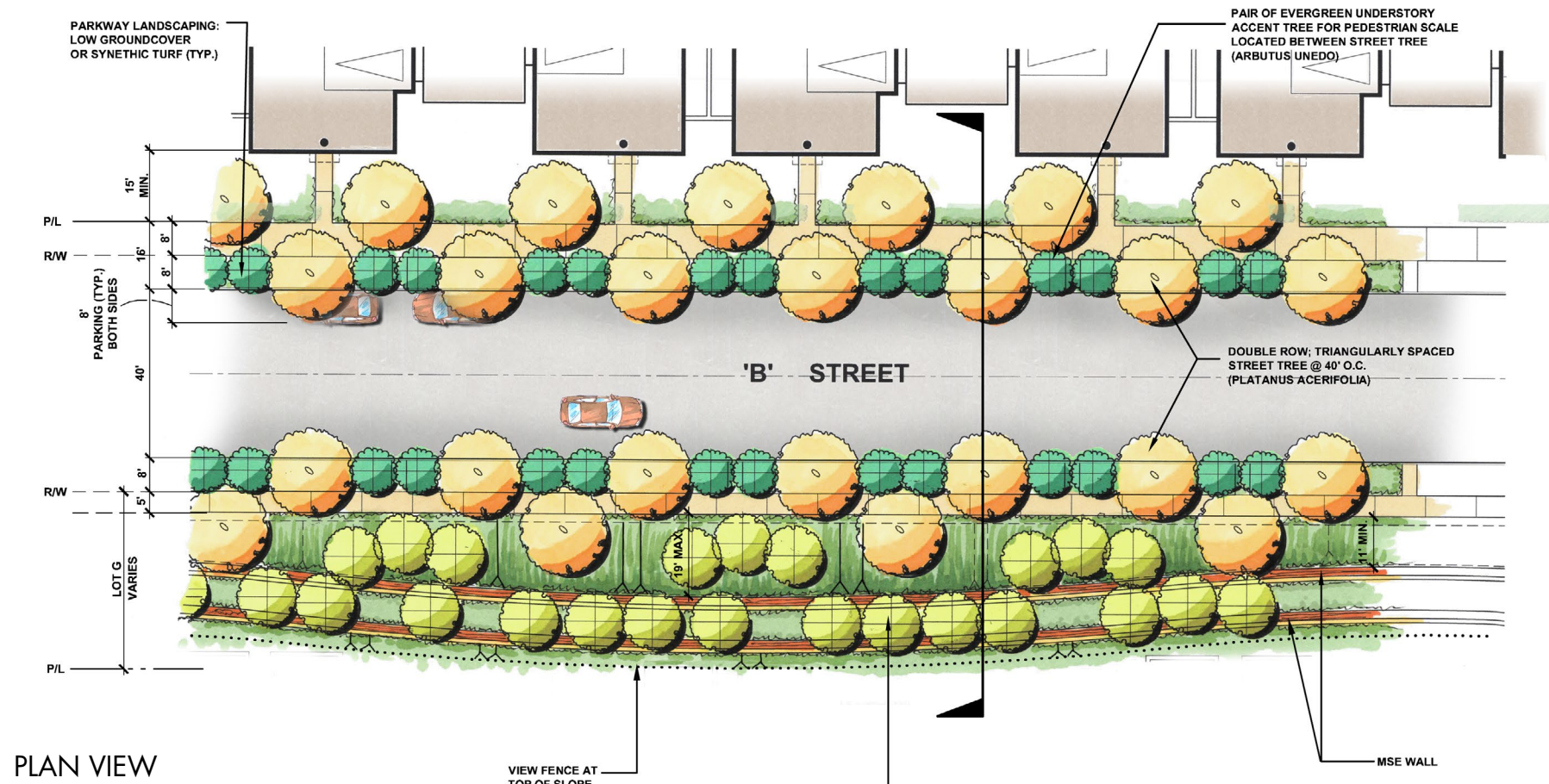

PLAN VIEW

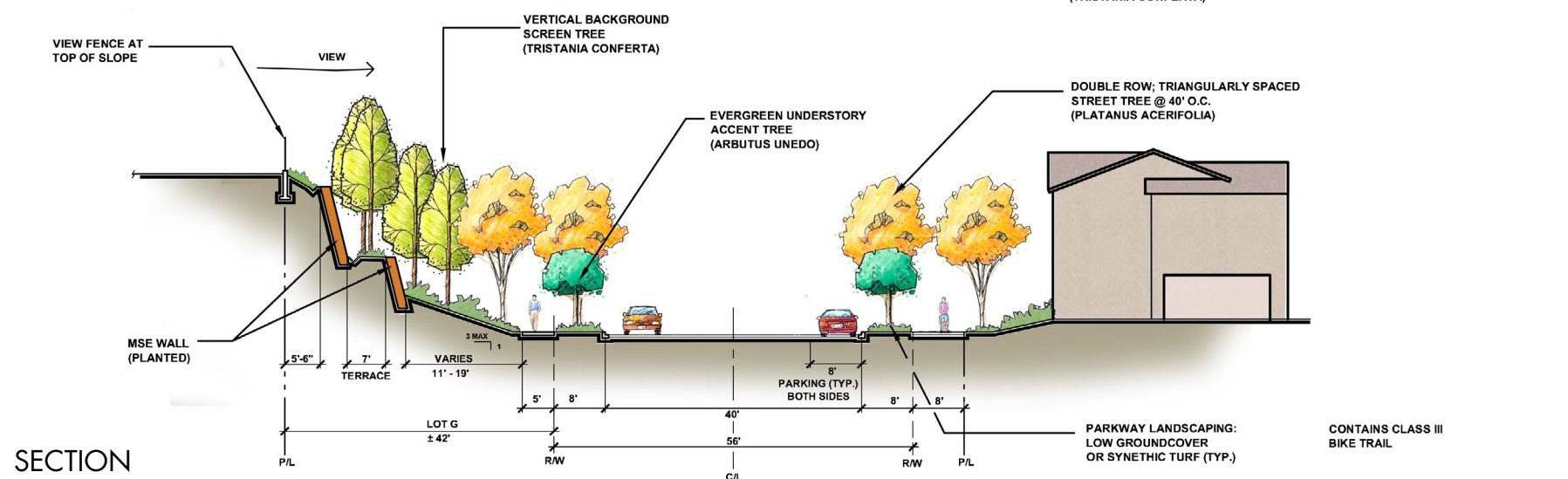

SECTION



Platanus acerifolia
(London Plane Tree)



Arbutus unedo
(Strawberry Tree)



Tristania conferta
(Brisbane Box)

THIS PAGE IS INTENTIONALLY LEFT BLANK.

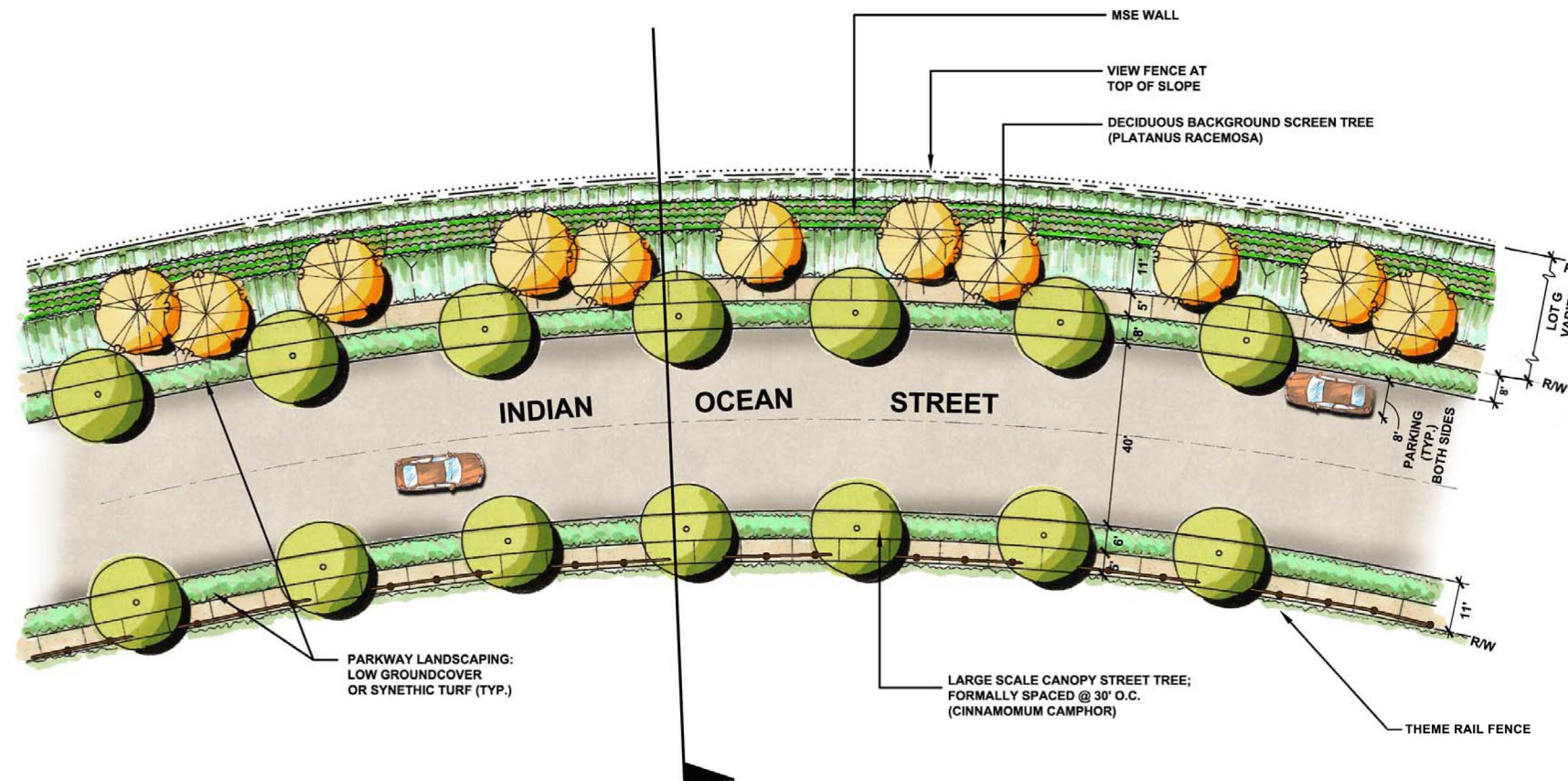

Platanus racemosa
(California Sycamore)

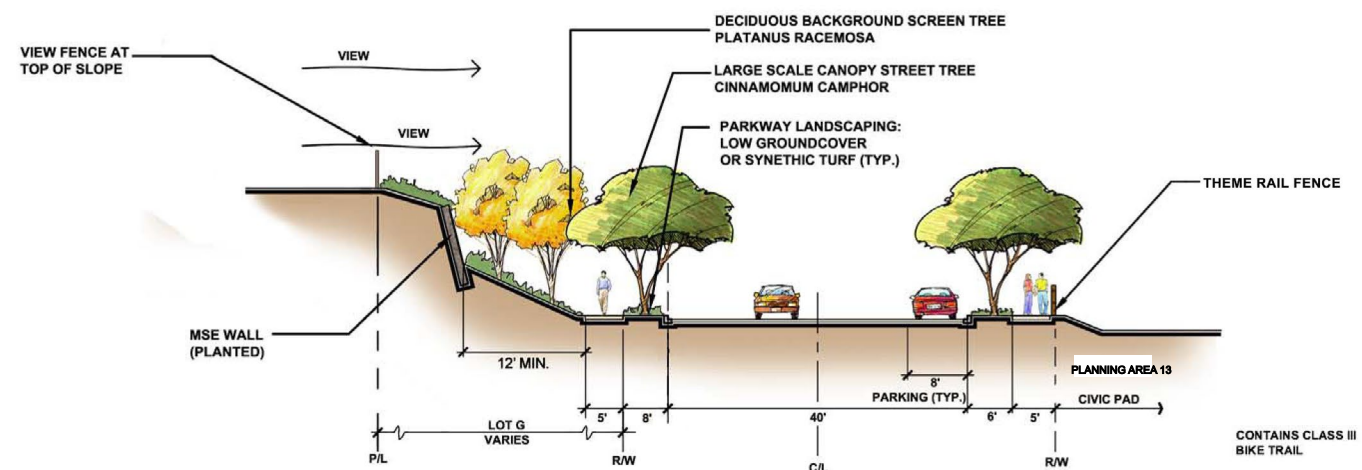

Cinnamomum camphora
(Camphor Tree)

THIS PAGE IS INTENTIONALLY LEFT BLANK.

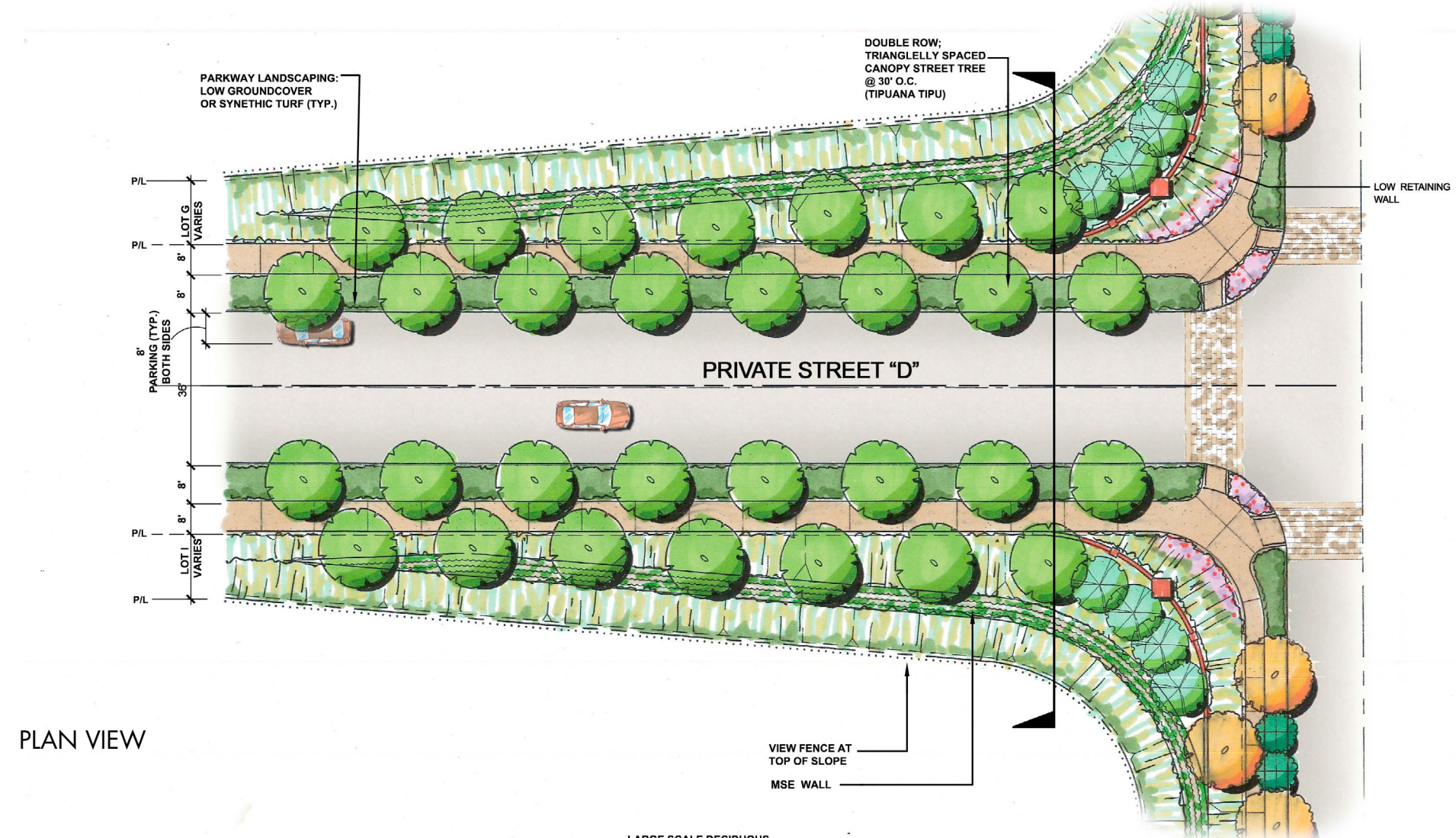

PLAN VIEW

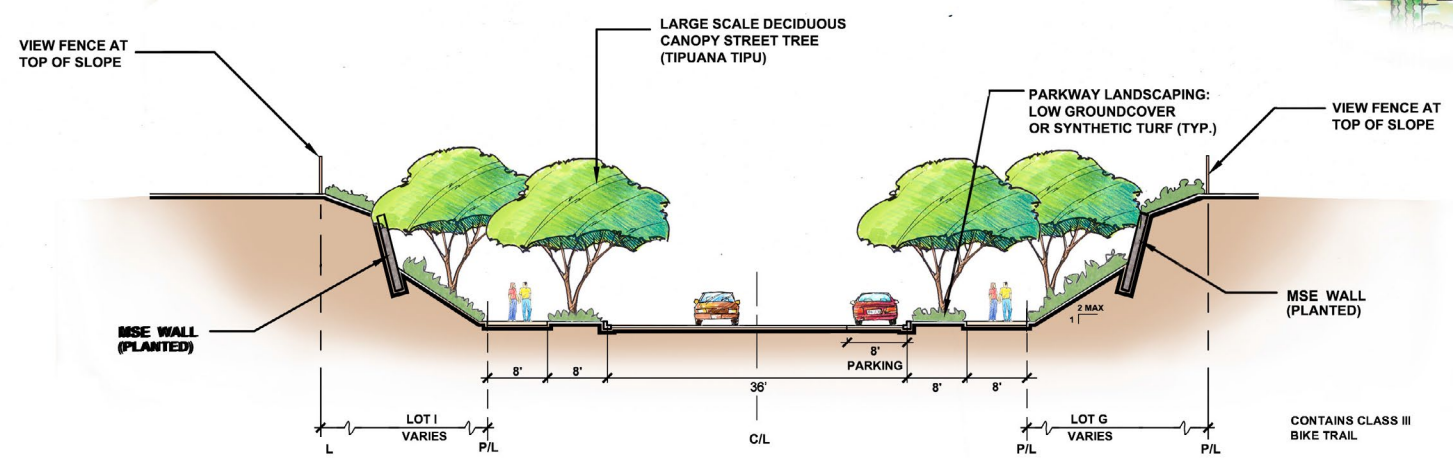

SECTION



Tipuana tipu (Tipu Tree)



Tipuana tipu (Tipu Tree)



Tipuana tipu (Tipu Tree)

THIS PAGE IS INTENTIONALLY LEFT BLANK.

PRIVATE LOCAL STREET STREETSCAPE (WITH ON-STREET PARKING)

EXHIBIT 9-8

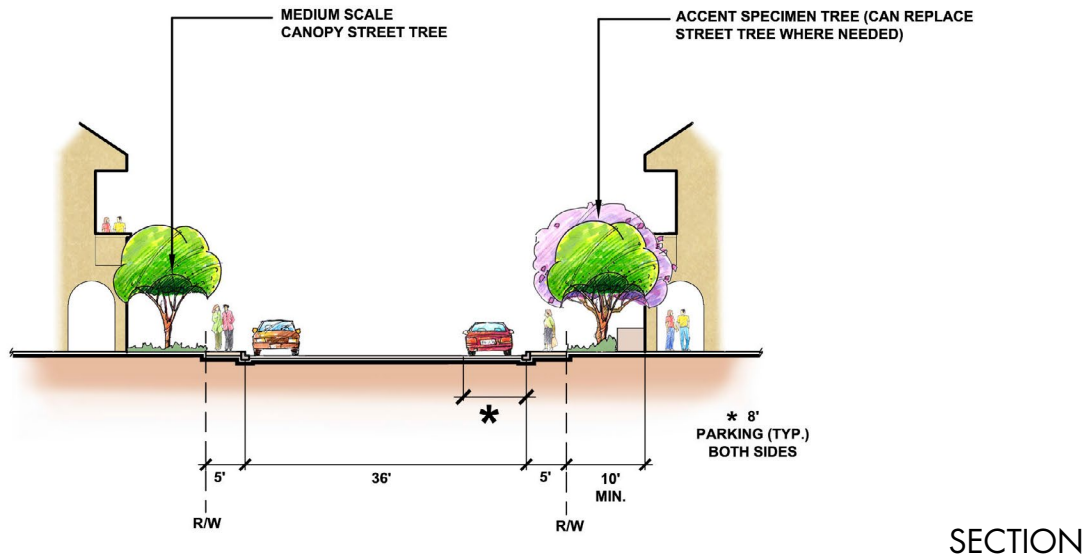
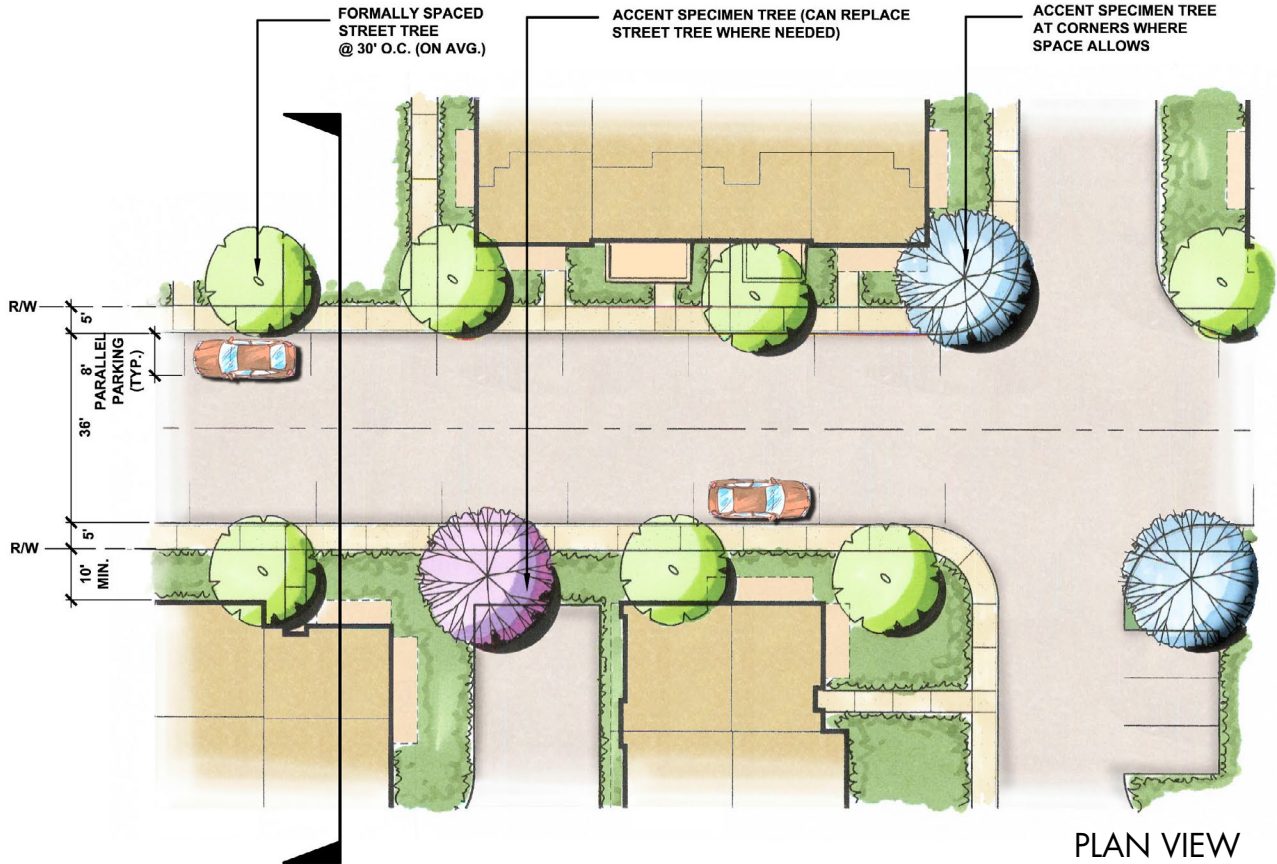

PRIVATE ALLEY DRIVE STREETSCAPE - SINGLE FAMILY RESIDENTIAL

EXHIBIT 9-9

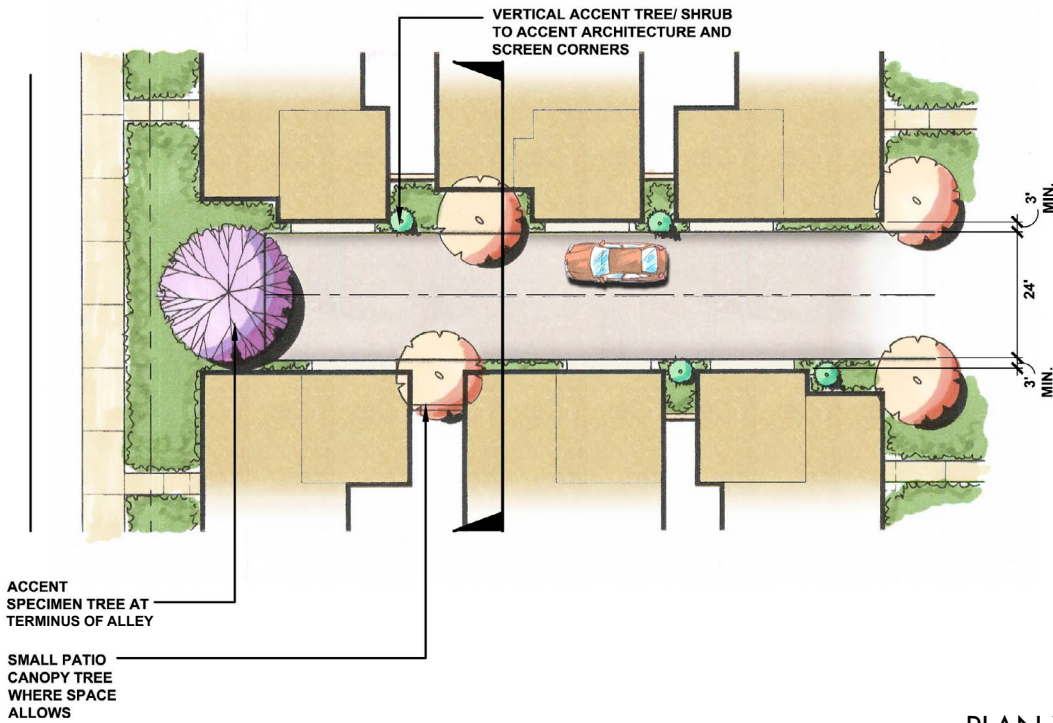

PLAN VIEW

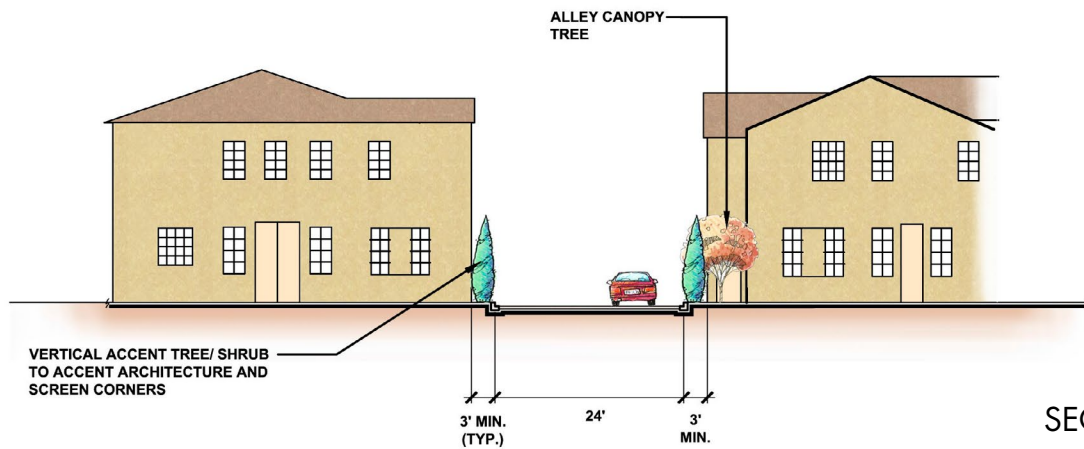

SECTION

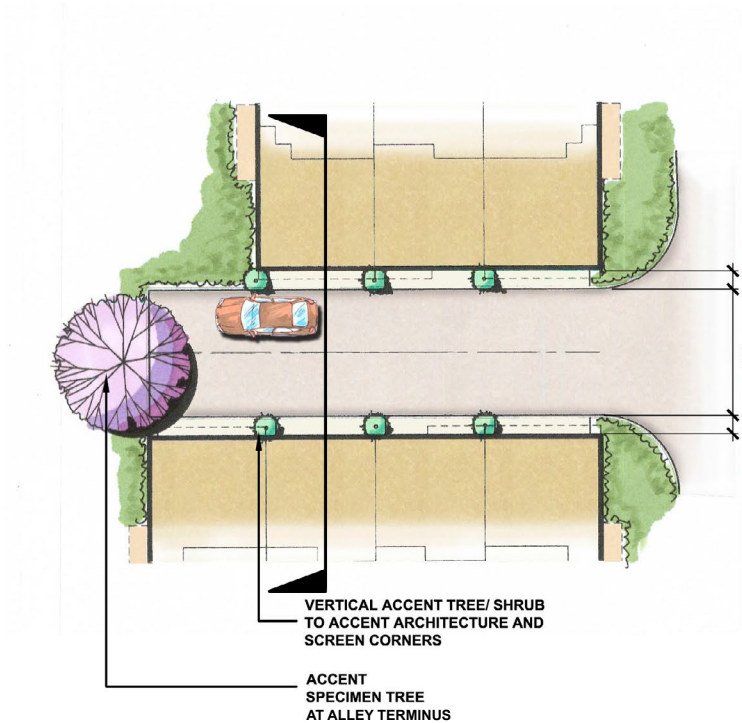

PLAN VIEW

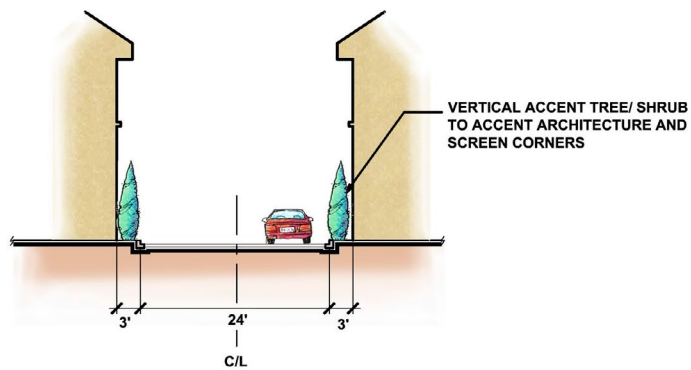

SECTION

COMMUNITY & NEIGHBORHOOD ENTRIES AND MONUMENTATION 9.8

Community Entry & Monumentation

The key entries leading into the community are identified on (see Exhibit 9-1, "Conceptual Master Landscape Plan"). The purpose of the entries is to announce the community identity and establish the unique character and theme through Serrano Summit. The introduction of stylized plant groupings that reflect the architectural theme of the community landscape are central to the success of the Community Landscape Theme (see Exhibits 9-11 to 9-12).

Highlights

- Community entries shall include tree-lined streets to announce arrival, enhance character and appeal that will inspire visitors and residents.
- All trees and plant materials shall correspond with the approved trees and plant list that corresponds to community theme and appropriate scale.
- Community entries shall have themed monumentation to enhance the arrival experience.
- Themed walls shall accent the entry process
- Monumentation should provide an appropriate area for community signage.
- Incorporate architectural caps, trims and bases to help delineate architectural detailing.
- Provide accent lighting of landscape/monumentation

Method

- Use of focal evergreen trees with a minimum size of 48" box.
- Use of flowering accent trees with a minimum size of 36" box).
- Massing of a variety of minimum 5 gallon shrubs and groundcovers in planting beds located at entry points and roadways.
- A mixture of decomposed granite, decorative rock and boulders may be utilized to create the ground plane within the entry and median:
- Stone Veneer finish shall be El Dorado Molano with rustic "overgrout" application or similar.

- Enhanced paving shall be 80 mm thick antique cobble or stamped A.C. paving.

Iconic Intersection Landscape Treatment

There shall be a special landscape treatment created at the intersection of 'B' Street and 'D'/'E' Streets (private) as shown on Exhibit 9-1, Conceptual Landscape Plan. The intersection landscape design shall make use of unique plant material such as accent plantings.

Highlights

- All trees and plant materials shall correspond with the approved trees and plant list that corresponds to neighborhood theme and appropriate scale.
- Enhanced walls shall accent the entry process
- Incorporate architectural caps, trims and bases to help delineate architectural detailing.
- Provide accent lighting of landscape/monumentation
- Enhanced paving at the 'B' Street/'D'/'E' Streets (private) intersection not only accentuates the intersection, but also encourages slower vehicular movement and improve pedestrian mobility and safety. This paving shall reflect the overall image of the project.

Method

- Use of focal evergreen trees with a minimum size of 36" box.
- Massing of a variety of a minimum of 5 gallon shrubs and groundcovers in planting beds located at entry points and roadways.
- Secondary entries shall have themed monumentation to enhance arrival experience.
- A mixture of decomposed granite, decorative rock and boulders may be used to create the ground plane within the entry and median:
- A minimum of one five-foot wide sidewalk located on one side of the street shall be provided to allow for pedestrian circulation.
- Stone Veneer finish shall be El Dorado Veneto Field Ledge with standard grout or similar.

- Enhanced paving shall be 80 mm thick Molano Hillstone with rustic “overgrout” application.

Neighborhood Entries

At each of the four corners within the iconic intersection (intersection of ‘B’ Street and private ‘D’/‘E’ Streets) there is an opportunity to provide individual neighborhood “markers” or “signage.” These markers will be the “neighborhood entries” and are designed to be simple pilasters in an Early Rancho theme. Smooth “white wash” stucco columns sit upon rustic stone veneer bases which match the pilasters of the Theme Rail Fence. Within the center of the stucco column there is an opportunity for a builder to “brand” their neighborhood by providing a tile or painted fresco within a provided inset niche. The brand logo or signage should be in the Early California motif. The stucco and cap portion of the pilaster should be consistent at all four columns. The configuration of the stone base may vary depending on site specific grading relationships.



View of Existing Terminus of Indian Ocean Drive



View of Existing Terminus of Biscayne Drive



View of Typical Roundabout

THIS PAGE IS INTENTIONALLY LEFT BLANK.

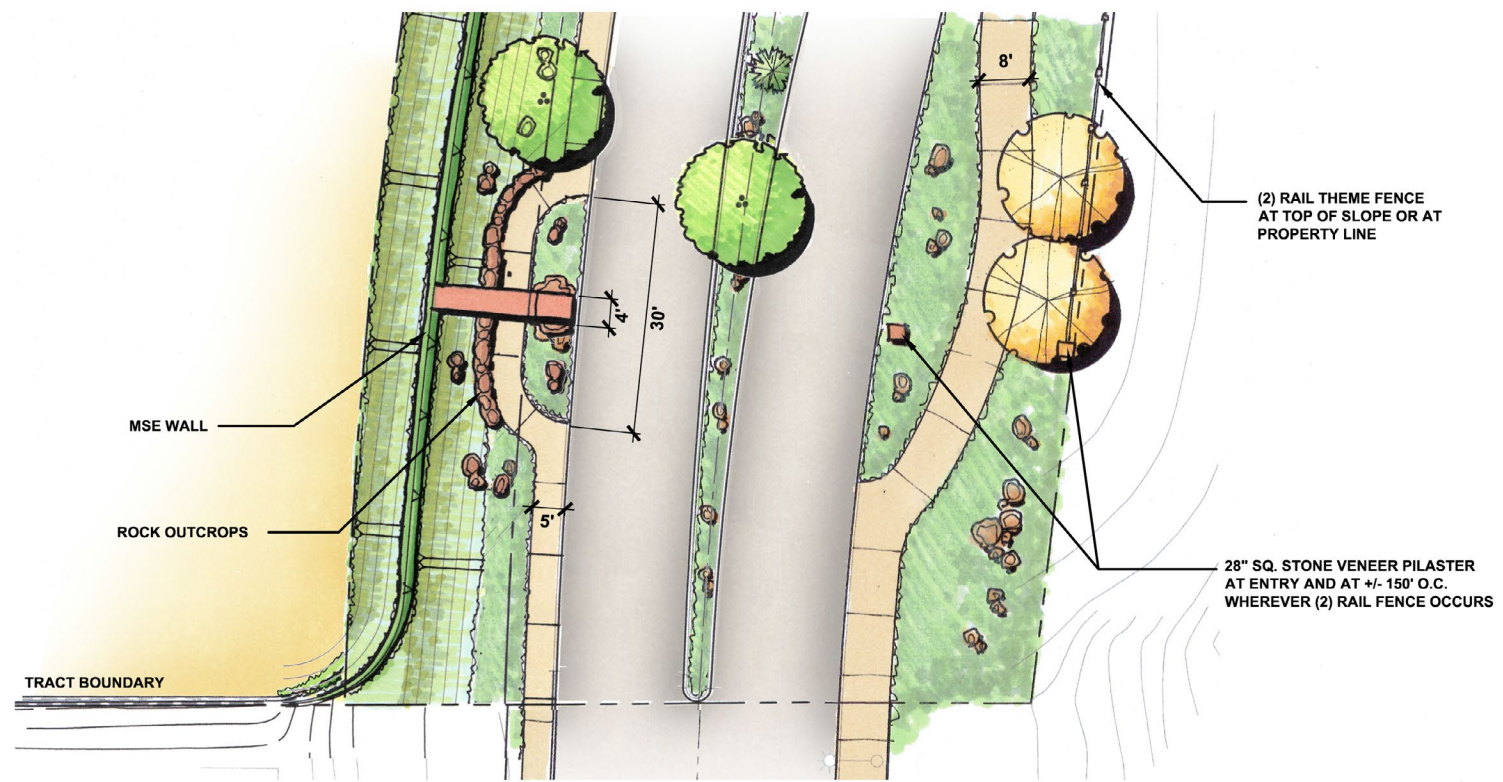

STONE VENEER PILASTER

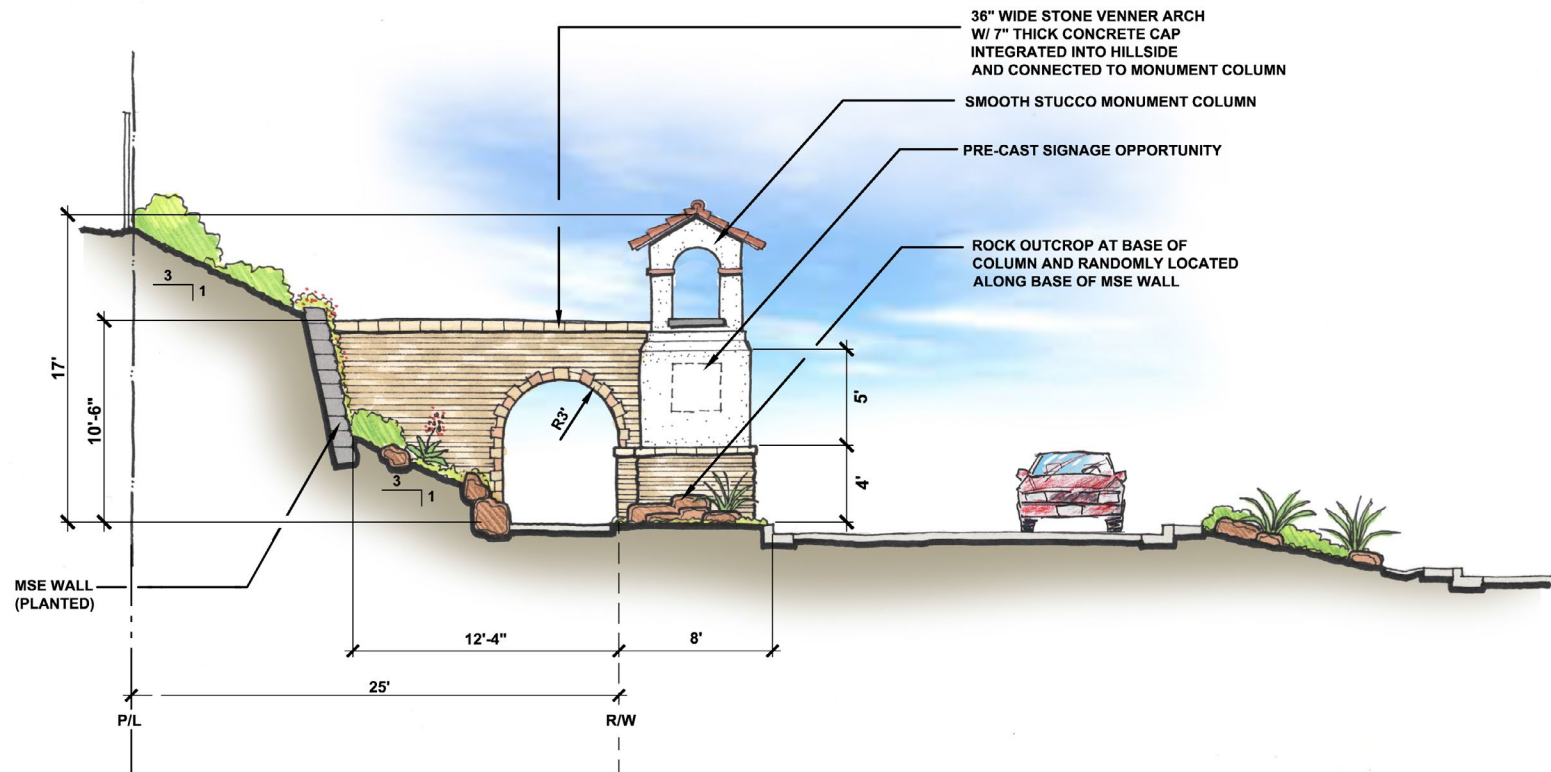

MOLANO HILLSTONE W/ RUSTIC "OVERGROUT" APPLICATION

THIS PAGE IS INTENTIONALLY LEFT BLANK.

COMMUNITY ENTRY & MONUMENTATION AT INDIAN OCEAN DRIVE

EXHIBIT 9-12

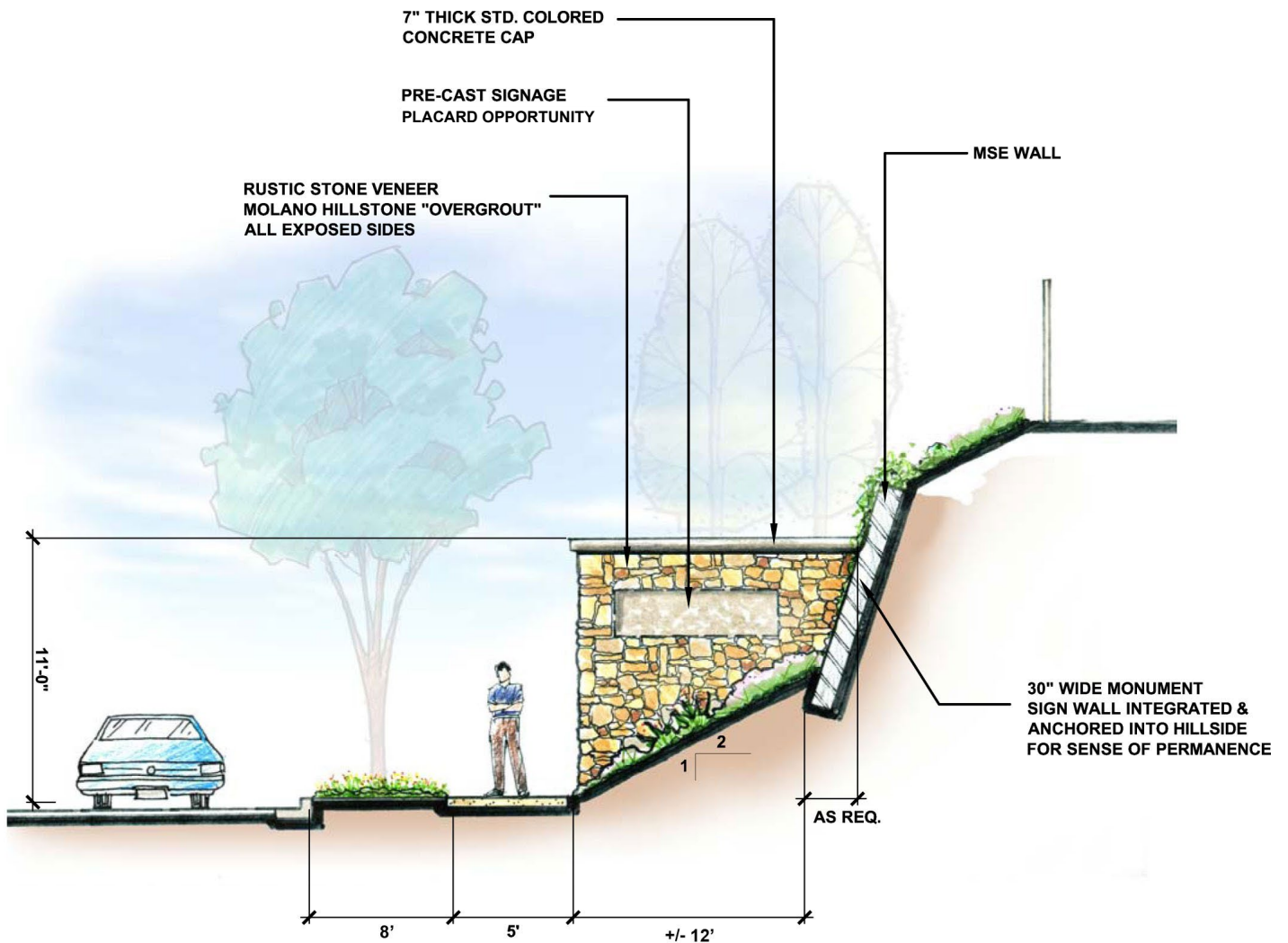

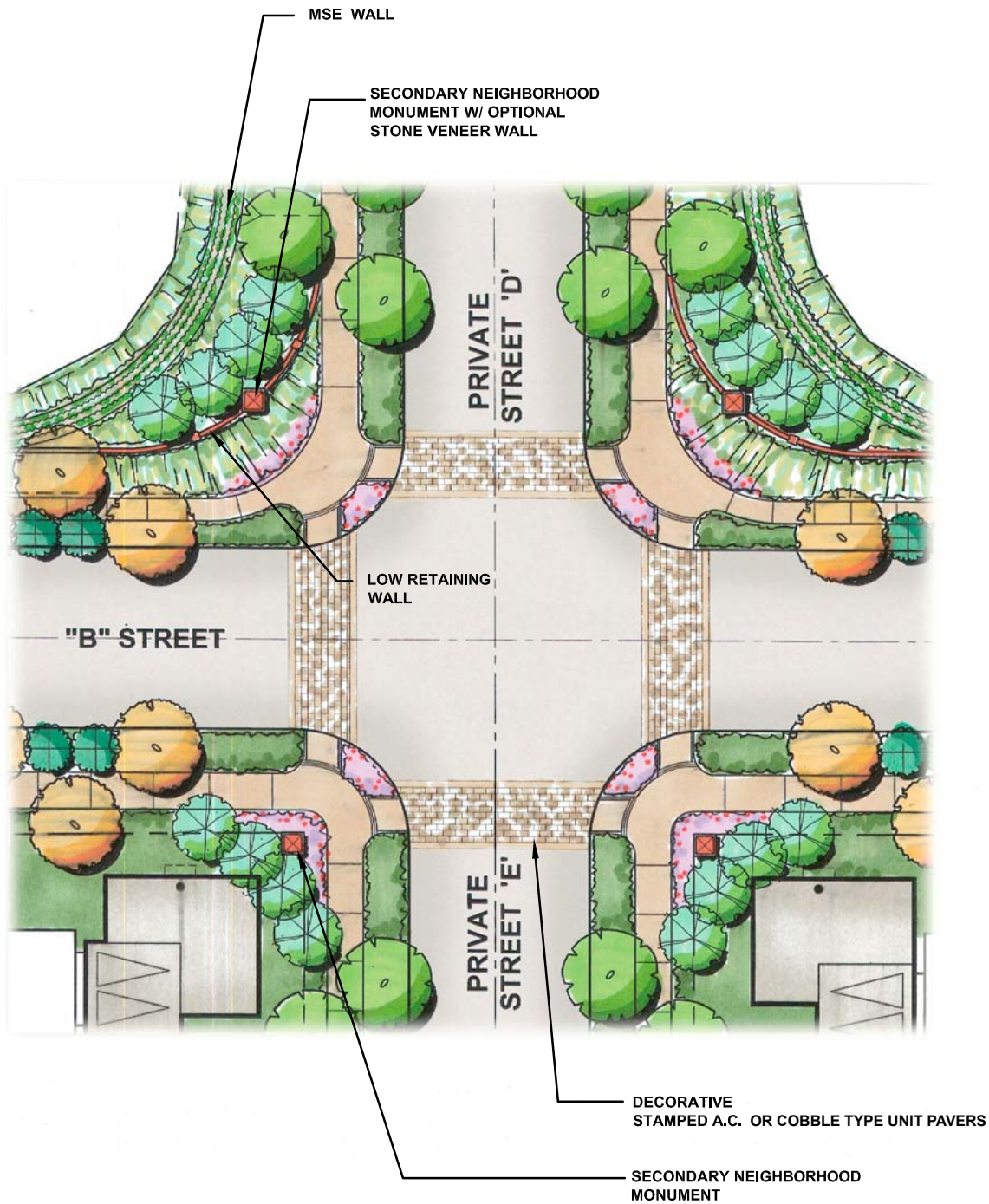

NEIGHBORHOOD ENTRY & MONUMENTATION

EXHIBIT 9-14

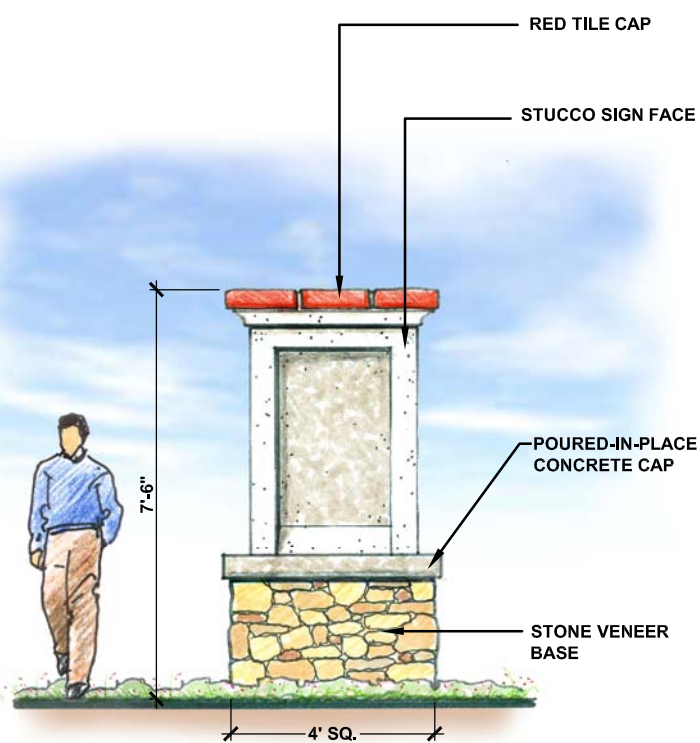
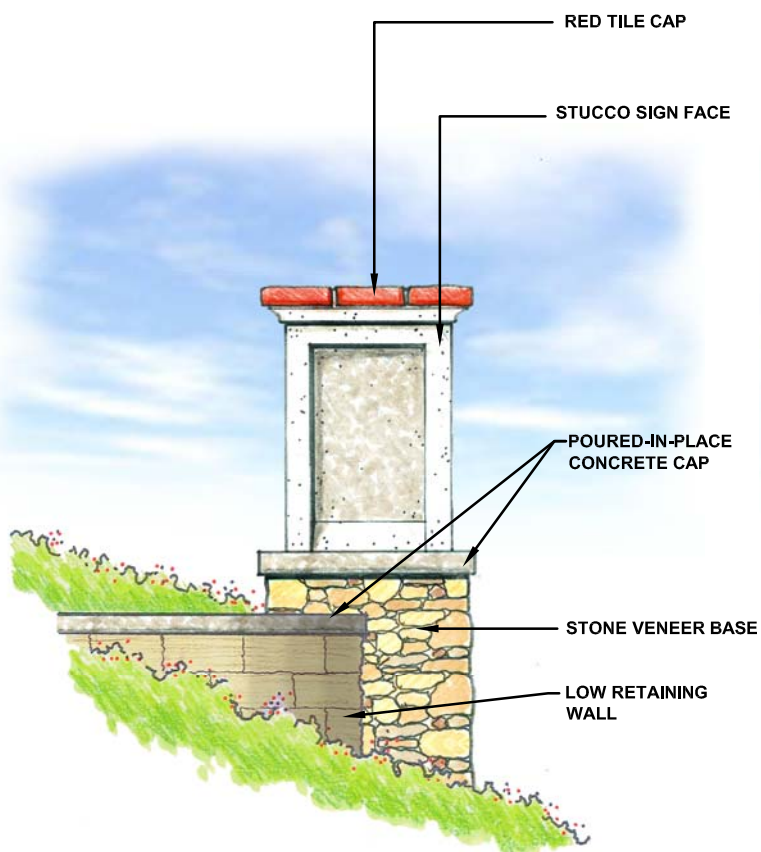
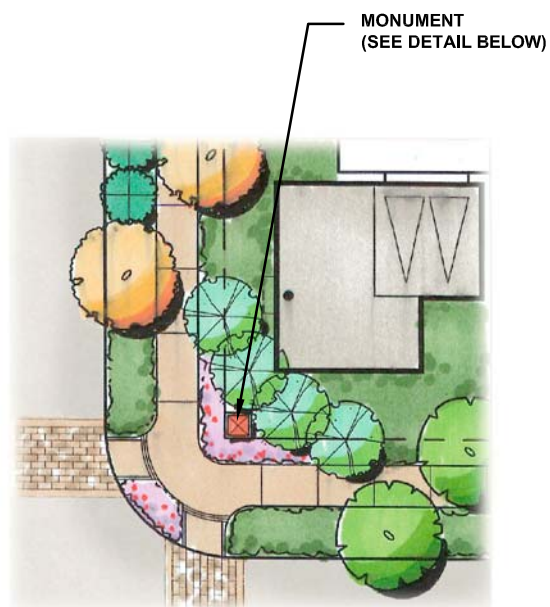
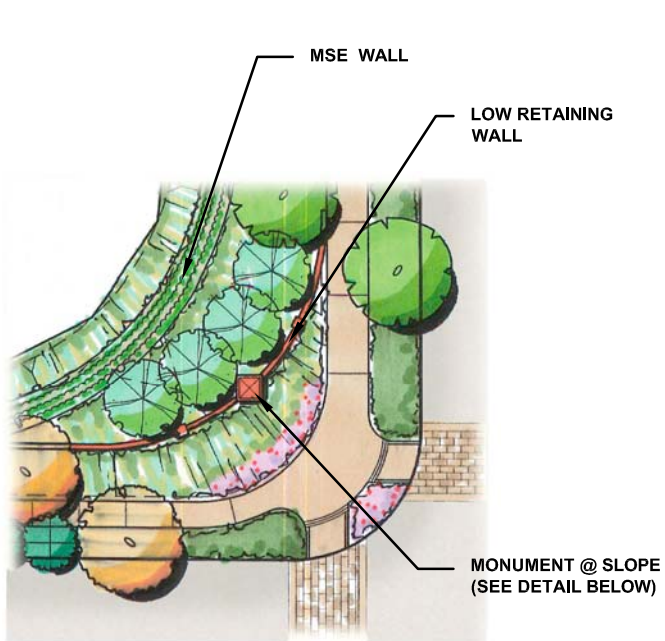

RESIDENTIAL LANDSCAPE DESIGN

9.9

Introduction

Residential landscape design application should bring aspects of the overall community's design theme into the individual neighborhoods. The Area Plan encourages a variety in design to allow each neighborhood its own individual character, while ensuring compatibility with the overall design of the community. The following section addresses these neighborhood design principles.

Neighborhood Design Principles

One of the goals of this section is to enact a process that will create neighborhoods cohesion. This cohesion will allow for connectivity within and between adjoining neighborhoods by addressing the larger, open space areas within a neighborhood in a manner that promotes physical action and social interaction. In addition, this process will address smaller, appropriately scaled and landscaped spaces, which enhance the neighborhood interaction experience at a more intimate level.

The neighborhood component has several key design elements that must be considered in order to achieve the goals that this section sets forth:

- Landscape plantings in public areas should develop a “sense of place” and maintaining harmony within Serrano Summit.
- Size of trees and placement will be appropriate with neighborhood scale. Opportunities for summer shade and sunlight penetration shall be considered.
- Screen and soften undesirable views while promoting and framing more desirable views and vistas that the community has to offer.
- Arrangement of climate-appropriate plants should incorporate the concepts of mass planting; plants should be placed to allow them to grow to their natural sizes and forms, and sheared hedges should be kept to a minimum.
- An overall theme of water conservation shall be represented throughout each neighborhood in the manner that the front yard landscapes are to be designed and maintained.

- Drip irrigation principals are to be used where appropriate
- Refer to the Master Plant Palette (Section 9-14) for exact plant types to be used within Serrano Summit.

Single Family Detached

The landscape design for traditional Single Family Detached neighborhood developments shall serve the purpose of creating a “sense of place” and identity within each development.

The following concepts shall be included:

- Each single-family lot shall be provided with front yard landscaping with a permanent automatic irrigation system. At a minimum, turf or groundcover, appropriate size shrubs and trees shall be provided as landscaping materials. A variety of typical landscape designs shall be provided based upon each building type within the subdivision.
- Landscape and irrigation drawings for each development shall be submitted in conjunction with Site Development Plan or Use Permit for the residential development. These landscape plans should also be reflected on the house construction plans. The plans shall be reviewed by the Planning and Building Departments prior to the issuance of building permits.
- Turf should be planted in functional active areas only.
- The landscape will feature a mixture of trees, shrubs and groundcovers with different shapes, textures and colors that will coordinate with the landscape theme of Serrano Summit.
- Trees shall be planted in informal clusters to create dynamic rhythm and avoid monotony of evenly spaced trees.
- Sizes of trees and placement will be appropriate with neighborhood scale. Opportunities for summer shade and sunlight penetration shall be considered.
- Shrub design and layout should respect the “Tiered Landscape” criteria previously outlined herein.
- Plant accent shrubs to highlight home entries.

Single Family Detached Enclave

The landscape design for the Single Family Detached Enclave developments shall create a unifying element for that neighborhood.

The following concepts shall be included:

- To foster a more dynamic and interesting landscape, the use of specimen trees, unusual clustering, or an accent tree shall be planted at focal points to create “planned surprises” within the neighborhood.
- Open space and common area amenities are encouraged to help promote a sense of community and social interaction within each parcel.
- Typically, Detached Enclave Building layouts can produce landscaped planters of varying sizes. Plants that can thrive in such spaces shall be chosen.
- The location, configuration and quality of the private open spaces for each unit are extremely important. It is highly encouraged to promote natural light penetration into these spaces to increase visibility and livability.
- Planter pockets need to be strategically located throughout the landscape to screen and soften undesirable views as required.
- When deemed necessary to improve the quality of private open space areas, low courtyard walls may be located adjacent to sidewalk or walkways with a landscape buffer.
- The landscape will feature a mixture of trees, shrubbery and groundcovers with different shapes, textures and colors that will tie in with the landscape theme of Serrano Summit.
- Informal tree clustering will be placed on harsh sun exposures for shade and passive cooling during harsh summer days and creating opportunities for people places.
- Shrub design and layout should respect the “Tiered Landscape” criteria previously outlined herein.
- Planting design should help to identify and support common areas, gathering spaces, significant walkway intersections and bring attention to specific areas such as pedestrian crossings at roadways.
- Plant accent shrubs to highlight home entries.

Single Family Attached & Multi-Family Attached

The landscape design for the Single Family Attached and Multi-family Attached developments shall serve the purpose of a unifying element for all that live within that neighborhood.

The following concepts shall be included:

- Open space and common area amenities are encouraged to help promote a sense of community and social interaction within each parcel.
- The site design for both Single Family Attached and Multi-family Attached developments should allow for a hierarchy of landscape open spaces from “large” gathering areas, to “semi-private” open space, to smaller, more “intimate” spaces. The design of each of these types of spaces must be appropriate in scale and function, and reinforce the overall theme.
- Typically Single Family Attached and Multi-Family Attached building layouts can produce landscaped planters of varying sizes. Plants that can thrive in such spaces shall be chosen.
- The location, configuration and quality of the private open spaces for each unit are extremely important. It is highly encouraged to promote natural light penetration into these spaces to increase visibility and livability.
- Planter pockets need to be strategically located throughout the landscape to screen and soften undesirable views as required.
- When deemed necessary to improve the quality of private open space areas, the courtyard walls may be located adjacent to sidewalks or walkways.
- Trees should be strategically located to help mitigate any second floor window to window incursion and screen private open space at the ground level.
- Informal tree clustering will be placed on harsh sun exposures for shade and passive cooling during harsh summer days and creating opportunities for people places.
- Where applicable, tree/plant massing will be planted informally to break the monotonous pattern of equal spacing and create for a more vibrant rhythm.

- Shrub design and layout should reflect the “Tiered Landscape” criteria previously outlined herein.
- Planting design should help to identify and support common areas, gathering spaces, significant walkway intersections and bring attention to specific areas such as pedestrian crossings at roadways.
- Plant accent shrubs to highlight home entries.
- The landscape will feature a mixture of trees, shrubbery and groundcovers with different shapes, textures and colors that will tie in with the landscape theme of Serrano Summit.
- To foster a more dynamic and interesting landscape in Single Family Attached and Multi-family Attached developments, the use of unusual clustering or accent trees shall be planted to create unique elements within the neighborhood

Interior Slope Landscape Design (Where Applicable)

- Construction of interior slope landscape for slopes larger than 5' high shall be the entire responsibility of the parcel developer.
- Soil stabilization is the primary importance of slope plantings, therefore, appropriate deep-rooted and/or fast surface covering plant material is encouraged.
- All trees and plant materials selected shall correspond with the approved trees and plant list to reinforce community theme.
- Trees will be at a minimum size of 15 gallons with required caliper and dimension standards with one tree per 500 square feet of slope area.
- All shrubs shall be a minimum of one gallon in size with one shrub per 36 square feet of slope area.
- Hand planted ground cover shall be planted with a maximum spacing of 18" o.c. or less to ensure 95% slope coverage after 18 months.
- Considerations for permanent hydroseeding, with long-lived plant species within the seed mix, will be considered as an acceptable alternate to hand-planted groundcover material.



Typical Layered Slope Plantings

COMMUNITY TRAIL

9.10

The Community Trail can provide a dual purpose for the residents of Serrano Summit. The community trail is a designed network of landscaped pathways that provides a “walkable” connection for the residents through landscaped areas to the parks, recreation center or Civic Center and open space. It will also connect with the Serrano Creek Regional Trail.

The following concepts shall be included:

- The trail provides for small gathering spaces encouraging opportunities for social interaction among neighbors, and promotes a healthy community.
- The trail will have pathways running alongside an aesthetic landscape; dotted with an assortment of trees and a variety of shrubs, groundcovers and rockscape creating for a more sensory, walk-through experience.
- The trail will have a block wall for site enclosure when adjacent to resident’s property.
- Signage shall be easily visible and be harmonious with the community theme design.
- A variety of canopy trees shall be strategically located to provide a “shade oasis” at specific intervals and seating node locations to add comfort for pedestrians using the trail.

Sidewalks within Serrano Summit will vary in width from 5’ minimum (along Indian Ocean Drive) to 8’ (along ‘A’ Street, ‘B’ Street, and private ‘D’ and ‘E’ Streets). The multi-purpose trail between the Civic Center and Passive Park will be constructed as an approximately 20 foot wide all-weather access. Trails may be constructed of a variety of materials including, but not limited to, concrete and/or decomposed granite.



Formal Walkway

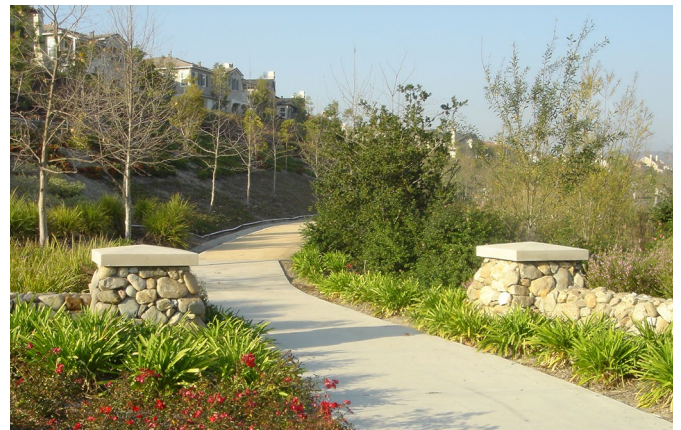

Nature Trail



Decomposed Granite Pathway

NEIGHBORHOOD PARKS

9.11

Neighborhood parks present an opportunity for shared recreation and sports between neighbors for Serrano Summit, thereby fostering relationships and building a healthy community. The landscape design allocates spaces for these activities where passive and active recreation come together.

Modern park design encourages visibility to the parks, causing their associated activities to become an integral part of the community fabric. This visibility makes it easy for nearby residents to look into park activities and conduct frequent surveillance of the park as part of the everyday fabric of their lifestyle. These design features, designed to connect residents, will promote public safety and security, as well as minimize park vandalism.

There shall be a distinct edge created between private property and any city-owned parkland. This edge shall consist of a landscape buffer, street or alleyway, or other separation acceptable to the City of Lake Forest. In addition, walkways to individual dwelling units shall be separate from park walkways.

In addition, neighborhood parks shall be designed to enhance the comfort of those using the facilities. For example, the following concepts are encouraged:

- Overhead structures such as trellises, arbors, archways shall have opportunities for shade. Their design shall tie in with the community's character and theme.
- Site furnishings such as picnic tables, barbecues, benches, waste receptacles and other site amenities in a consistent design in accordance with the Serrano Summit theme
- Signage shall be easily visible and be harmonious with the community theme design.
- All trees and plant materials selected will correspond with the approved trees and plant list to reinforce the community theme.
- Trees will be a minimum of 15 gallon size to provide opportunities for shade and seasonal change for accenting.
- Massing of shrubbery is encouraged along the perimeter of the wall or slope.
- One required handicap parking space per park (applies to Planning Areas 15 and 16) shall be provided, on or off-site. Street parking is acceptable. The Serrano Summit community is

designed to encourage residents to walk and bike to the parks using the sidewalks, paseos and trail on-site. On-street parking for parks will be provided.

Pursuant to the Development Agreement, the neighborhood parks in Planning Areas 15 and 16 will include the following:

- Minimum Improvements:
 - ~ Construction water, WQMP, BMPs
 - ~ Temporary utilities
 - ~ Site grading, rough
 - ~ Site grading, fine
 - ~ Site drainage
 - ~ Utility connections
 - ~ Hardscape, sidewalks, minimum 5' wide, concrete
 - ~ Hardscape, mow-strip, concrete
 - ~ Turf, sod
 - ~ Shrubs, minimum 5 gallon size
 - ~ Trees, minimum 15 gallon size
 - ~ Mulch/soil preparation
 - ~ Automatic irrigation systems with computer and communications
 - ~ Automatic security lighting system with communications
 - ~ ADA universal signage
 - ~ City standard park identification sign and park rules sign
 - ~ ADA accessible path of travel
 - ~ Concrete pavement under tables and seating
 - ~ Athletic field and/or courts
 - ~ 1 Tennis court, volleyball court or basketball court
 - ~ Spectator seating
 - ~ Tables, benches, trash cans, drinking fountains and barbecues
 - 1 Group barbecue with 4 tables or 2 family barbecues with 2 tables per barbecue
 - 1 Drinking fountain per field, court and picnic area
 - ~ Play lots appropriate by age group
 - 1 Tot area
 - 1 adjacent bench

Pursuant to the Development Agreement, the passive/nature park in Planning Area 17 will include the following:

- Minimum Improvements:

NEIGHBORHOOD PARK DESIGN (PLANNING AREA 15)

EXHIBIT 9-15

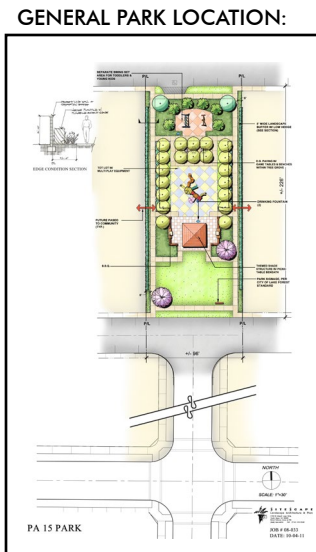
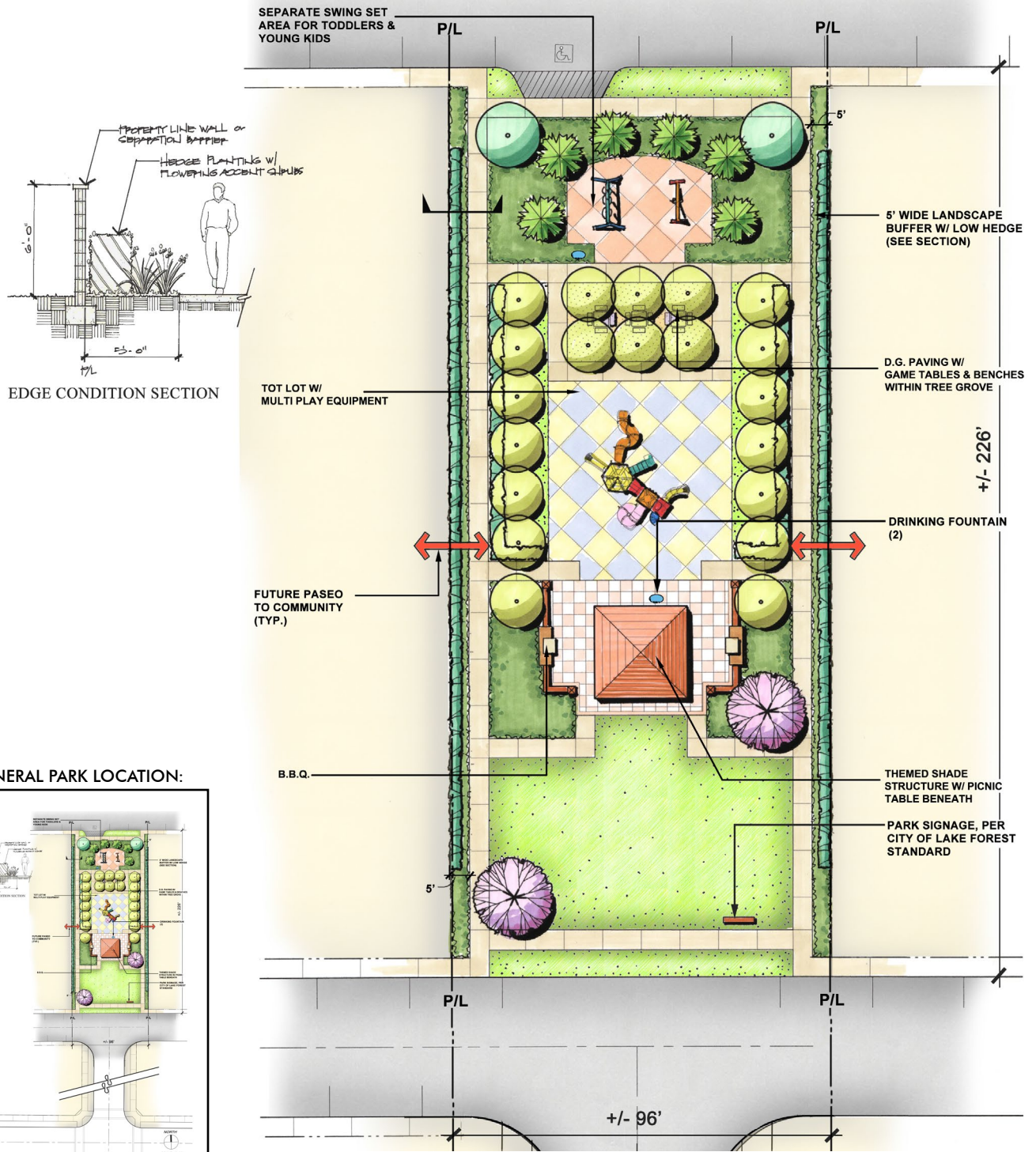

This exhibit is provided as the Precise Design.

NEIGHBORHOOD PARK DESIGN (PLANNING AREA 16)

EXHIBIT 9-16

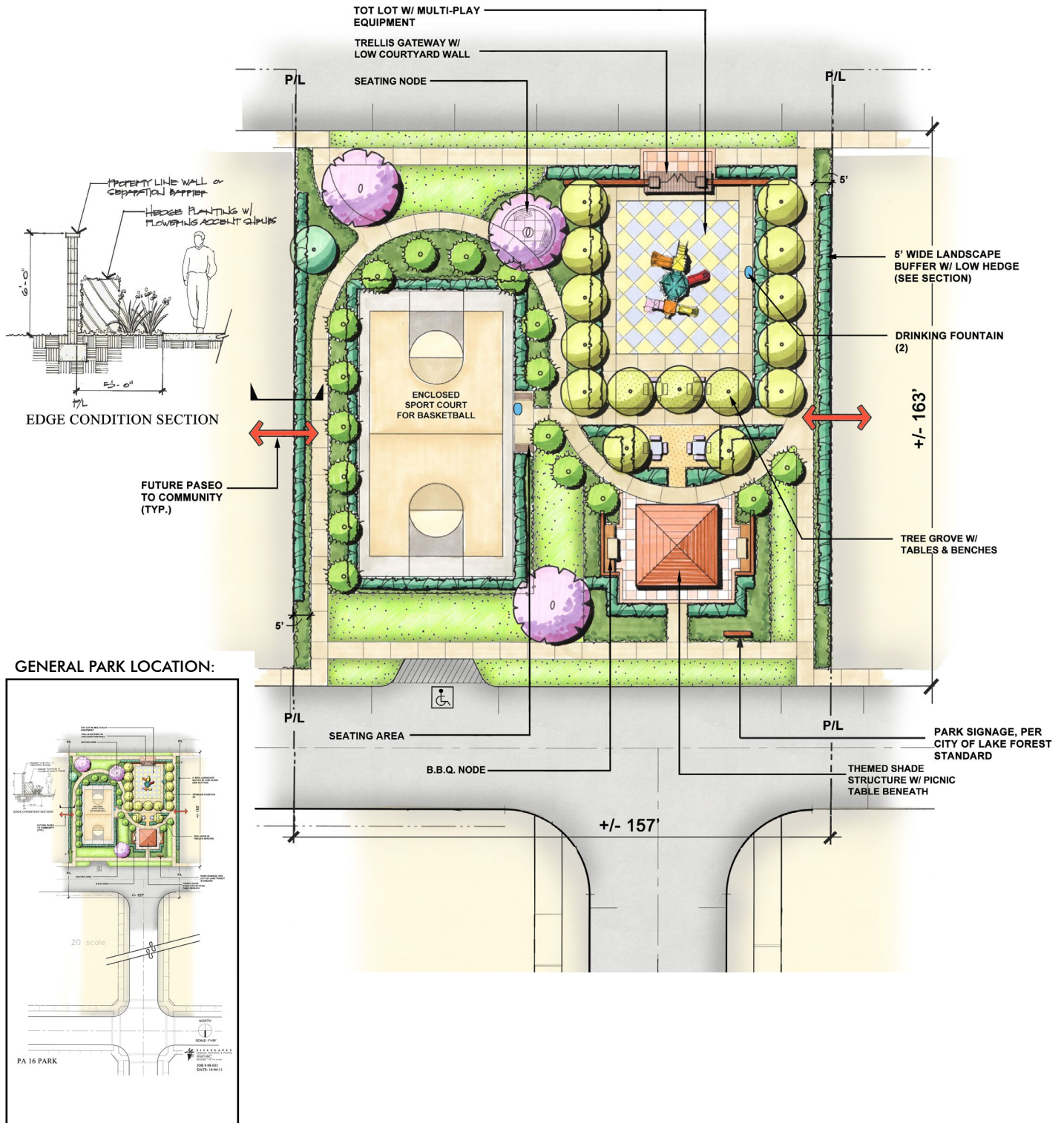

This exhibit is provided as the Precise Design.

PASSIVE / NATURE PARK DESIGN (PLANNING AREA 17)

EXHIBIT 9-17



This exhibit is provided as the Precise Design.

SERRANO SUMMIT AREA PLAN

- ~ Construction water, WQMP, BMPs
- ~ Temporary utilities
- ~ Site grading, rough
- ~ Site grading, fine
- ~ Site drainage
- ~ Utility connections
- ~ Walkways/paths, minimum 5' wide, decomposed granite
- ~ Hardscape, mow-strip, concrete
- ~ Turf, sod
- ~ Shrubs, minimum 5 gallon size
- ~ Trees, minimum 15 gallon size
- ~ Mulch/soil preparation
- ~ Automatic irrigation systems with computer and communications
- ~ Automatic security lighting system with communications
- ~ ADA universal signage
- ~ City standard park identification sign and park rules sign
- ~ ADA accessible path of travel
- ~ Concrete pavement under tables and seating
- ~ Tables, benches, trash cans, drinking fountains and barbecues
 - 1 Group barbecue with 4 tables or 2 family barbecues with 2 tables per barbecue
 - 1 Drinking fountain
- ~ 1 Shade structure for group recreation purposes, minimum 50%
- ~ Hitching posts
- ~ Watering trough

For the passive/nature park, the following criteria will apply to the area credited for parkland:

- Must be open to all Lake Forest residents, not restricted to any private use
- Minimum core dimensions of 200' x 200'
- Utilize natural topography as much as possible
- No slopes greater than 6:1
- There shall be no grade differences over 30 inches

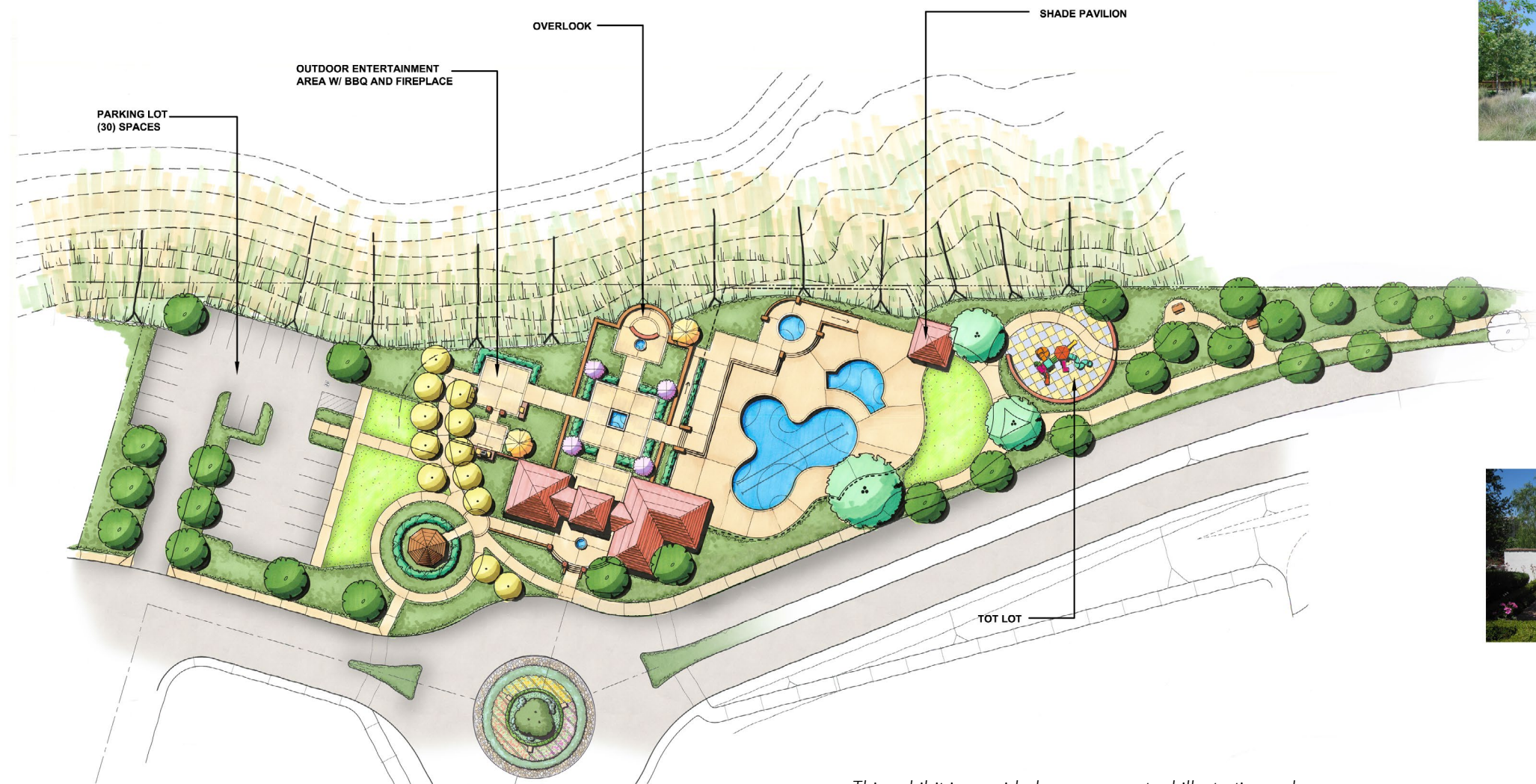

This exhibit is provided as a conceptual illustration only.



THIS PAGE IS INTENTIONALLY LEFT BLANK.

Lighting within Serrano Summit shall be consistent in style, color, and materials in order to maintain uniformity throughout. Lighting should be subtle, providing a soft wash of light over illuminated objects such as monumentation. A hierarchy shall be established by using a variety of lighting fixtures of appropriate illumination levels. Lighting styles shall tie into architectural styles and provide sufficient illumination for the safety and well being of the community. Fixture locations should be designed so that light source is not unnecessarily visible by pedestrian or vehicular traffic. Lighting shall be designed to prevent glare from impacting the adjacent residential areas. Frosted, louvered, or prismatic lens should be considered where decorative lighting fixtures are visible and part of the aesthetic lighting program.

The City shall maintain street lights on all public streets within Serrano Summit. The developer will submit specific lighting designs describing the type, style and height of lighting along with designs for streets and parks to the City for review and approval with the Final A Map and infrastructure construction drawings.



WALLS & FENCES

9.13

Within Serrano Summit, the walls and fences are a major component in achieving an overall community theme. A strong cohesive appearance for the community is achieved through the use of a themed community wall program and general overall wall guidelines (see Exhibit 9-19).

Exterior wall colors shall harmonize with the site. Textures are to be integrated with the site to produce a variety of shade and texture.

Wall design, materials, color and finishes shall complement adjacent architecture to keep the community design theme cohesive.

All walls that adjoin community streets (major streetscapes identified under Community- and Neighborhood-Level Streetscapes) shall be deemed “community walls.” The other walls and fencing, known as “product walls” and “View Fences” shall also adhere to the strict guidelines within.

Community Walls

Community walls shall be decorative in nature. These walls consist of either solid walls, view fences, or a combination of the two.

Solid community walls shall be constructed of concrete masonry unit (CMU) block. The exterior face of the CMU community walls shall either be decorative concrete block, painted stucco or integral color stucco on concrete block.

View fences or view walls along community open spaces are encouraged wherever privacy or screening is not necessary. These shall be constructed to conform to the “View Fences” community standard.

Community walls shall incorporate the use of pilasters or other design elements to help break up long stretches of walls and provide interest and rhythm. Pilaster design should compliment, or be consistent with, the materials of the community walls.

Theme Rail Fence with Pilasters

The use of a two rail fence with low stone veneer pilasters will compliment the Early California Rancho theme and will provide a rustic, established element to the community. These Themed Rail Fences will be present immediately upon entry to the community and are designed to work together with the entry monumentation. The open rail fence is located at the top of slopes to preserve and frame views or as safety guardrail adjacent to pedestrian walkways. The rail fence should have a weathered, aged appearance and be constructed of concrete, wood or vinyl.

Stone veneer pilasters should be located along fence’s major turning points and at the ends. A stone veneer of rustic, natural appearance in organic, earth toned hues is required. A precast plaque or medallion should be added to some key pilasters, similar to

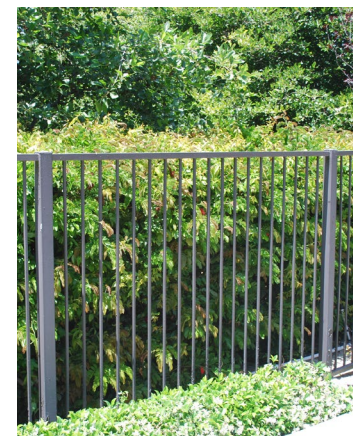

style in which Early California Rancho branded. This plaque should be integral with the pilaster to avoid a “bolted on” appearance. (See Exhibit 9-20)

Masonry Walls

- Masonry product walls are all walls interior to a project that are not community walls and are built by the parcel developer; they shall develop a unified parcel wall theme that reflects the theme of the community.
- Masonry product walls are visible from adjacent non-residential parcels, streets or community open space.
- Side yard wall returns, side yard privacy walls along corner lots, and rear yard privacy walls along neighborhood streets are all masonry walls.
- All masonry product walls shall be constructed of CMU block and shall be installed on individual lots within all neighborhoods including side yard wall returns, side yard privacy walls along corner lots, and rear yard privacy walls along neighborhood streets. The exterior face of the product CMU walls shall either be decorative concrete block, painted stucco or integral color stucco on concrete block.
- All walls built by the parcel developer within or at the perimeter of single family neighborhoods shall meet County/City pool safety requirements.
- Where two masonry walls meet at adjoining parcels, walls shall match in color and finish, or have a unifying transitional element such as a pilaster at the connection point.
- Walls shall have a maximum step of 16 inches with a minimum of 32 inches horizontal between steps.

Retaining Wall System

Wall systems referred to as Mechanically Stabilized Earth (MSE) will be used within the community where slopes, topography differences, and/or design considerations warrant the use of a retaining wall system. This type of wall will only be used interior to the community and not on the community edges. Every effort will be taken to comply with the Retaining Wall Design Guidelines of the City. The MSE system will primarily be used along the main collector streets A, B, and Indian Ocean, with smaller MSE systems used along internal paseos and private streets. Several elements of the Guidelines will be used to soften the internal impacts of the walls on local

residents as they travel along the collector streets. The wall itself will be planted using the soil pockets throughout the wall system. These vine-type plants will transform the walls into “green” backgrounds. The top of the walls will be lower than the building pad above, thus creating a slope bank at the top of the wall that will be planted to soften that upper edge and reduce the height of the wall. Significant setbacks will be provided from the base of the wall to the street. Allowing adequate space to provide this landscaping screen is important to diminishing any visual impacts of the wall. On collector streets where the wall will be used, the distance between the curb and the base of the wall will be a minimum of 20 feet and in many locations will be more than 20 feet. Within this setback there will be a series of canopy trees and shrubs that will draw the passerby attention to the foliage and diminish the visibility of the wall. The parkway will have a double row of canopy trees on either side of the sidewalk, staggered in order to provide maximum “shielding” of the wall from both drivers and pedestrians. At certain key intersections the wall system will be split, providing for a stepped system of two walls rather than one. To further diminish any impact of the wall, it will vary in setback horizontally and will vary in vertical height in order to limit the look of a monolithic wall. The entire system of MSE walls and surrounding parkway and slope bank landscaping will be maintained by the Homeowner’s Association.

HEIGHT/DISTANCE CHART

LOCATION	HEIGHT OF WALL	DISTANCE
A Street	+ 6'	12.5'
B Street	6' & 14' (double wall)	14'
Indian Ocean	+ 8.5'	17'



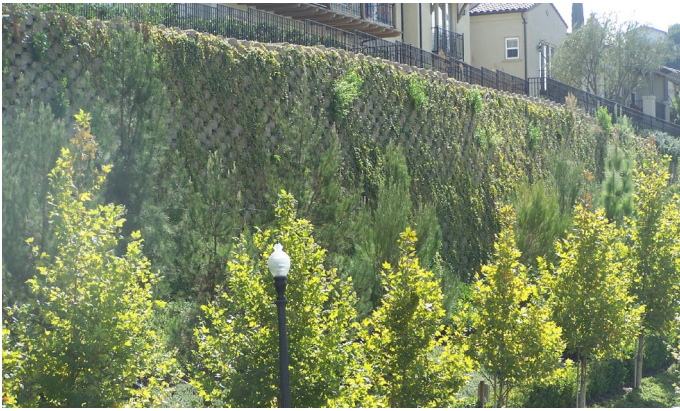

View Fences

If applicable, view fences should be located in the rear or side yards of those properties abutting open space areas or have off-site views. These fences allow open views outward but not physical access; they shall be 5'-6" min. high. View fences may be constructed of tubular steel or lexan glass panel construction or plexiglass and vinyl or 5'-6" min. combination wall (2' CMU block wall with 4' tubular steel fence). The use of view fences shall incorporate pilasters utilizing materials consistent with adjacent walls.

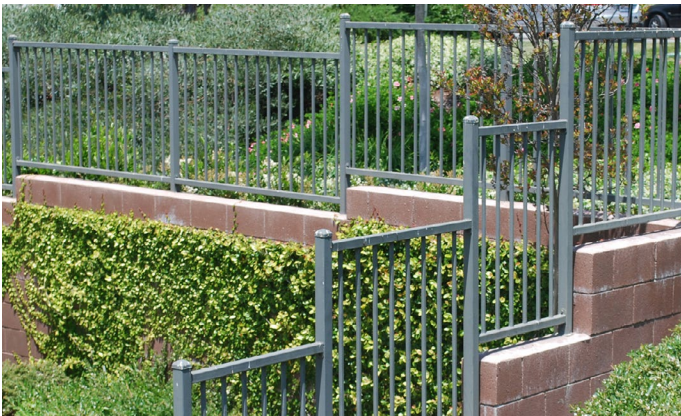

All view walls built by the parcel developer within or at the perimeter of single family neighborhoods shall comply with the "View Fences" community standard design.

Garden Walls

Garden walls or fences shall not exceed 42 inches in height and may be constructed of CMU block or with materials that match the architectural style of the home. Walls to be located a minimum of two feet (2') from back of adjacent walk.

Retaining Garden and Landscape Walls

- Retaining walls next to or visible from any street or community open space shall not exceed three feet (3') in height. Grade changes that require more retaining must be terraced with a minimum three foot (3') wide planter as measured from face of wall to face of wall, unless a crib wall is used.
- Independent retaining walls must be set back a minimum of two feet (2') from back of sidewalk. Retaining walls shall not abut a sidewalk, but may abut utility boxes. All independent retaining walls must have a return back to the adjacent product wall or taper to one block high at end of retaining condition.
- Retaining walls may be combined with a product or community wall as long as the total visible height of the solid wall surface, as measured on the exterior side of the wall, does not exceed 8 feet and is softened by landscape.
- Retaining walls interior to a parcel, but visible from any street or community open space shall be splitface or crib style.

THIS PAGE IS INTENTIONALLY LEFT BLANK.

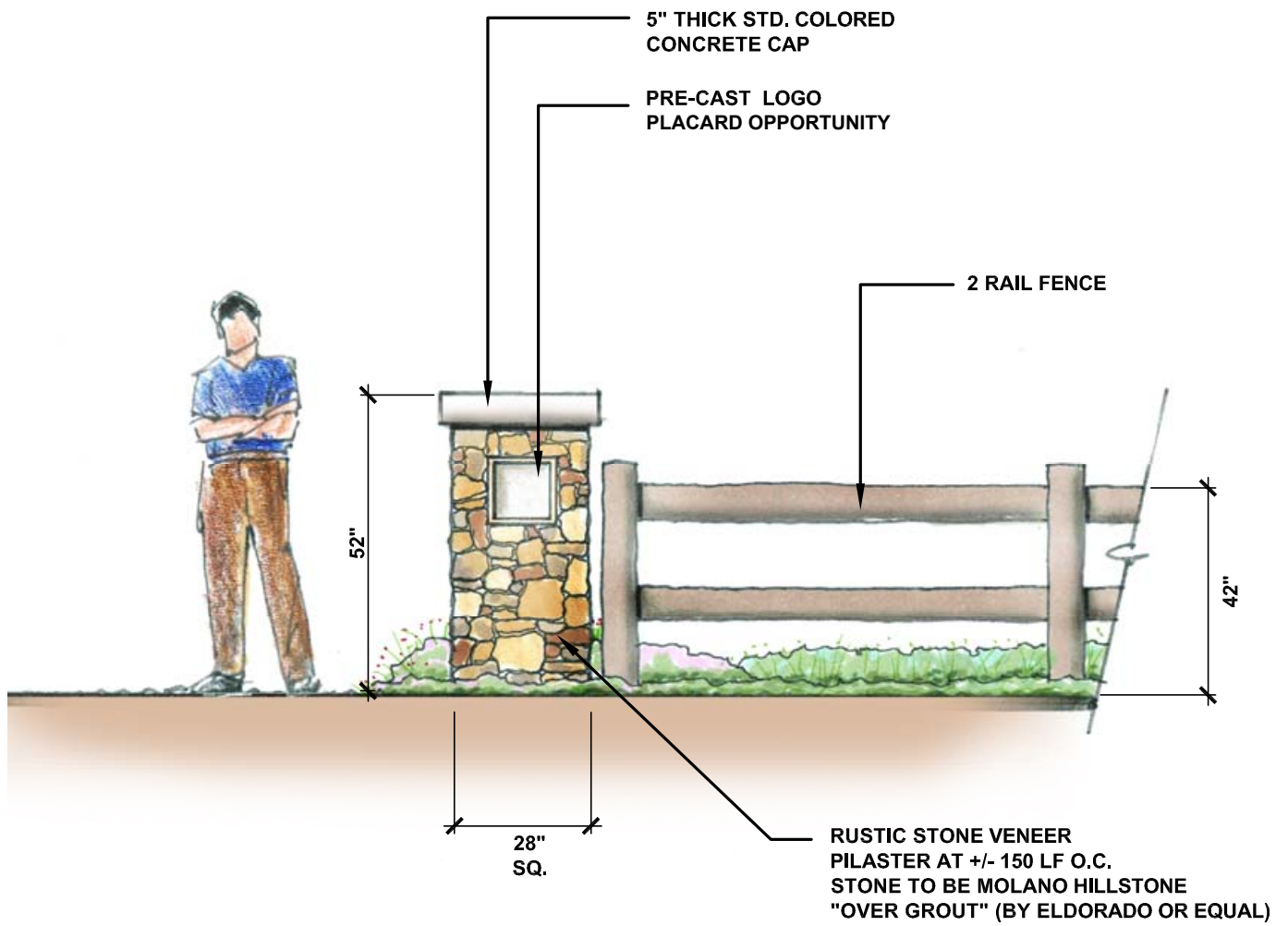

SITE FURNITURE

9.14

The design of street furniture such as street lighting, trash receptacles, benches, bollards, posts, signage markers and others shall be inspired by the community theme to provide consistency and connectivity with surrounding neighborhoods and harmonize with the community's design theme.

Colors and materials of street furniture shall complement the surrounding natural hillside terrain and landscape and shall be consistent with the rustic California community theme community landscape.

SITE FURNITURE (Typical Examples)



Bench



Rectangular Picnic Table



Square Picnic Table



Waste Container



Bench



Rectangular Picnic Table



Square Picnic Table



Waste Container

SITE FURNITURE - UNIVERSAL (Typical Examples)



Bike Rack



Bollard

FUEL MODIFICATION

9.15

As an infill project with minor areas of open space, the Serrano Summit fire safety aspects have been designed and will be protected using the most recently developed codes. BehavePlus was used to estimate the maximum intensity of a fire moving towards this development, including flame lengths and fire intensity. The fuel modification zones were designed and located to cope with these findings and will ultimately reduce the flame lengths and fire intensity by the installation and maintenance of the Fuel Modification and Fire Master Plans.

Using a systematic approach, the threats presented by the vegetation that will remain after the completion of this project have been mitigated to a point where they do not present a risk to the structures or occupants of this project. The usage of fuel modification, enhanced construction features (where called for), and ongoing maintenance of the fuel modification zone, will insure that this community remains protected from the threat of wildfires as long as the conditions required by this program are in compliance.

THIS PAGE IS INTENTIONALLY LEFT BLANK.

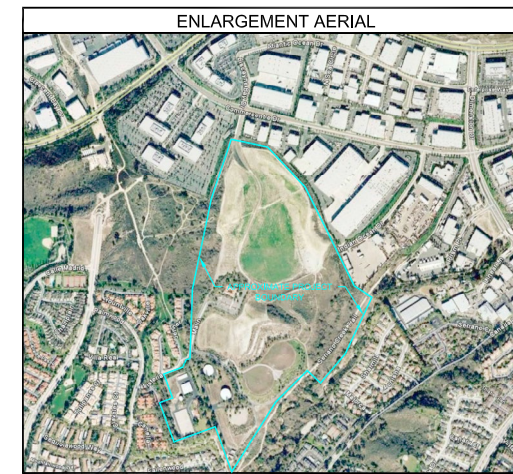
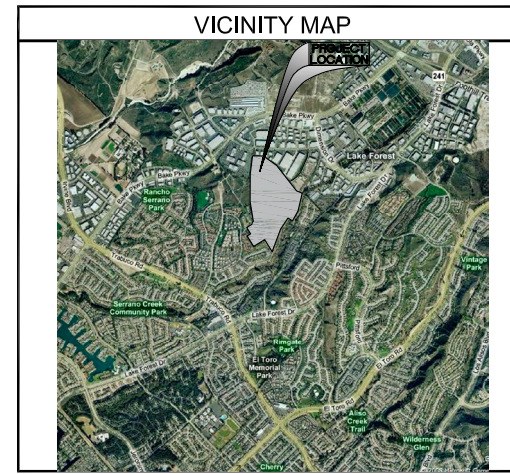
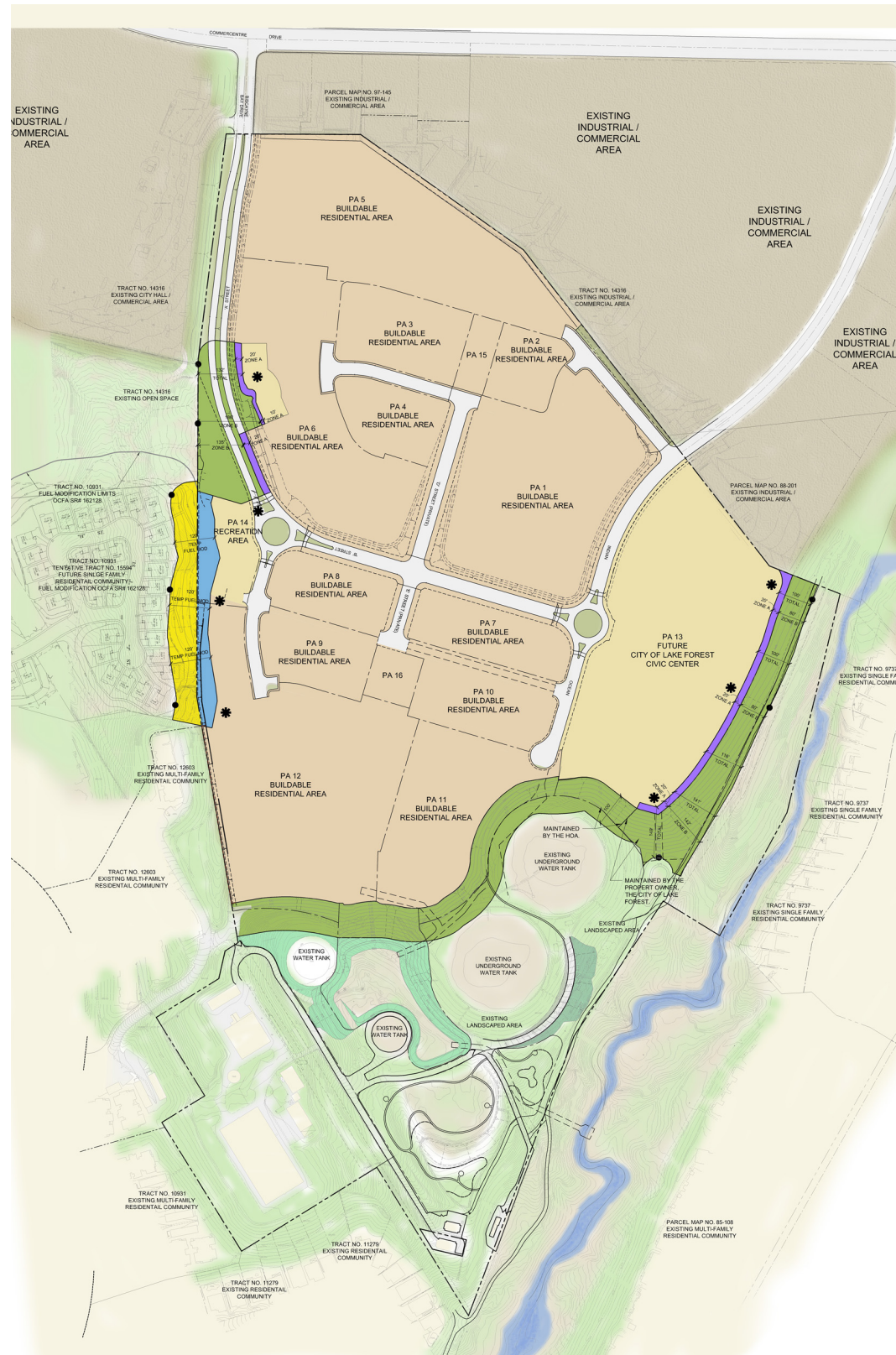

SYMBOL LEGEND

	ACCESS POINT - FUEL MODIFICATION WALK IN ACCESS POINT (A 5' NON-COMBUSTIBLE TUBULAR STEEL GATE WILL ONLY BE PROVIDED WHERE NECESSARY). 500' MINIMUM DISTANCE BETWEEN ACCESS POINTS AT FUEL MODIFICATION.
	IDENTIFICATION MARKER - PERMANENT IDENTIFICATION MARKERS SHALL BE CONSTRUCTED TO IDENTIFY THE LIMITS OF APPLICABLE FUEL MODIFICATION ZONES. MARKER DESIGN SHALL BE 2" DIA. X 8'-0" LONG GALVANIZED PIPE. EMBED MINIMUM 2'-6" INTO SOLID GROUND. STENCIL TOP 6" WITH A LETTER 'B' OR 'Z'. EXPOSE PIPE 2'-0" ABOVE VEGETATION MINIMUM.

FUEL MODIFICATION LEGEND

	FUEL MODIFICATION ZONE A - 10' to 20' minimum flat or level grade - Beginning of Fuel Modification. Non-combustible construction within this zone only. Maintained by the Property Owner and or the HOA. Fuel Modification consists of irrigated landscape with plant material from the OCFA Fuel Modification Plant Palette only. Refer to Fuel Modification Requirements and Maintenance Notes. No plant material from the Undesirable Plant List shall be allowed within this zone.
	FUEL MODIFICATION ZONE B - 80' to 186' - Maintained by HOA. Fuel Modification consists of irrigated landscape with plant material from the approved OCFA Fuel Modification Plant List. Zone B will be a minimum of 80' in a portion of the fuel modification. Refer to Fuel Modification Requirements and Maintenance Notes. No plant material from the Undesirable Plant List shall be allowed within this zone.
	TEMPORARY FUEL MODIFICATION ZONE B - 32' to 67' - Maintained by HOA. Fuel Modification consists of irrigated landscape with plant material from the approved OCFA Fuel Modification Plant List. Zone B will be a minimum of 32' in a portion of the fuel modification. Refer to Fuel Modification Requirements and Maintenance Notes. No plant material from the Undesirable Plant List shall be allowed within this zone. This zone shall be installed prior to construction of Planning Area X only if this project (tract#) begins construction prior to the adjoining project (tract#) per the license agreement agreed upon by both parties.
	TEMPORARY FUEL MODIFICATION & WEED ABATEMENT - 53' - 88' - Maintained by HOA. Temporary Fuel Modification consists of a 50% Zone C which will be a minimum of 53' throughout. Refer to Fuel Modification Requirements and Maintenance Notes, Section Zone C. No plant material from the Undesirable Plant List shall be allowed within this zone.
	MANUFACTURED SLOPE IN THE VICINITY OF THE FUEL MODIFICATION Landscaped and irrigated areas as shown on this plan maintained by the HOA and/or property owner. Plant material must comply with OCFA Attachment 8: Fuel Modification Zone Plant List.

BUILDING CONSTRUCTION CLASSIFICATION LEGEND

	ENHANCED CONSTRUCTION ZONE - STRUCTURES ADJOINING THE FUEL MODIFICATION: All structures within PA 13, PA 14, and structures adjoining the fuel modification on PA 6 as depicted on this plan shall receive "enhanced construction" on all four (4) sides per 2007 California Building Code Chapter 7A. Chapter 7A amendments require vents to be a minimum of $\frac{1}{8}$ " and a maximum of $\frac{1}{4}$ ", however we are providing a maximum of $\frac{1}{8}$ " venting.
	All other structures within this project shall meet roofing and venting requirements of the 2007 California Building Code Chapter 7A. Chapter 7A amendments require vents to be a minimum of $\frac{1}{8}$ " and a maximum of $\frac{1}{4}$ ", however we are providing a maximum of $\frac{1}{8}$ " venting.

All structures within this project shall be protected with Automatic Fire Sprinklers as follows:

- All Single Family and Duplex structures shall be protected with NFPA 13-D.
- All Multi-family structures shall be protected with NFPA 13-R.
- All Commercial structures shall be protected with full NFPA 13.



THIS PAGE IS INTENTIONALLY LEFT BLANK.

MASTER PLANT PALETTE

9.16

TABLE 9-4
MASTER PLANT PALETTE

BOTANICAL NAME	COMMON NAME	ACCENT	VERTICAL SCREEN/ BACKGROUND	STREET TREE	UNDERSTORY TREE	PARKS & TRAILS	RIPARIAN ZONE	CONIFEROUS FOREST	CALIFORNIA/HILLSIDE FRIENDLY ZONE	FUEL MOD SLOPES
TREES										
Acacia smallii	Sweet Acacia								•	
Alnus rhombifolia	White Alder		•					•		•
Arbutus 'Marina'	Strawberry Tree				•					
Callistemon viminalis	Weeping Bottle Brush		•						•	
Cedrus deodara	Deodar Cedar					•		•		
Cercis mexicana	Mexican Redbud				•					•
Cercidium h. 'Desert Museum'	Thornless Hybrid Palo V.								•	
Chitalpa tashkentensis 'Pink Dawn'	Chitalpa				•	•				
Cinnamomum camphora	Camphor Tree	•		•						
Cupaniopsis anacardioides	Carrotwood			•			•			
Cupressus sempervirens	Italian Cypress	•								
Dracaena draco	Dragon Tree	•								
Heteromeles arbutifolia	Toyon	•								•
Lagerstroemia farnesia 'Hybrid'	Crape Myrtle	•		•				•	•	
Lyonothamnus floribundus	Catalina Ironwood				•					
Magnolia grandiflora 'D.D. Blanchard'	Southern Magnolia		•	•				•		
Melaleuca quinquenervia	Cajeput Tree		•	•			•			
Pinus canariensis	Canary Island Pine		•	•				•		
Pinus eldarica	Afghan Pine		•	•				•		
Pinus pinea	Italian Stone Pine			•				•		
Platanus acerifolia 'Bloodgood'	London Plane Tree		•	•		•			•	
Platanus racemosa (1)	California Sycamore		•	•			•			•
Prosopis glandulosa 'Thornless'	Thornless Texas Honey Mesquite	•							•	
Pyrus calleryana 'Aristocrat'	Aristocrat Flowering Pear	•				•				
Quercus agrifolia (1)	Coast Live Oak			•		•	•		•	•
Quercus douglasii (1)	Blue Oak									•
Rhus lancea	African Sumac			•					•	•
Sambucus Mexicana	Mexican Elderberry								•	•
*Schinus molle	California Pepper Tree			•		•				
Tipuana tipu	Tipu Tree			•						
*Tristania conferta	Brisbane Box		•	•		•		•		
Ulmus parvifolia 'True Green'	Evergreen Elm	•				•				
Umbellularia californica (1)	California Bay			•			•			
Zelkova serrata 'Halka'	Sawleaf Zelkova					•				

(*) Denotes trees that are to be avoided in wind prone areas
(1) Denotes trees that are native to California.

Section 9 - Landscape Design Guidelines

TABLE 9-4
MASTER PLANT PALETTE

BOTANICAL NAME	COMMON NAME	ACCENT	VERTICAL SCREEN/ BACKGROUND	STREET TREE	UNDERSTORY TREE	PARKS & TRAILS	RIPARIAN ZONE	CONIFEROUS FOREST	CALIFORNIA/HILLSIDE FRIENDLY ZONE	FUEL MOD SLOPES
----------------	-------------	--------	--------------------------------	-------------	-----------------	----------------	---------------	-------------------	--------------------------------------	-----------------

SHRUBS										
Aeonium arboreum	Tree Aeonium	•				•				
Agave attenuata	N.C.N	•								•
Agave desmettiana ‘Variegata’	Variegated Dwarf Century Plant	•				•				
Agave vilmoriniana	Octopus Agave	•				•				
Aloe arborescens	Tree Aloe	•				•				
Aloe striata	Coral Aloe	•				•				
Alogyne huegeii	Blue Hibiscus									•
Anigozanthos manglesii	Kangaroo Paw					•			•	
Artemisia caucasica	Caucasian Artemisia							•		•
Baccharis ‘Centennial’	Coyote Brush								•	•
Baccharis salicifolia	Mulefat									•
Bougainvillea ‘Hawaii’	Variegated Bougainvillea	•				•				
Buxus m. japonica	Japanese Boxwood	•				•				
Carissa grandiflora ‘Boxwood Beauty’	Natal Plum					•		•	•	
Ceanothus ‘Concha’	Ceanothus						•		•	•
Ceanothus g. horizontalis	Carmel Creeper						•		•	•
Chondropetalum tectorum	Cape Rush	•					•			
Cistus hybridus	White Rockrose								•	•
Coprosma repens ‘Marble Queen’	Mirror Plant	•								
Cotoneaster lacteus	Parney Cotoneaster					•	•		•	
Elaeagnus pungens	Silverberry									•
Encelia californica	California Encelia								•	•
Eschscholzia californica	California Poppy	•								•
Feijoa sellowiana	Pineapple Guava	•				•				
Fremontodendron californicum	California Flannelbush								•	•
Hemerocallis ‘Dwarf Yellow’	Day Lily	•								
Hesperaloe parviflora	Red Yucca								•	•
Juncus patens	California Gray Rush						•			
Lantana sellowiana ‘Monma’	White Lightin’ Trail Lantana	•							•	
Leucophyllum laevigatum	Chihuahuan Sage (Texas Ranger)					•			•	
Lomandra longifolia ‘LM300’	Breeze Dwarf Mat Rush						•			
Lupinus bicolor	Sky Lupine	•								•
Mandevilla splendens “Red riding Hood”	Mandevilla	•						•		
Melaleuca nesophila	Pink Melaleuca					•				
Mimulus species	Monkeyflower								•	•
Moraea bicolor	Fortnight Lily	•				•				
Muhlenbergia rigens	Deer Grass							•	•	

TABLE 9-4
MASTER PLANT PALETTE

BOTANICAL NAME	COMMON NAME	ACCENT	VERTICAL SCREEN/ BACKGROUND	STREET TREE	UNDERSTORY TREE	PARKS & TRAILS	RIPARIAN ZONE	CONIFEROUS FOREST	CALIFORNIA/HILLSIDE FRIENDLY ZONE	FUEL MOD SLOPES
Myoporum parvifolium 'Putah Creek'	Prostratum Myoprum							•	•	
Myrtus communis	True Myrtle	•				•		•		
Nassella (stipa) pulchra	Purple Needlegrass									•
Nemophila menziesii	Baby Blue Eyes								•	•
Opuntia littoralis	Prickly Pear	•							•	•
Phormium cookianum	Green Flax	•				•		•	•	
Pittosporum species	Tobira	•				•		•	•	
Plumbago capensis	Cape Plumbago								•	•
Quercus dumosa	Coastal Scrub Oak					•				•
Rhamnus californica	Coffeeberry								•	•
Raphiolepis species	Indian Hawthorne	•						•	•	
Rhus ovata	Sugar Bush								•	•
Ribes speciosum	Flowering Gooseberry								•	•
Rosa F. 'Ice Berg'	White Shrub Rose	•						•		
Rosmarinus o. 'Prostratus'	Trailing Rosemary					•		•	•	
Rosmarinus o. 'Tuscan Blue'	Rosemary	•							•	
Salvia greggii	Autumns Sage					•			•	
Salvia greggii 'Sierra Linda'	Red Salvia	•							•	
Senecio mandraliscae	N.C.N.	•							•	
Strelizia reginae	Bird-of-Paradise	•							•	
Thevetia peruviana	Yellow Oleander	•						•		
Viburnum tinus 'Spring Bouquet'	Laurustinus					•			•	
Westringia fruticosa 'Wynabbie Gem'	Coast Rosemary					•			•	
Xylosma congestum	Xylosma					•		•		
Yucca whipplei	Our Lord's Candle								•	•

DEVELOPMENT REGULATIONS

Section 10.0

November 2016



INTRODUCTION

10.1

The provisions contained herein, along with those contained within the Development Agreement, regulate design and development within Serrano Summit.

DEFINITION OF TERMS

10.2

The meaning and construction of words, phrases, titles, and terms shall be the same as provided in Section 9.04.030, "Definitions," in the City of Lake Forest Municipal Code, unless otherwise specifically provided herein. The definitions of residential product types shall be those defined in Section 4, "Land Use," of the Serrano Summit Area Plan, within the discussion of each respective land use district.

ADMINISTRATION

10.3

The Serrano Summit Area Plan, upon adoption, in addition to the Development Agreement, will serve as an implementation tool for the General Plan, as amended, to guide the growth of the community. The Serrano Summit Area Plan Development Regulations address the general provisions and development standards for the community.

GENERAL PROVISIONS

10.4

The following provisions shall apply to all proposed land development within Serrano Summit.

1. Gross Acres - Except as otherwise indicated, gross acres for all development areas are measured to the centerline of streets.
2. Grading - Development within the Serrano Summit area shall utilize grading techniques as approved by the City of Lake Forest and shall be in accordance with the City's Grading Ordinance and Grading Manual. Grading concepts shall respond to the design guidelines included in the Serrano Summit Area Plan that promote a livable community with streets and public realm areas designed for walking and resident interaction.
3. Building Modification - Additions and alterations permitted by the Serrano Summit Area Plan shall match the architectural style of the primary unit and shall be constructed of the same materials, details, and colors as the primary unit.
4. Utilities - All new and existing public utility distribution lines of 35.5kV or less shall be subsurface within the Serrano Summit boundaries.
5. Technology - All homes and businesses shall accommodate modern telecommunications technology for computer internet access, phone, fax, and television. If available locally, broadband fiber optics cable will be installed to all the properties. See Section 5.9 for more information.
6. Transfer of Density - The Serrano Summit Area Plan allocates a gross density to each Planning Area as indicated in Table 4-1, "Development Summary by Planning Area" in Section 4, of the Serrano Summit Area Plan. Variations in the gross density within any Planning Area may occur at the time of final design of the Planning Area depending upon the residential product identified for development as part of the 'B' Map process. Changes in residential density for the Planning Area are permitted among and between all of the residential Planning Areas (i.e., Planning Areas 1, 2, 3, 4, 5, 6, 7, 8, 9, 10, 11 and 12) within Serrano Summit, provided that the density of each residential planning area does not exceed 25 dwelling units per acre and the total number of residential dwelling units permitted within Serrano Summit does not exceed 608 dwelling units, with an additional 225 dwelling units in Planning Area 13 if the Civic Center is not constructed.
7. Best Management Practices - Development of storm water runoff improvements within Serrano Summit shall adhere to currently adopted Best Management Practices (BMP's). The Site Design BMP's may include but not be limited to, Water Quality Management Plan basins. Common area landscaping and parks may be designed to function as a series of shallow storm water treatment basins and infiltration zones for storm water runoff from surrounding areas wherever moderately well draining soils exist.
8. Maximum Number of Dwelling Units - The maximum number of residential dwelling units permitted within Serrano Summit for Planning Areas 1 through 12 is 608 dwelling units, with an additional 225 dwelling units in Planning Area 13 if the Civic Center is not constructed.
9. Approval of this Area Plan - This Area Plan has been approved by Resolution No. ___ and adopted by the City Council. Approval of the Serrano Summit Area Plan includes the approval of a "Master Land Use Plan," contained within this Area Plan.
10. Solid Waste/Recycling - Development within Serrano Summit shall comply with City of Lake Forest requirements for the provision and placement of solid waste and recycling receptacles. All homes subject to individual trash pick-up (rather than those that utilize centralized trash enclosures) shall be provided with a minimum of three separate portable wheeled containers for waste, recycling and green waste. The containers may be provided by the waste hauler. These containers shall either be stored in an enclosed garage or in a side or rear yard so as not to be visible from any public street, except during days of trash pickup or on the evening before standard trash pickup takes place.

SUSTAINABILITY DEVELOPMENT REGULATIONS

10.5

The enforcement of the following regulations shall be the responsibility of the project master developer.

Structures & Site Development

1. All homes shall accommodate technology for computer internet access, phone, fax, and television.
2. All homes shall be equipped to accommodate recharging of “plug in hybrid” vehicles.
3. Construction activities within Serrano Summit shall implement a construction waste management plan outlining on-site measures for minimizing and recycling construction waste.
4. The use of exterior building materials that do not require painting or coating is encouraged.
5. The use of recycled materials is encouraged including the use of wood certified by the Forest Stewardship Council.
6. Visible roof materials shall have a 30-year minimum life expectancy.
7. Buildings shall utilize proper insulation in walls and ceilings as well as a radiant barrier at the roof.
8. Heating, air conditioning, and ventilation systems shall incorporate a programmed thermostat.
9. Low energy windows are required for all windows.
10. All bathrooms shall provide motion detectors on light switches as required by the Building Code and high efficiency plumbing fixtures shall be used.
11. The use of interior low energy lighting fixtures and bulbs throughout all public buildings is required, whenever feasible.
12. Exterior electrical outlets on the front and rear of all buildings to allow for electric landscape maintenance equipment should be provided.

Landscape Sustainability

1. The plant palette of California-friendly and water wise plants included in the Area Plan shall be utilized. Plants shall be grouped in combinations with similar water and sun exposure needs. Grouping plants with similar needs will reduce the chance of over watering or

under watering and will allow growth without risk of disease or failure due to improper irrigation.

2. A layer of 2-3 inches of bark mulch shall be installed in all planters. The mulch will retard weed growth and thus reduce the labor required for weed abatement and the need for chemical applications to control weed growth. In addition, the bark mulch will reduce the loss of moisture from the soil by evaporation and keep the root zone of the plants cooler.
3. Irrigation shall utilize low flow bubblers and spray heads, where applicable, to reduce the probability of water run off and overspray.
4. The use of an irrigation controller equipped with soil moisture sensor, rain shut off, and wind shut off capabilities is encouraged. It is recommended that the controller be able to adjust station run times to daily evapotranspiration updates. Utilizing these tools, management of the irrigation system will be automated and will reduce the labor required to provide system adjustments based on seasonal change. These mechanisms will also reduce the volume of water applied to planting areas otherwise wasted using typical time clock controllers.

RESIDENTIAL DISTRICT STANDARDS

10.6

Adoption of the development regulations described in Section 10, "Development Regulations," in this Area Plan shall be through a "master" Use Permit for all Serrano Summit planning areas.

Single Family Detached Residential (SFD)

General

This category includes the development of single-family detached dwelling units. The purpose of the residential standards for single-family detached housing is to establish the minimum criteria for the development of these product types on individual lots or as condominium style single family detached developments within the Planning Areas specified within Serrano Summit.

Permitted Uses and Facilities

1. Single family detached dwellings and garages.
2. Public or private parks, non-lighted athletic fields, community centers, senior centers, recreational buildings, greenbelts, and open space.
3. Accessory uses to include the following:
 - a. *Second Dwelling Units, in accordance the City of Lake Forest Municipal Code.*
 - b. *Home occupations per Section 9.146.060 of the Lake Forest Municipal Code.*
 - c. *Guest houses.*
 - d. *Storage sheds.*
 - e. *Gazebos, cabanas and other similar structures.*
 - f. *Home schools.*
 - g. *Swimming pools, spas, and other similar outdoor recreational amenities.*
 - h. *Patios and patio covers.*
 - i. *Storage, garden structures, cabanas, and greenhouses.*
 - j. *Monument signage.*
 - k. *Model home and subdivision sales trailers; temporary construction parking, offices, and facilities; real estate signs, signage indicating future development and directional signage in accordance with the City of Lake Forest Code.*
 - l. *Second and third story additions to existing single story dwelling units.*

- m. *Small family child care/day care facilities (up to 6 children), in accordance with the City of Lake Forest Municipal Code.*
- n. *Drop boxes for overnight delivery service providers.*
- o. *Domestic household pets in accordance with the City of Lake Forest Municipal Code.*
- p. *Parking lots associated with permitted uses.*
- q. *Signs associated with permitted uses and as approved per the City of Lake Forest sign permit procedures.*

Conditionally Permitted Uses and Facilities

1. Places of worship including, but not limited to, churches and synagogues.
2. Congregate care facilities.
3. Minor communications facilities.
4. Parking lots associated with conditionally permitted uses.

Temporary Uses

1. Temporary uses shall be permitted pursuant to Section 9.144.070, "Temporary Uses and Structures," of the City of Lake Forest Municipal Code.

Recreational Vehicle Storage & Parking

1. Recreational Vehicle (RV) storage is prohibited on public and private streets, private lanes, and in sideyards. RV parking is restricted to public and private streets and is limited to 24 hours.

Single Family Detached Residential Development Standards

The regulations governing development of single family detached residential dwelling units within Serrano Summit are provided in Table 10-1, "Single Family Detached Residential Development Standards."

TABLE 10-1 SINGLE FAMILY DETACHED RESIDENTIAL DEVELOPMENT STANDARDS ⁹			
(TABLE APPLIES TO FEE SIMPLE HOUSING ONLY)			
	FRONT LOADED 50'+ WIDE	FRONT LOADED 40' WIDE	SFD REAR LOADED
LOT CRITERIA			
MIN. LOT WIDTH	50'	40'	30'
MIN. LOT WIDTH AT KNUCKLE OR CUL-DE-SAC	35'	35'	N/A
MIN. LOT WIDTH AT CORNER LOT	55'	45'	35'
MIN. LOT DEPTH	80'	70'	50'
MIN. LOT AREA	4,000 sf	2,800 sf	1,500 sf
FRONT SETBACKS (FROM PROPERTY LINE)¹			
LIVING AREA	10'	10'	10' ²
PORCH (SINGLE STORY PLATE LINE)	5'	5'	5' ²
STREET FACING GARAGE	18'	18'	N/A
TURN-IN GARAGE	10'	N/A	N/A
FRONT YARD SETBACK FROM 'B' STREET (APPLIES TO 'B' STREET ONLY)	15'	15'	15'
SIDE SETBACKS (FROM PROPERTY LINE)¹			
INTERIOR PROPERTY LINE	5'	5'	5'
REAR SETBACKS (FROM PROPERTY LINE)¹			
MAIN STRUCTURE	15'	15'	3'
GARAGE	5'	5'	3' from alley ROW
PATIO COVER OR SECOND STORY DECK	5'	5'	3'
PARK LANDSCAPE BUFFER⁸			
MEASURED FROM PROPERTY LINE	3'	3'	3'
LOT COVERAGE			
MAX. COVERAGE	60%	60%	60%
MAXIMUM BUILDING HEIGHT³			
MAIN STRUCTURE	35'	35'	35'
GARAGE (SINGLE STORY)	15'	15'	15'
GARAGE WITH SECOND UNIT ABOVE	35'	35'	35'
WALLS, FENCES, AND HEDGES			
MAX. HEIGHT IN FRONT SETBACK AREA ⁴	42"	42"	42"
MAX. HEIGHT AT INTERIOR OR REAR PL ⁵	6'	6'	6'
REQUIRED PARKING (PER LAKE FOREST MUNICIPAL CODE CHAPTER 9.168, SPECIFICALLY AS FOLLOWS:)			
TOTAL PARKING REQUIRED IN ENCLOSED GARAGE ^{6,10}	2 spaces/unit	2 spaces/unit	2 spaces/unit
GUEST PARKING REQUIRED ¹⁰	0.2 space/unit ⁷	0.2 space/unit ⁷	0.2 space/unit ⁷
OPEN SPACE			
PRIVATE OPEN SPACE	100 sf on the ground floor with a min. dimension of 6'	100 sf on the ground floor with a min. dimension of 6'	100 sf on the ground floor with a min. dimension of 6'

TABLE 10-1 FOOTNOTES

1. Architectural projections may project a maximum of 3 feet into required front, rear or side setback areas; however, in no case shall such projection be closer than 3 feet to any property line. An architectural projection is defined as an element that articulates the building elevation such as eaves, window and door pop-out surrounds, media niches, bay windows, pot shelves, chimneys, enhanced window sills, shutter details, window trim, balconies and entry gates, and other similar elements. Not applicable to paseo or court fronting units. Refer to minimum building separation requirements.
2. Not applicable to paseo or court fronting units. Refer to minimum building separation requirements.
3. Architectural projections such as chimneys, cupolas, and similar features may exceed the maximum height limit by 10 feet.
4. Solid masonry walls or fencing materials may be permitted 2' from the back of the sidewalk as long as they have a max height of 42". Combination retaining walls and wall/fence combinations can exceed 42" in height. Fences, walls, hedges or similar view obstructing structures or plants that reduce safe ingress or egress of vehicles or pedestrians shall not exceed 42" in height in any required front yard. Walls with plexiglass are restricted to areas with view opportunities.
5. Walls may exceed 6 feet in height for noise attenuation purposes subject to an approved Acoustical Study, and may have a max. height of 9 feet if a combination wall/fence/hedge, stepped wall or fence, and/or retaining wall is necessary.
6. All parking spaces to be enclosed with a minimum 20' x 20' clear inside dimension for two spaces and 10' x 20' for single spaces.
7. Required guest parking can be provided on-street or within designated open parking areas.
8. Where private property (excepting streets and alleyways) abuts a public neighborhood park in Planning Areas 15 and 16, a three foot wide landscape buffer shall be provided consisting of a low hedge, shrubs, or a low wall or fence, not to exceed three feet in height, unless a taller wall for privacy purposes is permitted by the City of Lake Forest Planning Department.
9. Development Standards approved through Use Permit 9-11-2132, in accordance with Lake Forest Municipal Code Section 9.124, Planned Development Combining District.
10. All parking spaces shall comply with the applicable sections of Lake Forest Municipal Chapter 9.168, and specifically 9.168.020, which states that if the decision-maker determines minimum parking standards are inadequate for a specific project, he may require the developer, owner or operator of any specific use to provide the adequate parking even though such addition may be in excess of the minimum requirements set forth in this section.

See Table 10-1 Development Standards: Front Loaded Small Lot
 - Single-Family Detached (2,800 SF Min. Lot)

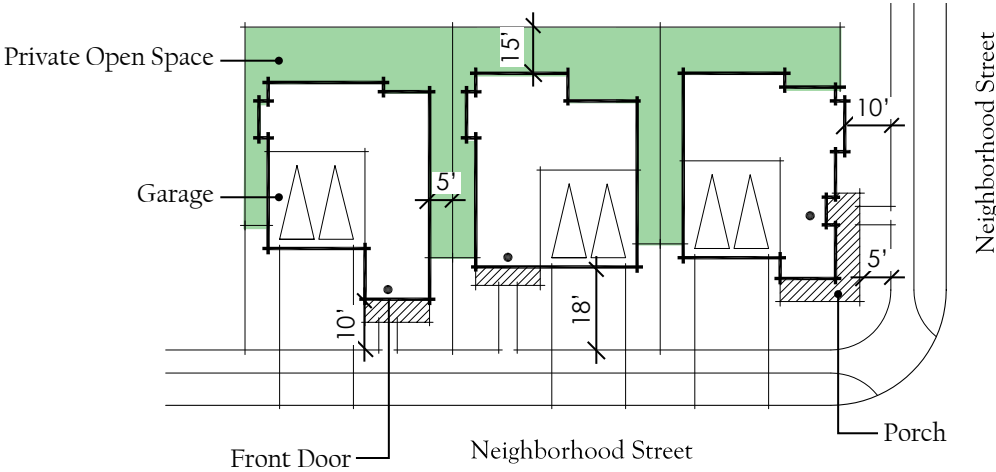

Drawing Not to Scale



Product Type Examples
 (For illustrative purposes only; actual floor plans and lotting may vary)

DESIGN INTENT

Provide corner lot elevation enhancement through side-entry or wrap porch on corner lot.	Promote neighbor interaction with front porches forward of the garage.
Provide eyes-on-the-street through living-forward floor plan design.	Create articulation in streetscene through front elevation offsets.

See Table 10-1 Development Standards: SFD Rear Loaded

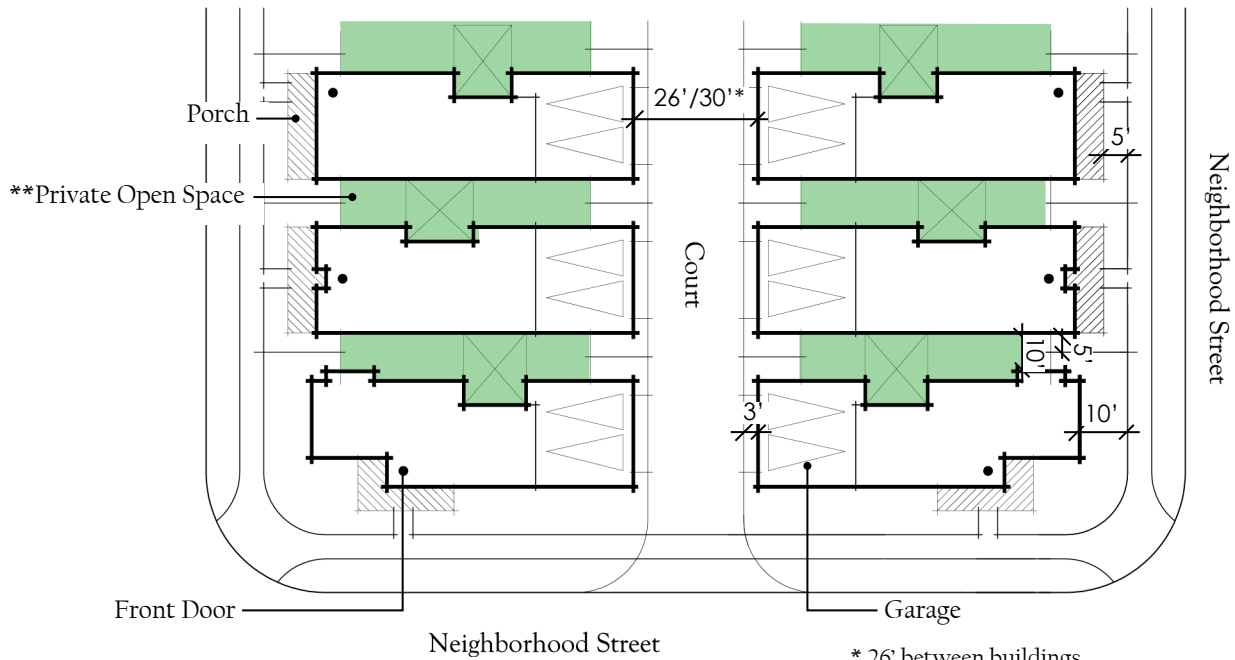

Drawing Not to Scale

* 26' between buildings
30' between garage doors

** Private Open Space is created through easment.



Product Type Examples

(For illustrative purposes only; actual floor plans and lotting may vary)

DESIGN INTENT

Limit garage door dominance on streetscene by utilizing rear-loaded garages.

Reduce driveway cuts along neighborhood streets to create a safer pedestrian environment.

Provide eyes-on-the-street through living-forward floor plan design.

Use architectural elements to articulate front elevation.

Provide corner lot elevation enhancement through side-entry on corner lot or wrap porch.

Create articulation in street scene through front elevation offsets.

Ease side yards to maximize yard useability.

Single Family Detached Enclave Residential (SFD-E)

General

This category includes the development of single-family detached enclave and motor court/green court dwelling units. The purpose of the residential standards for detached enclave housing is to establish the minimum criteria for the development of these product types as condominium style detached enclave and motor court/green court developments within the Planning Areas specified within Serrano Summit.

Permitted Uses and Facilities

1. Single family detached enclave dwellings and garages.
2. Public or private parks, non-lighted athletic fields, community centers, senior centers, recreational buildings, greenbelts, and open space.
3. Accessory uses to include the following:
 - a. *Second Dwelling Units, in accordance the City of Lake Forest Municipal Code.*
 - b. *Home occupations per Section 9.146.060 of the Lake Forest Municipal Code.*
 - c. *Storage sheds.*
 - d. *Gazebos, cabanas and other similar structures.*
 - e. *Home schools.*
 - f. *Swimming pools, spas, and other similar outdoor recreational amenities.*
 - g. *Patios and patio covers.*
 - h. *Storage, garden structures, cabanas, and greenhouses.*
 - i. *Monument signage.*
 - j. *Model home and subdivision sales trailers; temporary construction parking, offices, and facilities; real estate signs, signage indicating future development and directional signage in accordance with the City of Lake Forest Municipal Code.*
 - k. *Second story additions to existing single story dwelling units.*
 - l. *Small family child care/day care facilities (up to 6 children), in accordance with the City of Lake Forest Municipal Code.*
 - m. *Drop boxes for overnight delivery service providers.*
 - n. *Domestic household pets in accordance with the City of Lake Forest Municipal Code.*
 - o. *Parking lots associated with permitted uses.*
 - p. *Signs associated with permitted uses and as approved per the City of Lake Forest sign permit procedures.*

Conditionally Permitted Uses and Facilities

1. Places of worship including, but not limited to, churches and synagogues.
2. Congregate care facilities.
3. Minor communications facilities.
4. Parking lots associated with conditionally permitted uses.

Temporary Uses

1. Temporary uses shall be permitted pursuant to Section 9.144.070, "Temporary Uses and Structures," of the City of Lake Forest Municipal Code.

Recreational Vehicle Storage & Parking

1. Recreational Vehicle (RV) storage is prohibited on public and private streets, private lanes, and in sideyards. RV parking is restricted to public and private streets and is limited to 24 hours.

Single Family Detached Enclave Residential Development Standards

The regulations governing development of single family detached enclave residential dwelling units within the Serrano Summit project boundaries are provided in Table 10-2, "Single Family Detached Enclave Residential Development Standards."

Section 10 - Development Regulations

TABLE 10-2
SINGLE FAMILY DETACHED ENCLAVE RESIDENTIAL DEVELOPMENT STANDARDS^{1,4}

	URBAN COURT	REAR LOADED DUPLEX	MOTOR COURT/ GREEN COURT
LOT CRITERIA			
MINIMUM LOT WIDTH	NO REQUIREMENT	NO REQUIREMENT	NO REQUIREMENT
MINIMUM LOT DEPTH	NO REQUIREMENT	NO REQUIREMENT	NO REQUIREMENT
MINIMUM LOT AREA	NO REQUIREMENT	NO REQUIREMENT	NO REQUIREMENT
PROPERTY LINE SETBACKS^{1,2,3}			
FRONT TO EXTERIOR PROPERTY LINE ¹¹	10'	10'	10'
SIDES & REAR TO EXTERIOR PROPERTY LINE ¹¹	5'	5'	5'
FRONT, SIDES & REAR TO INTERIOR PROPERTY LINE ¹²	per CA Building Code	5'	5'
SETBACKS (FROM THE PROPERTY LINE OF LOCAL STREETS)^{2,3}			
LIVING AREA	5'	10'	10'
PORCH (SINGLE STORY PLATE LINE)	3'	5'	5'
STREET FACING GARAGE	18'	18'	18'
ALLEY FACING GARAGE	3'	3'	3'
FRONT YARD SETBACK FROM 'B' STREET (APPLIES TO 'B' STREET ONLY)	15'	15'	15'
PARK LANDSCAPE BUFFER¹³			
MEASURED FROM PROPERTY LINE	3'	3'	3'
MINIMUM BUILDING SEPARATION¹⁶			
MINIMUM DISTANCE BETWEEN STRUCTURES W/O PASEO OR GREENWAY (WITH ZERO OPENINGS)	6'	6'	6'
MINIMUM DISTANCE BETWEEN STRUCTURES W/O PASEO OR GREENWAY (WITH MAXIMUM 25% OPENINGS)	6'-6"	6'-6"	6'-6"
MINIMUM DISTANCE BETWEEN STRUCTURES SEPARATED BY PASEO OR GREENBELT ²	10'	10'	10'
FRONT DOOR TO ADJACENT STRUCTURES	12'	12'	12'
GARAGE DOOR TO GARAGE DOOR	30'	30'	30'
BETWEEN LIVABLE AREAS ACROSS AN ALLEY (AT 2ND AND 3RD LEVELS)	26'	26'	26'
MAXIMUM BUILDING HEIGHT			
MAIN STRUCTURES ⁵	36'-6"	35'	35'
WALLS, FENCES, AND HEDGES			
MAX. HEIGHT AT FRONT AND STREET SIDE PROPERTY LINE ⁶	42"	42"	42"
MAX. HEIGHT AT INTERIOR OR REAR PROPERTY LINE ^{7,12}	6'	6'	6'
OPEN SPACE			
PRIVATE OPEN SPACE	100 sf on the ground floor with a min. dimension of 6' OR 60 sf on upper floors with a min. dimension of 5'	100 sf on the ground floor with a min. dimension of 6' OR 60 sf on upper floors with a min. dimension of 5'	100 sf on the ground floor with a min. dimension of 6' OR 60 sf on upper floors with a min. dimension of 5'

TABLE 10-2 SINGLE FAMILY DETACHED ENCLAVE RESIDENTIAL DEVELOPMENT STANDARDS			
	URBAN COURT	REAR LOADED DUPLEX	MOTOR COURT/ GREEN COURT
PARKING			
REQUIRED OFF-STREET PARKING ^{8,9,10,15}	Per Lake Forest Municipal Code Chapter 9.168, specifically 2 spaces per unit + 0.2 guest parking		

TABLE 10-2 FOOTNOTES

1. Each building shall have only one front elevation and one rear elevation. All other elevations shall be deemed to be side elevations. The City shall determine which building elevation shall be designated as the “front” elevation for the purposes of this Section. In most cases, the “rear” elevation shall be deemed to be the opposite elevation from the front elevation.
2. Distance is measured from the property line. Not applicable to paseo or court fronting units. Refer to minimum building separation requirements.
3. Architectural projections may project a maximum of 3 feet into required setback areas; however, in no case shall such projection be closer than 3 feet to any property line. An architectural projection is defined as an element that articulates the building elevation such as eaves, window and door pop-out surrounds, media niches, bay windows, pot shelves, chimneys, enhanced window sills, shutter details, window trim, balconies and entry gates, and other similar elements. Not applicable to paseo or court fronting units. Refer to minimum building separation requirements.
4. Architectural projections such as chimneys, cupolas, and similar features may exceed the max. height limit by 10’.
5. Solid masonry walls or fencing materials may be permitted 2’ from the back of the sidewalk as long as they have a max height of 42”. Combination retaining walls and wall/fence combinations can exceed 42” in height. Fences, walls, hedges or similar view obstructing structures or plants that reduce safe ingress or egress of vehicles or pedestrians shall not exceed 42” in height in any required front yard. Walls with plexiglass are restricted to areas with view opportunities.
6. Walls may exceed 6 feet in height for noise attenuation purposes subject to an approved Acoustical Study, and may have a max. height of 9 feet if a combination wall/fence/hedge, stepped wall or fence, and/or retaining wall is necessary.
7. All parking spaces to be enclosed with a minimum 20’ x 20’ clear inside dimension for two spaces, 10’ x 20’ for single spaces and 10’ x 38’ for tandem spaces. Use of tandem parking shall be evaluated on a case-by-case basis during the B Map process and/or future site development permit or use permit process, whichever comes first.
8. Required guest parking can be provided on-street or within designated open parking areas.
9. Unless identified as a covered space, parking spaces may be either covered or uncovered as determined by the builder. Covered spaces shall be either covered in a carport or an enclosed garage. Open spaces are parking spaces that are intended for use by project residents or their guests.
10. “Exterior property line” shall be defined as the planning area boundary for each product type.
11. “Interior property line” shall be defined as any subarea boundary line within an overall condo map used for phasing purposes.
12. Where private property (excepting streets and alleyways) abuts a public neighborhood park in Planning Areas 15 and 16, a three foot wide landscape buffer shall be provided consisting of a low hedge, shrubs, or a low wall or fence, not to exceed three feet in height, unless a taller wall for privacy purposes is permitted by the City of Lake Forest Planning Department.
13. Development Standards approved through Use Permit 9-11-2132, in accordance with Lake Forest Municipal Code Section 9.124, Planned Development Combining District.
14. All parking spaces shall comply with the applicable sections of Lake Forest Municipal Chapter 9.168, and specifically 9.168.020, which states that if the decision-maker determines minimum parking standards are inadequate for a specific project, he may require the developer, owner or operator of any specific use to provide the adequate parking even though such addition may be in excess of the minimum requirements set forth in this section.
15. All Rear Loaded Duplex homes are permitted to have a zero foot setback between units at the party wall.

See Table 10-2 Development Standards: Urban Court

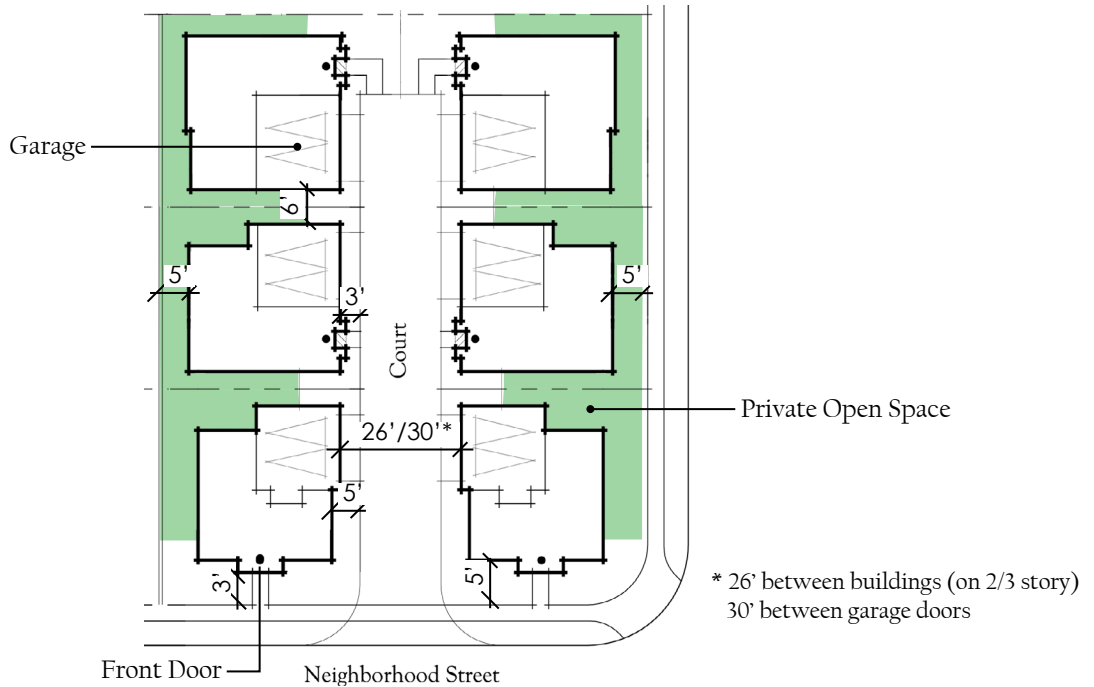

Drawing Not to Scale



Product Type Examples
(For illustrative purposes only; actual floor plans and lotting may vary)

DESIGN INTENT

Provide variety through floor plan design and orientation.	Reduce driveway cuts along neighborhood streets to create a safer pedestrian environment.
Limit garage door dominance on streetscene by loading garages off shared court.	Provide eyes-on-the-street for homes fronting neighborhood street through living-forward floor plan design.
Use architectural elements to articulate front elevation.	

See Table 10-2 Development Standards: Green Court

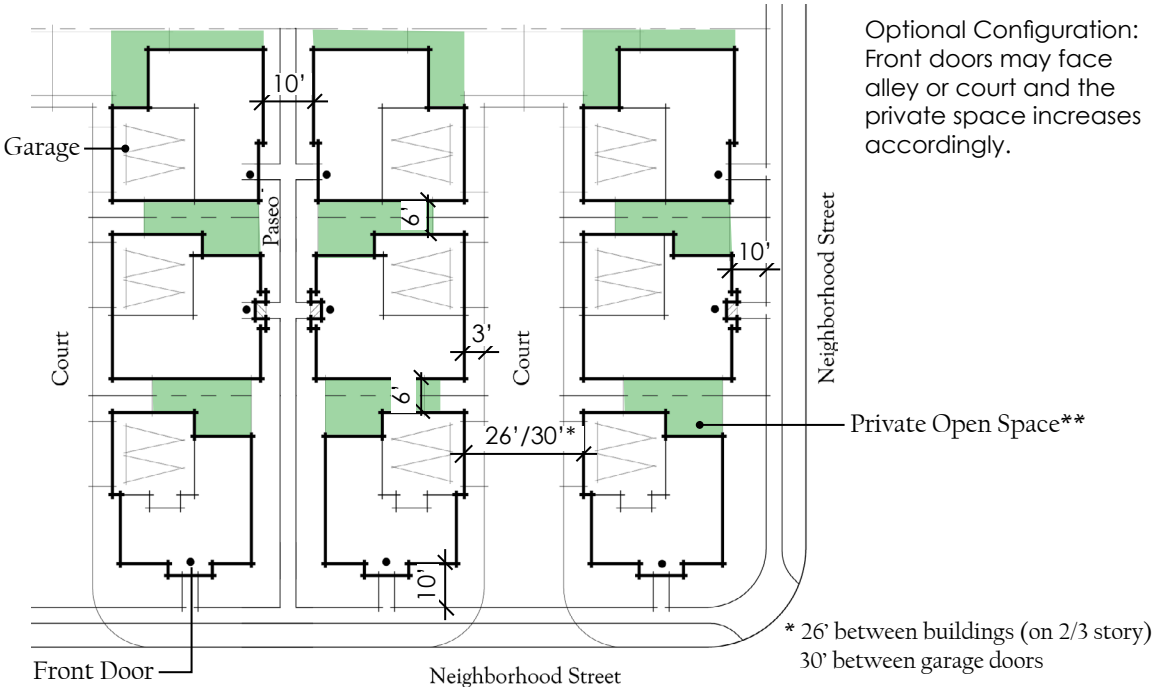

Drawing Not to Scale

** Private Open Space is created through easment.



Product Type Examples

(For illustrative purposes only; actual floor plans and lotting may vary)

DESIGN INTENT	
Provide variety through floor plan design and orientation.	Reduce driveway cuts along neighborhood streets to create a safer pedestrian environment.
Limit garage door dominance on streetscene by loading garages off shared court.	Provide eyes-on-the-street for homes fronting neighborhood street through living-forward floor plan design.
Promote neighbor interaction by orienting front entries around shared paseo.	Use architectural elements such as wide front elevations to articulate front elevation.

See Table 10-2 Development Standards: Motor Court

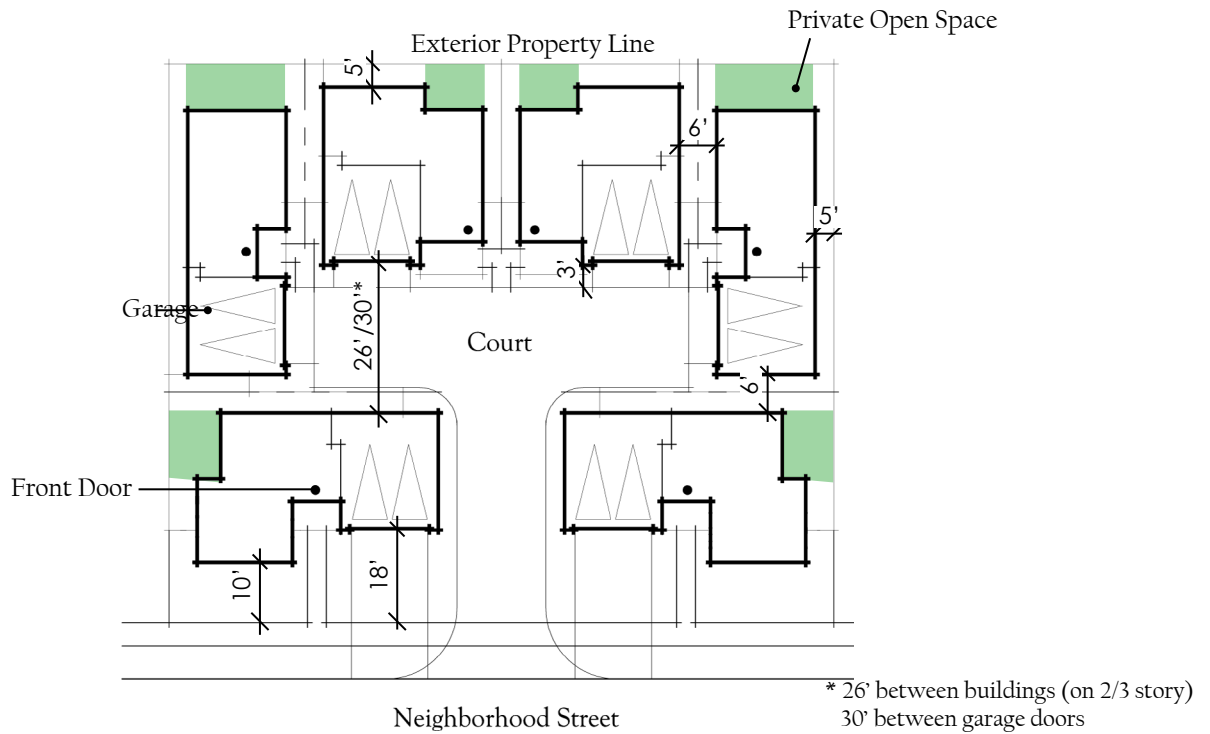

Drawing Not to Scale



Product Type Examples

(For illustrative purposes only; actual floor plans and lotting may vary)

DESIGN INTENT

Provide variety through floor plan design and orientation.	Reduce driveway cuts along neighborhood streets to create a safer pedestrian environment.
Limit garage door dominance on streetscene by loading garages off shared court.	Provide eyes-on-the-street for homes fronting neighborhood street through living-forward floor plan design.
Use architectural elements such as wide front elevations to articulate front elevation.	

See Table 10-2 Development Standards: Rear Loaded Duplex

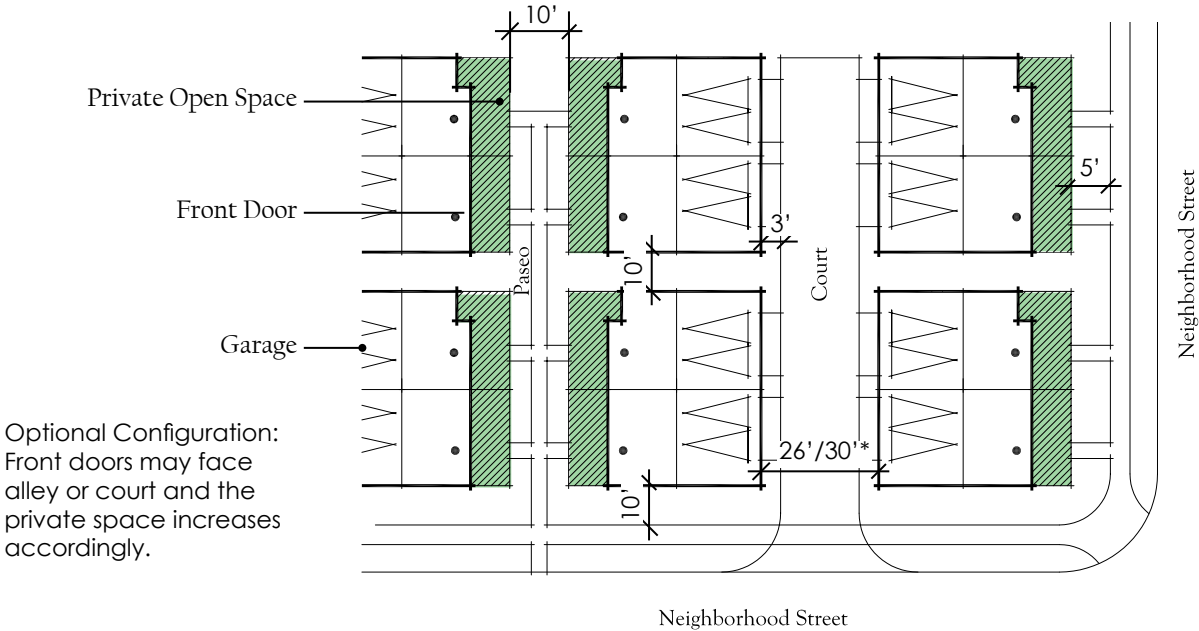

Drawing Not to Scale

* 26' between buildings (on 2/3 story)
30' between garage doors



Product Type Examples

(For illustrative purposes only; actual floor plans and lotting may vary)

DESIGN INTENT

Promote neighbor interaction by orienting front entries around shared passeo.	Reduce driveway cuts along neighborhood streets to create a safer pedestrian environment.
Provide variety through floor plan design and orientation.	Provide eyes-on-the-street for homes fronting neighborhood street through living-forward floor plan design.
Limit garage door dominance on streetscene by loading garages off shared court.	

Single Family Attached (SFA) and Multi-Family Attached (MFA) Residential Development Standards

General

This category includes the development of a variety of attached type residential and multi-family attached dwelling units including but not limited to rear loaded duplexes, townhomes, stacked flats, and apartments. Refer to Table 10-3 for more information.

Permitted Uses

1. Single family attached row townhomes, duplexes, townhomes, stacked flats, residential apartments, and associated parking facilities.
2. Public or private parks, non-lighted athletic fields, community centers, recreational buildings, greenbelts, and open space, associated parking facilities and ancillary buildings.
3. Accessory uses to include the following:
 - a. Home occupations per Section 9.146.060 of the Lake Forest Municipal Code.
 - b. Swimming pools, spas, tennis courts, sports courts, and other similar outdoor recreational amenities.
 - c. Patios, patio covers, gazebos, barbecues, and other similar structures.
 - d. Home schools.
 - e. Monument signage
 - f. Mailboxes.
 - g. Recreation center buildings.
 - h. Maintenance storage buildings.
 - i. Signage as permitted pursuant to any approved sign program and pursuant to the City of Lake Forest sign permit processes.
 - j. Model units, sales offices, and subdivision sales trailers, temporary construction offices and facilities, real estate signs, signage indicating future development and directional signage in accordance with the City of Lake Forest Municipal Code.
 - k. Small family child care/day care, up to 6 children in accordance with the City of Lake Forest Municipal Code.
 - l. Sales Offices and Permanent Leasing Offices.
 - m. Drop boxes for overnight delivery service providers.

Conditionally Permitted Uses

1. Places of worship including but not limited to churches and synagogues.
2. Congregate care facilities.
3. Minor communications facilities.
4. Parking lots and facilities associated with conditionally permitted uses.

Temporary Uses

1. Temporary uses shall be permitted pursuant to Section 9.144.070, "Temporary Uses and Structures," of the City of Lake Forest Zoning Ordinance.

Recreational Vehicle Storage and Parking

1. Recreational Vehicle (RV) storage is prohibited on public streets, private streets, in private lanes, and in sideyards. RV parking is restricted to public and private streets and is limited to 24 hours.

Tandem Parking

1. Use of tandem parking shall be evaluated on a case-by-case basis during the B Map process.

Single Family Attached Residential Development Standards

The regulations governing development of single family attached residential dwelling units within the Serrano Summit project area are provided in Table 10-3, "Single Family Attached and Multi-Family Attached Residential Development Standards."

**TABLE 10-3
SINGLE FAMILY ATTACHED AND MULTI-FAMILY ATTACHED RESIDENTIAL
DEVELOPMENT STANDARDS^{1,4}**

	TOWNHOMES, TRIPLEXES	REAR-LOADED STACKED FLATS	FRONT-LOADED STACKED FLATS
LOT CRITERIA			
MINIMUM LOT WIDTH	NO REQUIREMENT	NO REQUIREMENT	NO REQUIREMENT
MINIMUM LOT DEPTH	NO REQUIREMENT	NO REQUIREMENT	NO REQUIREMENT
MINIMUM LOT AREA	NO REQUIREMENT	NO REQUIREMENT	NO REQUIREMENT
MINIMUM SETBACKS (FROM THE PROPERTY LINE)^{1,2,3}			
FRONT TO EXTERIOR PROPERTY LINE ¹¹	10'	10'	10'
SIDES & REAR TO EXTERIOR PROPERTY LINE ¹¹	5'	5'	5'
FRONT, SIDES & REAR TO INTERIOR PROPERTY LINE ¹²	5'	5'	5'
SETBACKS (FROM BACK OF SIDEWALK OF LOCAL STREET)^{2,3}			
LIVING AREA	10'	10'	10'
PORCH/BALCONY	5'	5'	5'
STREET-FACING GARAGE	N/A	N/A	18'
ALLEY FACING GARAGE	3'	3'	3'
FRONT YARD SETBACK FROM 'B' STREET (APPLIES TO 'B' STREET ONLY)	15'	15'	15'
PARK LANDSCAPE BUFFER¹³			
MEASURED FROM PROPERTY LINE	3'	3'	3'
MINIMUM BUILDING SEPARATION¹			
BUILDING FRONT TO BUILDING FRONT	22' ¹²	22' ¹²	22' ¹²
BUILDING SIDE TO BUILDING SIDE	10' ¹³	10' ¹³	10' ¹³
BUILDING FRONT TO BUILDING SIDE	12'	12'	N/A
GARAGE DOOR TO GARAGE DOOR	30'	30'	N/A
BETWEEN LIVABLE AREAS ACROSS AN ALLEY (AT 2ND AND 3RD LEVELS)	26'	26'	N/A
LOT COVERAGE			
MAX. COVERAGE FOR A PLANNING AREA	40% per Lake Forest Municipal Code Sec. 9.124.060(B)(1)	40% per Lake Forest Municipal Code Sec. 9.124.060(B)(1)	40% per Lake Forest Municipal Code Sec. 9.124.060(B)(1)
AREA PER UNIT			
AREA PER UNIT	No Requirement	No Requirement	No Requirement
MAXIMUM BUILDING HEIGHT⁴			
MAIN STRUCTURE	40'	40'	40'
CARPORTS/DETACHED GARAGES	15'	15'	15'
WALLS AND FENCES			
MAXIMUM HEIGHT AT FRONT AND STREET SIDE OF PROPERTY LINE ⁵	42"	42"	42"
MAXIMUM HEIGHT AT INTERIOR OR REAR PROPERTY LINE ^{6,12}	6'	6'	6'
OPEN SPACE			
PRIVATE OPEN SPACE	100 sf on the ground floor w/ a min. dimension of 6' OR 60 sf on upper floors w/ a min. dimension of 5'	100 sf on the ground floor w/ a min. dimension of 6' OR 60 sf on upper floors w/ a min. dimension of 5'	100 sf on the ground floor w/ a min. dimension of 6' OR 60 sf on upper floors w/ a min. dimension of 5'

TABLE 10-3 SINGLE FAMILY ATTACHED AND MULTI-FAMILY ATTACHED RESIDENTIAL DEVELOPMENT STANDARDS			
	TOWNHOMES, TRIPLEXES	REAR-LOADED STACKED FLATS	FRONT-LOADED STACKED FLATS
REQUIRED OFF-STREET PARKING			
REQUIRED OFF-STREET PARKING - SINGLE-FAMILY AND MULTI-FAMILY ATTACHED ^{7,8, 9,15,16}	Per Lake Forest Municipal Code Chapter 9.168, specifically studio/1 bedroom unit requires 1 covered + 0.5 uncovered = 1.5 spaces total + 0.2 guest parking; 2 bedroom unit requires 2 covered + 0.5 uncovered = 2.5 spaces total + 0.2 guest parking; and 3 bedroom unit requires 3 covered + 0.5 uncovered = 3.5 total + 0.5 for additional bedrooms + 0.2 guest parking		

TABLE 10-3 FOOTNOTES

- Each building shall have only one front elevation and one rear elevation. All other elevations shall be deemed to be side elevations. The City shall determine which building elevation shall be designated as the “front” elevation for the purposes of this Section. In most cases, the “rear” elevation shall be deemed to be the opposite elevation from the front elevation.
- Architectural projections may project a maximum of 3 feet into required setback areas; however, in no case shall such projection be closer than 3 feet to any property line. An architectural projection is defined as an element that articulates the building elevation such as eaves, window and door pop-out surrounds, media niches, bay windows, pot shelves, chimneys, enhanced window sills, shutter details, window trim, entry gates, and other similar elements. Not applicable to paseo or court fronting units. Refer to minimum building separation requirements.
- Balconies may project 4 feet out into courtyards and patios may project up to 8 feet into courtyards.
- Architectural projections such as chimneys, cupolas, and other similar features may exceed the maximum permitted height by 10 feet.
- Solid masonry walls or fencing materials may be permitted on the front property line. Fences, walls, hedges or similar view obstructing structures or plants that reduce safe ingress or egress of vehicles or pedestrians shall not exceed 42” in height in any front yard. Combination retaining walls and wall/fence combinations can exceed 42” in height. Walls with plexiglass are restricted to areas with view opportunities.
- Walls may exceed six feet in height for noise attenuation purposes subject to an Acoustical Study and Planning Department approval.
- All parking spaces within an enclosed garage shall have a minimum 20’ x 20’ clear inside dimension for double spaces, 10’ x 20’ for single spaces, and 10’ x 38’ for tandem spaces.
- Use of tandem parking shall be evaluated on a case-by-case basis during the B Map process and/or future site development permit or use permit process, whichever comes first.
- Covered spaces shall be either covered in a carport or an enclosed garage. Open spaces are parking spaces that are intended for use by project residents or their guests.
- Lot area for SFA building types is defined as the development area for each building module.
- “Exterior property line” shall be defined as the planning area boundary for each product type.
- “Interior property line” shall be defined as any subarea boundary line within an overall condo map used for phasing purposes.
- Where private property (excepting streets and alleyways) abuts a public neighborhood park in Planning Areas 15 and 16, a three foot wide landscape buffer shall be provided consisting of a low hedge, shrubs, or a low wall or fence, not to exceed three feet in height, unless a taller wall for privacy purposes is permitted by the City of Lake Forest Planning Department.
- Development Standards approved through Use Permit 9-11-2132, in accordance with Lake Forest Municipal Code Section 9.124, Planned Development Combining District.
- All parking spaces shall comply with the applicable sections of Lake Forest Municipal Chapter 9.168, and specifically 9.168.020, which states that if the decision-maker determines minimum parking standards are inadequate for a specific project, he may require the developer, owner or operator of any specific use to provide the adequate parking even though such addition may be in excess of the minimum requirements set forth in this section.
- Required guest parking may be provided on local streets or within designated open parking areas.

See Table 10-3 Development Standards: Rear Loaded Townhomes

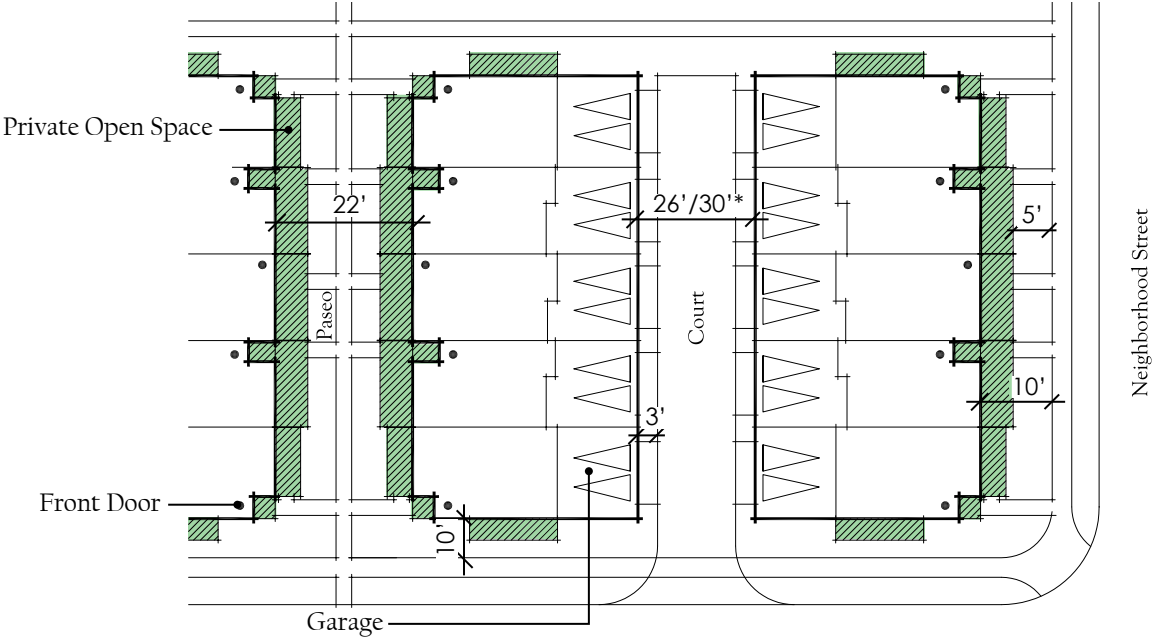

Drawing Not to Scale

Neighborhood Street

* 26' between buildings (on 2/3 story)
30' between garage doors



Product Type Examples

(For illustrative purposes only; actual floor plans and lotting may vary)

DESIGN INTENT

Promote neighbor interaction by orienting front entries around shared pasco.	Provide eyes-on-the-street for homes fronting neighborhood street through living-forward floor plan design.
Limit garage door dominance on streetscene by loading garages off shared court.	Use architectural elements such as wide front elevations to articulate front elevation.
Reduce driveway cuts along neighborhood streets to create a safer pedestrian environment.	

See Table 10-3 Development Standards: Rear Loaded Stacked Flats (with Carriage Units)

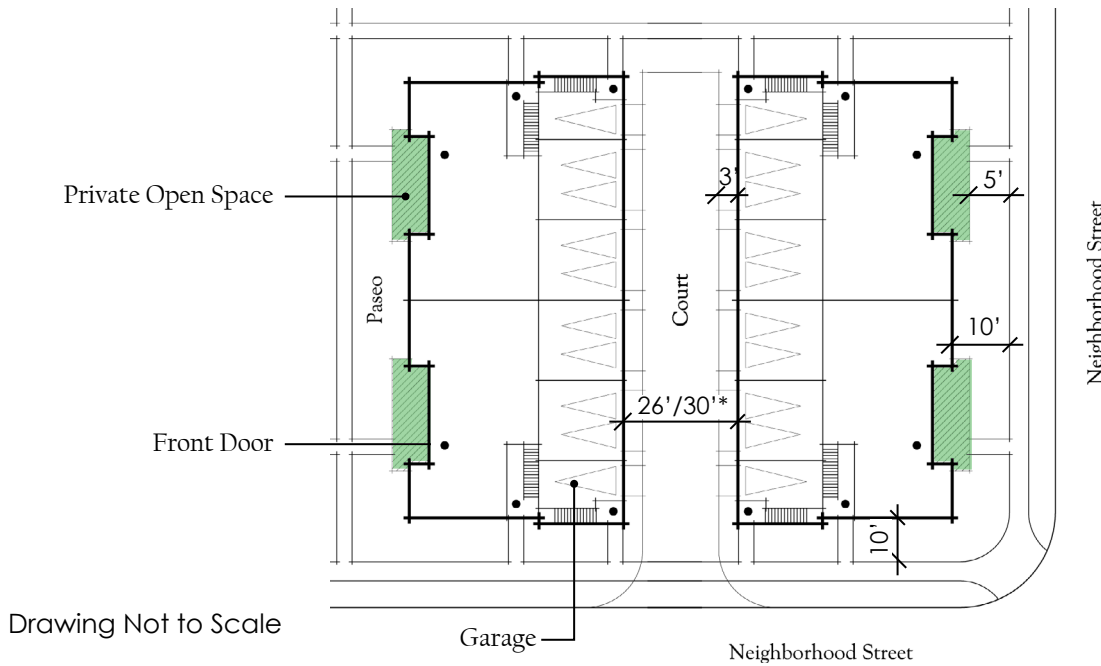

* 26' between buildings (on 2/3 story)
30' between garage doors



Product Type Examples

(For illustrative purposes only; actual floor plans and lotting may vary)

DESIGN INTENT

Provide variety through floor plan design and orientation.	Reduce driveway cuts along neighborhood streets to create a safer pedestrian environment.
Create opportunities for smaller units through carriage unit and stacked flat design.	Provide eyes-on-the-street for homes fronting neighborhood street through living-forward floor plan design.
Limit garage door dominance on streetscene by loading garages off shared court.	Use architectural elements such as wide front elevations to articulate front elevation.

AGRICULTURE (P. A. 18 & P. A. 19) AND P. A. 13 (PUBLIC FACILITIES OVERLAY)

10.7

General Provisions

This section sets forth the regulations for development of land uses within Serrano Summit.

The General Plan Designation for Planning Area 13 is Medium-Density Residential with a Public Facilities Overlay (PFO), which allows the site to be used for Civic Center purposes, including those municipal services commonly provided by general law cities at a city hall and civic center complex. Civic Center Design Guidelines are located within Section 8 of this Area Plan.

Permitted & Conditionally Permitted Uses

Permitted and Conditionally Permitted uses within the Agriculture (P.A. 18 and P.A. 19) district shall be as permitted and conditionally permitted in the City of Lake Forest's A1 Zone.

Permitted and Conditionally Permitted uses within Planning Area 13 (Public Facilities Overlay) shall be reflected to include the Residential District Standards (SFD, SFD-E, SFA, and MFA) in this Area Plan or a proposed Lake Forest Civic Center. The Lake Forest Civic Center shall be approved by the City Council through the design approval process.

Temporary Uses

Temporary uses are permitted in the Agriculture (P.A. 18 & P.A. 19) district and in Planning Area 13 (Public Facilities Overlay) subject to approval of a temporary use permit in accordance with the City of Lake Forest Municipal Code provisions for temporary uses. Temporary uses include, but are not limited to the following:

- Carnivals
- Circuses
- Holiday festivals/booths
- Seasonal Christmas tree/pumpkin lots
- Parking lot sales
- Sidewalk sales
- Street fairs and crafts shows
- Temporary structures and tents

TABLE 10-4 AGRICULTURE (P.A. 18 & P.A. 19) DEVELOPMENT STANDARDS	
MINIMUM DEVELOPMENT PARCEL AREA	N/A
MAXIMUM DEVELOPMENT FLOOR AREA RATIO	1.0
MINIMUM BUILDING SETBACKS ¹	
FROM PUBLIC STREET RIGHT-OF-WAY	15'
FROM PRIVATE STREET RIGHT-OF-WAY	15'
FROM INTERIOR PROPERTY LINES	0' if adjacent to parking or industrial or commercial use; , 20' if adjacent to open space uses, 50' if adjacent to residential or institutional uses
SURFACE PARKING AREAS & DRIVE AISLE SETBACKS	
FROM PUBLIC STREET RIGHT-OF-WAY	10'
FROM PRIVATE STREETS & DRIVE AISLES TO BUILDINGS	2'
MINIMUM LANDSCAPE COVERAGE	
MINIMUM LANDSCAPE COVERAGE	10%
MAXIMUM BUILDING HEIGHT	
MAIN STRUCTURE	45'
ARCHITECTURAL PROJECTIONS AND FOCAL ELEMENTS, SUCH AS TOWERS, CUPOLAS, AND OTHER APPURTENANCES	55'
PORTE-COCHERES ²	1 story
WATER RESERVOIRS AND TANKS	45'

FOOTNOTES

1. All setback areas shall be landscaped.
2. Porte-cocheres shall be open on three sides.

TABLE 10-5 PLANNING AREA 13 ONLY (PUBLIC FACILITIES OVERLAY) DEVELOPMENT STANDARDS*	
MINIMUM DEVELOPMENT PARCEL AREA	5 acres
MAXIMUM DEVELOPMENT FLOOR AREA RATIO	0.35
MINIMUM BUILDING SETBACKS ^{1,2}	
FROM PUBLIC STREET RIGHT-OF-WAY	20'
FROM INTERIOR PROPERTY LINES	0' if adjacent to parking, 20' if adjacent to a building, commercial, office, industrial or residential use
FROM ADJACENT OFF-SITE INDUSTRIAL USES	10'
FROM AREAS DESIGNATED AS OPEN SPACE	20'
SURFACE PARKING AREAS & DRIVE AISLE SETBACKS	
FROM PUBLIC STREET RIGHT-OF-WAY	10'
FROM PRIVATE STREETS & DRIVE AISLES TO BUILDINGS	3'
MINIMUM LANDSCAPE COVERAGE	
MINIMUM LANDSCAPE COVERAGE	15%
MAXIMUM BUILDING HEIGHT	
MAIN STRUCTURES	2 stories or 36', whichever is greater
ARCHITECTURAL PROJECTIONS AND FOCAL ELEMENTS, SUCH AS TOWERS, DOMES, CUPOLAS, AND OTHER APPURTENANCES	50'
PORTE-COCHERES ³	1 story
PARKING STRUCTURES	3 stories or 36', whichever is greater

FOOTNOTES

1. All setback areas shall be landscaped.
2. All setbacks are measured to habitable area not architectural appurtenance or projection. An architectural projection is defined as an element that articulates the building elevation such as eaves, window and door pop-out surrounds, bay windows, pot shelves, chimneys, enhanced window sills, shutter details, window trim, balconies, pedestrian colonnades and other similar elements. Such elements may project a maximum of 3 feet into setback areas.
3. Porte-cocheres shall be open on three sides.

* If the Civic Center is not constructed in Planning Area 13, then the development standards shall revert to the residential development standards contained in Tables 10-1, 10-2 and 10-3.

Transmission & Wireless Communication Towers

Transmission towers and wireless communication towers are prohibited in all planning areas within Serrano Summit, with the exception of Planning Area 19. Transmission and wireless communication towers are permitted in Planning Area 19 by right, up to a height of 50 feet (as measured from ground level), subject to review and approval by the Director of Development Services. Towers exceeding 50 feet in height (as measured from ground level) shall be submit to review and approval by the Planning Commission. All towers shall be subject to the requirements set forth in Chapter 9.162, "Wireless Communication Facilities," of the City of Lake Forest Municipal Code, except as amended herein.

SIGNAGE

10.9

A Master Sign Program shall be submitted by the developer of Serrano Summit and approved by the City of Lake Forest to address residential project entries, residential neighborhood identification signs, commercial signage, public facility identification signs, wayfinding signs, and any other signs identified as necessary by the developer for the successful signage of Serrano Summit. No project signs shall be permitted in the public right-of-way. All signs shall be subject to the approval of a sign permit pursuant to the provisions of Section 9.164, "Signs," of the City of Lake Forest Municipal Code.

Master Sign Program Contents

All sign programs shall address, at a minimum, the following:

- 1. Permitted signs.
- 2. Prohibited signs.

- 3. The hierarchy of signage.
- 4. Definition of types of signs.
- 5. Locations and dimensions for monument signs, neighborhood identification signs, and public facilities signs.
- 6. Locations and dimensions of directional signage.
- 7. Provisions for size, location, and duration of display of temporary signs.
- 8. Permitted sign types, styles, illumination, construction materials, colors, and lettering styles.
- 9. Requirements for a sign permit application.
 - a. Procedures for obtaining approval of a sign permit.
 - b. Procedures for amendments to the sign program.

LIGHTING

10.10

Street Lights Along Public Streets

Streetlights along public streets, within Serrano Summit shall be high-pressure sodium vapor. Design of fixtures shall be approved by the City of Lake Forest as part of the City's Design Review process.

Lane Lighting Fixtures

Lane lighting fixtures shall be on sensors for automatic nighttime lighting. Style and specifications for lane lights shall be approved by the City of Lake Forest.

Lighting within Parks, Paseos, Tot Lots and Other Areas

Lighting within parks, paseos, tot lots and other public areas shall be approved by the City of Lake Forest as part of the City's Design Review of these facilities.

Lighting Within Civic Center Complex

Lighting within the Civic Center complex shall be subject to review and approval by the City.

SITE FURNISHINGS

10.11

Site furnishings, including but not limited to, benches, barbecues, picnic tables, tables, gazebos, shade structures, pedestrian plaza furnishings, and refuse receptacles shall be approved as part of the City's required development review process.

BUS TURNOUTS & SHELTERS

10.12

Bus turnouts and shelters shall be installed as required by the City of Lake Forest and the Orange County Transportation Authority (OCTA). Bus shelters, if provided, shall be compatible with the architectural character of Serrano Summit. The design of the bus shelters shall be approved by the City and OCTA.

MAILBOXES

10.13

Mailboxes shall be clustered and installed in locations approved by the City of Lake Forest in accordance with the requirements of the United States Postal Service. The locations of delivery service drop boxes, such as Federal Express or UPS, shall be coordinated with the location of the clustered mailboxes.

MODEL HOME DEVELOPMENT STANDARDS

10.14

The purpose of this section is to provide standards for the development of model home complexes within Serrano Summit. Model home complexes containing temporary real estate offices used solely for the initial sale of homes within the boundaries of an approved tract are permitted within any and all Residential Planning Area(s). Model home complexes are permitted in accordance with these regulations and the permitting requirements contained in Section 11.8, "Development Review and Approval Process," of this Area Plan.

Permitted Structures and Uses

The following structures and uses may be constructed as a part of a temporary model home complex:

1. Model homes in compliance with the Area Plan development regulations applicable to the properties that are being sold.
2. Garages, attached and detached, in compliance with the Area Plan development regulations applicable to the properties that are being sold. Garages attached to units being used as model homes or attached and directly adjacent to model homes may be used as temporary sales offices.
3. Accessory buildings and structures in compliance with the Area Plan development regulations applicable to the properties being sold.
4. Recreational facilities that will be a permanent portion of the subdivision in compliance with the Area Plan development regulations applicable to the properties that are being sold.
5. Permanent streets and driveways that will be part of the subdivision after the abandonment of the real estate office use.
6. Temporary children's playgrounds.
7. Temporary and permanent fencing, walks, and structural amenities.
8. Temporary vehicle parking, driveway cuts, and maneuvering areas to provide off-street parking as necessary for employees and guests.

IMPLEMENTATION
Section 11.0

November 2016



OVERVIEW

11.1

The adoption of the Serrano Summit Area Plan by the City of Lake Forest follows the certification of the Serrano Summit EIR. Following the adoption of this Area Plan, the project area will be developed in several phases. The Area Plan serves as the implementation tool for the City of Lake Forest General Plan, as amended, to guide the development of the community. Following adoption of this Area Plan, development within the project area will proceed pursuant to approval by the City of Lake

Forest of applications for Site Development Permit, Use Permits and Subdivision Maps.

INTERPRETATION

11.2

Unless otherwise provided herein, any ambiguity concerning the content or application of the Serrano Summit Area Plan shall be resolved by the City's Planning Department in a manner consistent with the goals and objectives, purpose, and intent established in this Area Plan.

SEVERABILITY

11.3

If any portion of these regulations is declared to be invalid or ineffective in whole or in part, such decision shall not affect the validity of the remaining portions thereof. The legislative body hereby declares that they would have enacted these regulations, and each portion thereof, irrespective of the fact that any one or more portions be declared invalid or ineffective.

DEVELOPMENT DENSITY

11.4

This Area Plan has been approved by Resolution No. __ and adopted by the City Council. Approval of the Serrano Summit Area Plan includes the approval of a “Master Land Use Plan,” contained within this Area Plan. The Master Land Use Plan establishes residential Planning Areas, civic uses, open space areas, parks, and a recreation center, as well as the type, pattern, and intensity of land use within each land use area. The maximum number of residential dwelling units permitted for development is established as part of the Area Plan. This Area Plan

contains a plan for the installation of infrastructure and public improvements to serve the development and regulations and guidelines to govern land use within Serrano Summit.

DEVELOPMENT AGREEMENT

11.5

A Development Agreement between the City of Lake Forest and the Irvine Ranch Water District has been approved by the City of Lake Forest and establishes, among other things, provisions for the phasing of development and the methods of financing of construction, operation, and maintenance of public facilities, infrastructure improvements, and services for the Serrano Summit project area. The Development Agreement also establishes the plan for project compliance with local requirements for provision of parkland either through parkland dedication and/or payment of in lieu fees.

IMPLEMENTATION OF DEVELOPMENT REGULATIONS

11.6

Adoption of the development regulations as described in Section 10, “Development Regulations,” in this Area Plan shall be through a “master” Use Permit for all Serrano Summit planning areas. The requirements of this Use Permit shall take precedence over the standards contained in the City of Lake Forest Municipal Code as of the approval date of this Use Permit. In instances where the Use Permit is silent, the City of Lake Forest Zoning standards, as of the approval date of this Use Permit, shall prevail.

IMPLEMENTATION OF DESIGN GUIDELINES

11.7

Adoption of the Serrano Summit Area Plan by the City of Lake Forest includes adoption of the design guidelines contained in the Design Guidelines sections of the Area Plan, which shall be the sole design criteria by which development projects within the project area are reviewed and approved. The Design Guidelines are intended to be flexible in nature while establishing basic evaluation criteria for the review by the City of Lake Forest of development projects during Site Development Permit Review and Subdivision Review.

DEVELOPMENT REVIEW & APPROVAL PROCESS

11.8

Subdivision Maps

All development projects within Serrano Summit shall be subject to approval of subdivision maps pursuant to the requirements of Title 7 of the City of Lake Forest Municipal Code, the State Subdivision Map Act, and the Serrano Summit Area Plan. Following approval of tentative subdivision maps and final maps approved by the City, and recordation with the County of Orange, the Serrano Summit subdivision maps become the legal documentation defining development parcels and lots within the Serrano Summit boundaries. Subdivision Maps must be accompanied and processed concurrently by a Use Permit containing the development plan for the Map.

Site Development Permit

Residential detached, attached, and multi-family development projects are subject to a Site Development Permit and approval by the City's Director of Development Services, unless the Director determines that the project would benefit from a public hearing, in which case the Site Development Permit is considered by the Planning Commission. Approval of a Site Development Permit constitutes approval of site plans, conceptual architecture, and landscaping for the project.

Conditional Use Permits

All development projects subject to approval of a Conditional Use Permit (CUP) as specified in Section 10, "Development Regulations," shall be processed for approval pursuant to the provisions contained within Section 9.184.040(c), "Public Hearings," of the City of Lake Forest's Municipal Code. In accordance with the provisions of Section 9.184.040(c), an application for a CUP constitutes a discretionary application subject to approval by the City's Planning Commission. Approval of a CUP application may also be accompanied by an application for approval of a subdivision map and a Site Development Permit. Approval of a CUP constitutes approval of project architecture, site plans, and landscape plans for development.

Exceptions

Exceptions to the development regulations contained in the Serrano Summit Area Plan with respect to site area dimensions, yards and projections into yards, heights of structures, distances between buildings, open space and off-street parking and loading can also be requested using the CUP process.

MODEL HOME COMPLEX PERMIT

11.9

All model home complexes within Serrano Summit are subject to Section 9.144.070.1 of the Municipal Code and require either a Site Development Permit or a Use Permit, depending on location. Furthermore, the Municipal Code specifies time limits for model homes.

TRANSFER OF RESIDENTIAL DWELLING UNITS

11.10

The Master Land Use Plan approved as part of the Area Plan establishes the preliminary distribution and density of residential dwelling units for each residential Planning Area as well as a total number of residential dwelling units permitted for development within Serrano Summit. Adjustments to the number of residential dwelling units allocated to a Planning Area may occur at the time of final design of any portion of the Planning Area and residential dwelling units may be transferred from one residential Planning Area to another. Changes to the number of residential dwelling units among residential Planning Areas is permitted provided the maximum number of dwelling units established for the Serrano Summit project area of 608 (or 833 if the Civic Center is not constructed) is not exceeded and provided that no planning area exceeds 25 dwelling units per acre. Any requests for a transfer of dwelling units must include an analysis of other Planning Areas to ensure that the maximum densities are being adhered to. The applicable exhibits for the Area Plan will be revised as appropriate for the changes being requested.

ADJUSTMENTS TO A PLANNING AREA

11.11

Adjustments to Planning Area boundaries shall not result in any Planning Area exceeding the allowable density of 25 units per acre.

The amendment of any planning area boundary through the “B” Map process will require either the concurrent submittal of a “B” Map for any affected planning area or an amended “A” Map.

MINOR MODIFICATIONS & AREA PLAN AMENDMENTS

11.12

Minor Modifications

The following constitute minor modifications to the Area Plan, not requiring an Area Plan Amendment. The Director of Development Services shall have the discretion to refer any such request for modification to the Planning Commission for action.

1. Change in utility or public service provider.
2. Change in roadway alignment of any roadway illustrated on the “Circulation Plan” as contained within this Area Plan when the change results in a centerline shift of less than 150 feet.
3. Residential dwelling unit transfers or adjustment of a Planning Area boundary, consistent with the provisions of Sections 11.10 and 11.11 of this Area Plan.
4. Minor deviations to adopted quantifiable development standards as contained in Section 10, “Development Regulations,” of this Area Plan; provided, however, that the deviation does not result in a change of more than fifteen percent to an adopted quantifiable development standard.
5. Minor changes to landscape materials, wall materials, wall alignment, entry design, and streetscape design which are consistent with the conceptual design set forth in Section 9, “Landscape Design Guidelines,” of this Area Plan.
6. Minor changes to the design guidelines contained in Sections 7, 8, and 9 of the Area Plan, which are intended to be flexible in their implementation.

7. Other modifications of a similar nature to those listed above, which are deemed minor by the Director of Development Services, that are in keeping with the purpose and intent of the approved Area Plan, and which are in conformance with the General Plan, as amended.

Area Plan Amendments

Amendments to the Serrano Summit Area Plan may be requested by the applicant at any time. Amendments to this Area Plan shall be processed pursuant to the provisions of Section 9.184.030(b), “Area Plans,” of the City of Lake Forest Municipal Code. In the event the proposed amendment requires supplemental environmental analysis pursuant to CEQA, the entity submitting the application for an Area Plan Amendment is responsible for the costs associated with preparing the necessary CEQA documentation.

APPEALS

11.13

Appeals from any determination of the Director of Development Services or the Planning Commission may be made by any aggrieved party pursuant to the provisions of Section 2.04.100, "Appeals to City Council, of the City of Lake Forest Municipal Code.

CEQA

11.14

Compliance with Mitigation Monitoring Plan

The City of Lake Forest has certified an EIR for the Serrano Summit project. Development within Serrano Summit shall comply with all applicable mitigation measures or incorporate design features as described in the Mitigation Monitoring Program included as part of the EIR. Residential development projects, including any subdivision and any zoning change, proposed to implement this Area Plan, and which are consistent with this Area Plan, for which an EIR has been certified by the City of Lake Forest shall be considered for exemptions from the requirements of CEQA pursuant to Government Code 65457.

PROJECT FINANCING

11.15

The financing of construction, operation, and maintenance of public improvements and facilities (the “facilities”), and public services for Serrano Summit may include funding through a combination of financing mechanisms (see Exhibit 11-1, “Public Facilities Phasing & Financing Plan”). Final determination as to the facilities to be financed and as to maintenance responsibilities, whether publicly or privately maintained, will be made prior to recordation of final maps. The following financing options can be considered for implementation:

Facilities and Services

- Private capital investment for the construction of facilities.
- Community Facilities District (CFD) established pursuant to the Mello-Roos Community Facilities District Act of 1982, or other special district, to provide funding for the construction of a variety of public facilities and the provision of public services.

- Assessment Districts established for the purpose of funding the construction of public facilities.

Operation and Maintenance

- By individual private property owner.
- By Homeowners Association.
- By Landscape and Lighting Maintenance District (LLMD)
- By Community Facilities District (CFD) established pursuant to the Mello-Roos Community Facilities District Act of 1982, or other special district.
- By Assessment Districts.
- By the City of Lake Forest.

Approval by the City of Lake Forest is a prerequisite for the implementation of any and all establishment of special district and assessment district financing mechanisms.

PROJECT PHASING

11.16

Project phasing provides a conceptual framework to facilitate development of Serrano Summit while assuring the provision of infrastructure necessary to support the planned development (see Exhibit 11-2, “Development Phasing Plan”). Development is assumed to occur in a number of phases over time. Following the certification of the Serrano Summit EIR and adoption by the City of Lake Forest of the Area Plan, the phased development of Serrano Summit will commence in a manner designed to address the following objectives:

- Orderly build-out of the community based upon market and economic conditions.
- Implementation of financing mechanisms without creating a financial or administrative burden on the City of Lake Forest.
- Provision of adequate infrastructure and public facilities concurrent with development of each phase.

- Protection of public health, safety, and welfare.

The exact timing, location, and extent of individual phases is largely dependent on the private decisions of developers and landowners who are, in turn, influenced by market conditions. Phasing will also likely be influenced by relative capital costs associated with extending infrastructure and services to different phases. It is logical to assume that initial and subsequent phasing will key off of extensions of existing infrastructure located within or near the Serrano Summit boundaries.

Public and private improvements constructed as part of development of Serrano Summit shall be maintained through a combination of public and private entities as described below.

PUBLIC FACILITIES PHASING & FINANCING PLAN

EXHIBIT 11-1

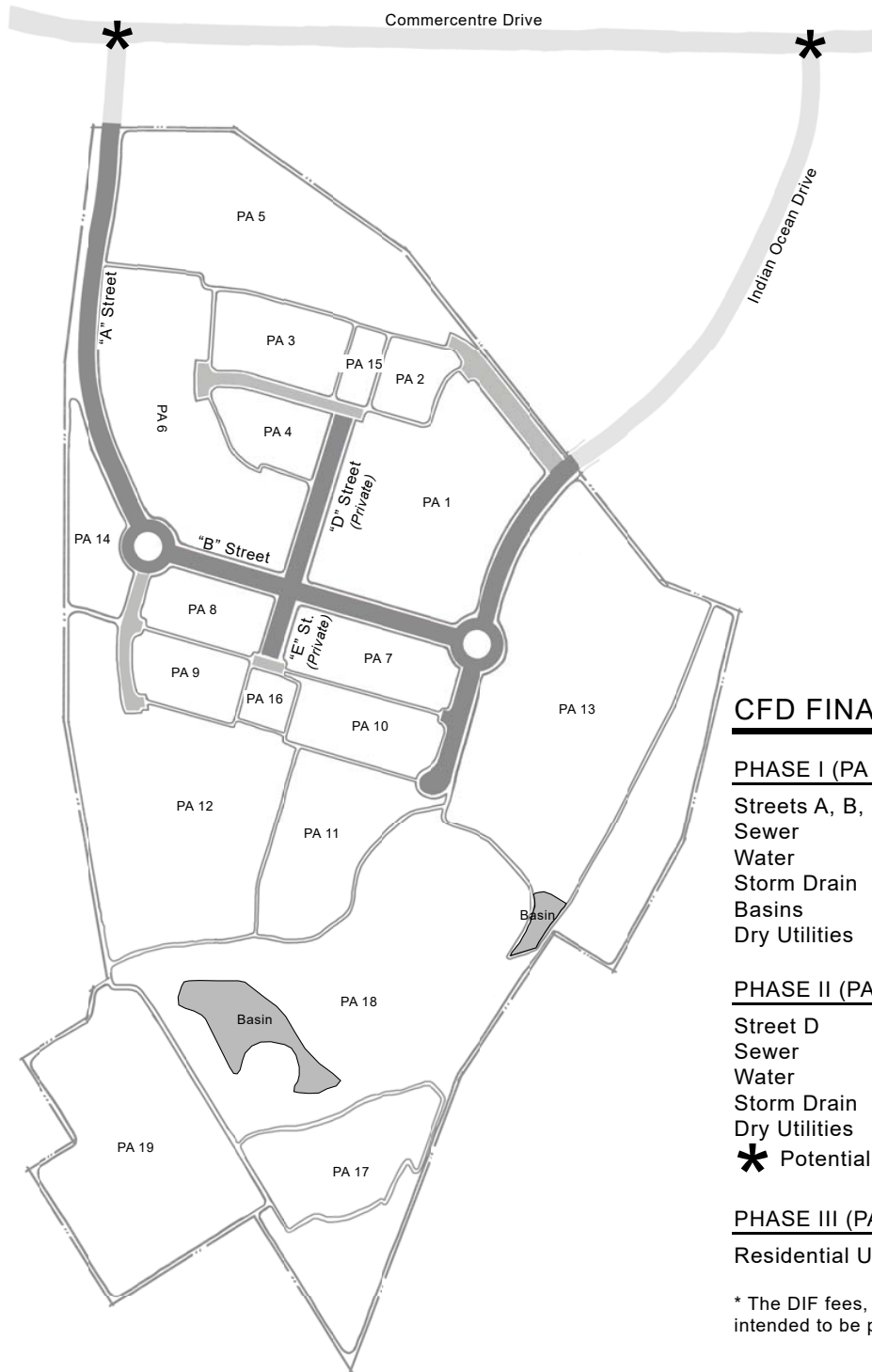

CFD FINANCING*

PHASE I (PA 7-12, 14, 16, 17)

Streets A, B, E, Indian Ocean Drive
 Sewer
 Water
 Storm Drain
 Basins
 Dry Utilities

PHASE II (PA 1-6, 15)

Street D
 Sewer
 Water
 Storm Drain
 Dry Utilities
 * Potential Traffic Signal (if needed)

PHASE III (PA 13)



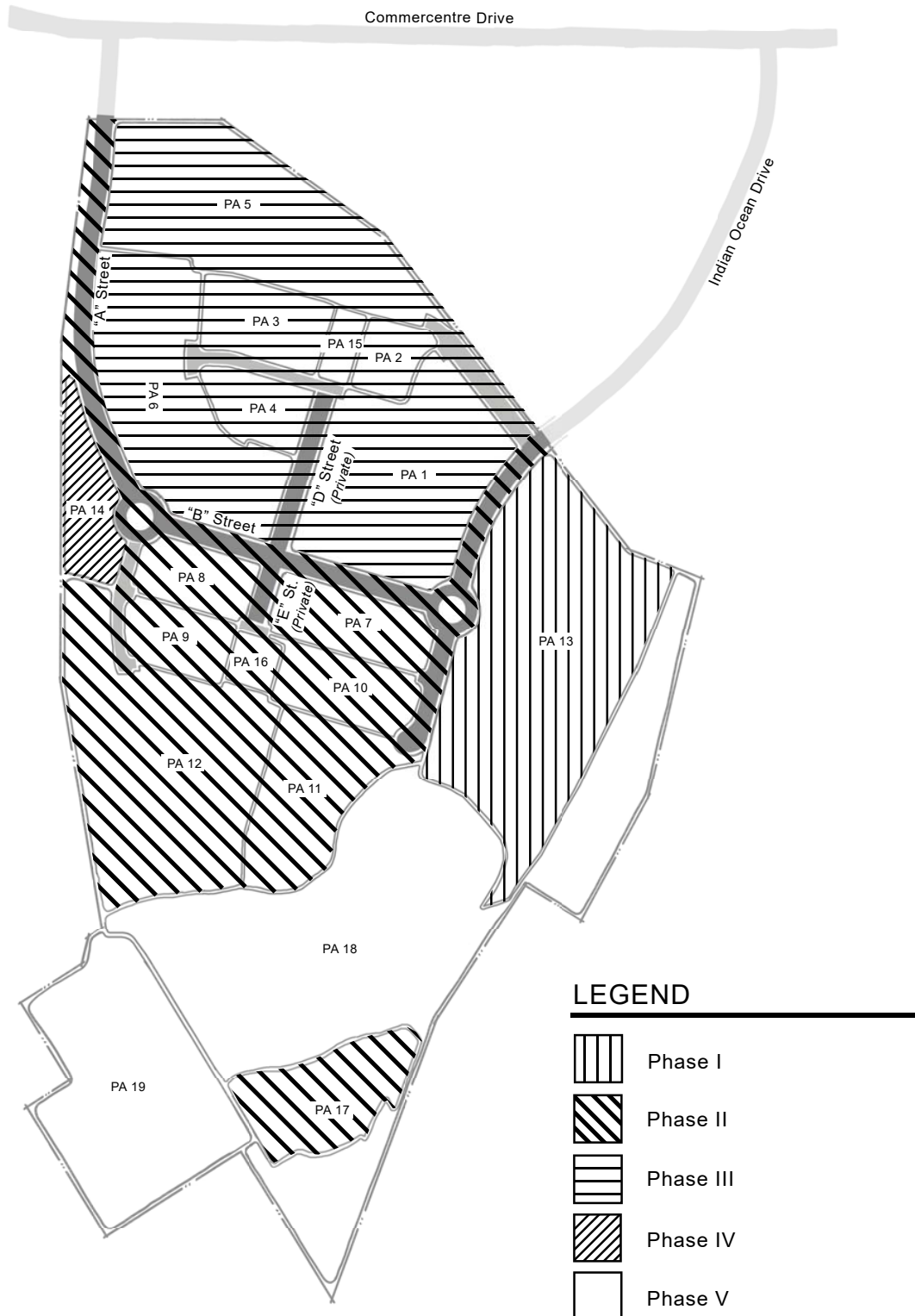

Residential Use Only

* The DIF fees, LFTM fees and school fees are also intended to be part of CFD.





LEGEND

-  Phase I
-  Phase II
-  Phase III
-  Phase IV
-  Phase V

Public Maintenance

Public facilities are planned for public maintenance by either the City of Lake Forest, a special district, or by the appropriate utility service provider including but not limited to the following:

- All travel areas of public roadways within the Serrano Summit boundaries.
- Public traffic signals and traffic control signs.
- Public rights-of-way improvements adjacent to the Serrano Summit boundaries completed as part of development within Serrano Summit.
- All privately constructed public on-site water facilities and sewer facilities within the Serrano Summit project area.
- The 3.2 acre Passive/Nature Park site on Planning Area 17 of Serrano Summit shall be dedicated to and maintained by the City of Lake Forest.
- Street lighting within public rights of way of public local streets and Collector street.
- Trails within the Civic Center site and the sidewalk on the east side parkway of Indian Ocean Drive.
- Bike paths within public roadway rights-of-way.
- Open space and facilities included within the gross acres of the Civic Center site.
- Off-site City signs.
- Civic Center detention basin.

Homeowner Association/Private Property Owner Maintenance

One or more homeowner associations may be established for the maintenance of private common area improvements within residential developments in Serrano Summit. Improvements to be maintained by the homeowner association(s) include, but are not limited to:

- Private streets, drives, lanes, and alleys.
- Private traffic control signs.
- Landscaping within the traffic roundabouts on both ends of 'B' Street.
- Median and parkway landscaping within all public streets (excluding the east side parkway of Indian Ocean Drive) and private streets (including 'D' and 'E' Streets).

- All sidewalks and trails within the community, except the trails within the Civic Center site and the east side parkway of Indian Ocean Drive.
- The two 0.5 acre Neighborhood Park sites within the Serrano Summit boundaries, along with any underground detention facilities, shall be maintained by the homeowner's association or other entity acceptable to the City of Lake Forest.
- Open space areas including graded slopes and ungraded slopes, fuel modification zones, off-street multi-purpose trails, detention and water quality treatment facilities, and habitat and restoration areas, other than the Civic Center site.
- The private recreation center in Planning Area 14.
- Private parks and recreational facilities within all residential areas.
- Sidewalks, community and neighborhood entries and signage, paseos, and common areas within residential areas.
- Community theme walls and fencing.
- Private courts, parkways, and landscaping within the residential areas.
- Storm drains.
- Community detention basins.
- Common area facing wall surfaces, and internal slopes fronting streets along residential collector streets and interior residential streets.
- Common area landscaping and lighting.
- Private street landscaping and lighting.
- Residential buildings where specified by a builder.
- Access road from Indian Ocean Drive to the Passive Park and Planning Area 19.

Refer to Table II-1, "Maintenance Responsibilities for Parks, Trails and Walkways," Exhibit 4-2, "Master Plan of Parks, Trails & Open Space," and Exhibit II-3, "Maintenance Responsibilities," for discussions of the ownership and maintenance of trails and walkways within Serrano Summit.

All applications for a development entitlement submitted after approval by the City of Lake Forest of this Area Plan shall be reviewed by the City's Planning Department for conformity with the Serrano Summit Area Plan and for compliance with

**TABLE 11-1
MAINTENANCE RESPONSIBILITIES FOR PARKS, TRAILS AND WALKWAYS**

	OWNERSHIP	MAINTENANCE
Pedestrian Sidewalk (on both sides of 'A' Street within the Serrano Summit boundaries)	Homeowners Association	Homeowners Association
Parkway Sidewalk (along both sides of 'B' Street)	Homeowners Association	Homeowners Association
Parkway Sidewalk (along both sides of Private Streets 'D' & 'E')	Homeowners Association	Homeowners Association
Parkway Sidewalk (along the east sides of Indian Ocean Drive within the Serrano Summit boundaries)	City of Lake Forest	City of Lake Forest
Parkway Sidewalk (along the west side of Indian Ocean Drive within the Serrano Summit boundaries)	Homeowners Association	Homeowners Association
Pedestrian Linkage - Trail Segment 'A' (see Exhibit 4.2 for location)	Homeowners Association	Homeowners Association
Pedestrian Linkage - Trail Segment 'B' (see Exhibit 4.2 for location)	Homeowners Association	Homeowners Association
Pedestrian Linkage - Trail Segment 'C' (see Exhibit 4.2 for location)	Ownership will be the responsibility of the City of Lake Forest if the Civic Center is built	Maintenance will be provided by the City of Lake Forest if the Civic Center is built
Pedestrian Linkage - Trail Segment 'D' (see Exhibit 4.2 for location)	Homeowners Association	Homeowners Association
Pedestrian Linkage - Trail Segment 'E' (see Exhibit 4.2 for location)	Homeowners Association	Homeowners Association
Pedestrian Linkage - Trail Segment 'F' (see Exhibit 4.2 for location)	IRWD	IRWD/City of Lake Forest
Pedestrian Linkage - Trail Segment 'G' (see Exhibit 4.2 for location)	IRWD	City of Lake Forest
Serrano Creek Trail	County of Orange	County of Orange
Access Road to Passive Park & Planning Area 19	IRWD	IRWD
2 Neighborhood Parks (Public)	City of Lake Forest	Homeowners Association
Passive/Nature Park (Public)	City of Lake Forest	City of Lake Forest

MAINTENANCE RESPONSIBILITIES

EXHIBIT 11-3

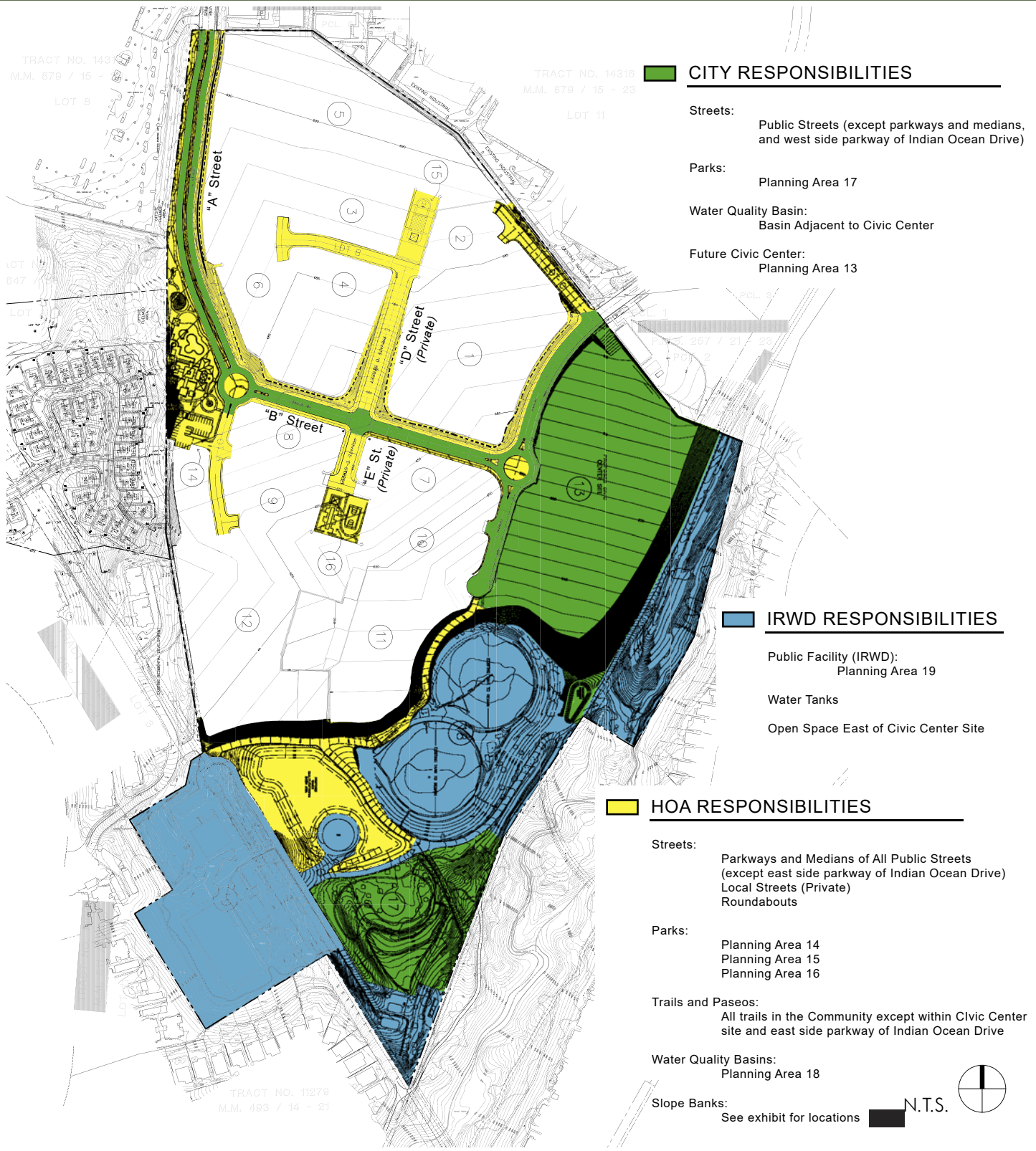

CITY RESPONSIBILITIES

- Streets:** Public Streets (except parkways and medians, and west side parkway of Indian Ocean Drive)
- Parks:** Planning Area 17
- Water Quality Basin:** Basin Adjacent to Civic Center
- Future Civic Center:** Planning Area 13

IRWD RESPONSIBILITIES

- Public Facility (IRWD):** Planning Area 19
- Water Tanks**
- Open Space East of Civic Center Site**

HOA RESPONSIBILITIES

- Streets:**
 - Parkways and Medians of All Public Streets (except east side parkway of Indian Ocean Drive)
 - Local Streets (Private)
 - Roundabouts
- Parks:**
 - Planning Area 14
 - Planning Area 15
 - Planning Area 16
- Trails and Paseos:** All trails in the Community except within Civic Center site and east side parkway of Indian Ocean Drive
- Water Quality Basins:** Planning Area 18
- Slope Banks:** See exhibit for locations ■ N.T.S.



CONFORMITY REVIEW

11.18

the California Environmental Quality Act (CEQA), Public Resources Code Section 2100 et.seq. The determination of whether the requested subsequent development entitlement is consistent with the Area Plan and whether the Serrano Summit EIR considered the project specific effects of the proposed application will be made through the Subsequent Conformity Review process.

Subsequent Conformity Review Process

In conjunction with the submittal of any application for approval of a subsequent development entitlement within the Serrano Summit boundaries, the applicant shall submit the appropriate City application to enable the City of Lake Forest to determine whether the proposed project is consistent with this Area Plan and whether or not there are project specific effects that are particular to the proposed project or its site that were not considered in the Serrano Summit EIR and whether an event as described in Section 15162 of the State CEQA Guidelines has occurred. The City of Lake Forest may require the submittal of additional information to make such a determination including, but not limited to the following:

- Preliminary Grading Plan,
- Preliminary Geotechnical Report,
- Preliminary Drainage Report,
- Preliminary Water Quality Best Management Practices (BMP) Plan,
- Traffic Circulation Plan,
- Traffic Study,
- Tentative Subdivision Map,
- Acoustical Analysis,
- Hazards Study (Phase I Environmental Site Assessments and Phase II limited soils investigation.),
- Water Quality Related Studies
- Mosquito Control Design Features,
- Utility Will Serve Letters,
- Water Supply Assessment Information (per SB 221),
- Hazardous Materials Usage Information,
- Biological and Cultural Resources Studies,
- Public Safety Assessment

In the event this project is determined to have project specific effects that were not considered in the Serrano Summit EIR and additional environmental review is required by the City of Lake Forest, the cost of preparing the additional studies or information required by the City shall be borne by the project master developer or the project applicant.

RELATIONSHIP TO THE GENERAL PLAN

Section 12.0

November 2016



AREA PLAN CONSISTENCY WITH THE GENERAL PLAN

12.1

The Serrano Summit Area Plan is consistent with the goals and policies of the adopted Lake Forest General Plan. This chapter contains an analysis of each goal and the associated policies.

Land Use Element

The relationship of the Serrano Summit Area Plan to applicable Land Use Element policies is discussed below.

Balance of Land Uses

A variety of land uses are located in Lake Forest including residential, commercial, industrial, historical, and community uses. This variety of land uses offers an important balance between the generation of public revenues and the provision of public facilities and services, and also minimizes the distances people have to travel to work, shop, and recreate.

GOAL 1.0: A balanced land use pattern that meets existing and future needs for residential, commercial, industrial, and community uses.

Policy 1.1: Achieve a land use composition in Lake Forest that promotes a balance between the generation of public revenues and the costs of providing public facilities and services.

Policy 1.2: Consider increases in development intensity up to the maximum identified in the Land Use Element where development projects provide exceptional design quality, important public amenities or public benefits, or other factors that promote important goals and policies of the General Plan.

Policy 1.3: As future conditions in surrounding areas change, the future use of land presently within the Business Development Overlay will be reviewed.

Area Plan Consistency

The Serrano Summit Area Plan provides a balanced mix of residential, recreation, open space, public facilities, and civic uses. The planned Medium

Density residential development is consistent with the site's development density range identified in the General Plan's Land Use Element. The Area Plan allows densities up to 25 dwelling units per acre and incorporates design guidelines to ensure exceptional design quality. The Area Plan also allows development of several neighborhood parks, a private recreation center, and a Civic Center complex.

Policy 1.3 does not apply to the Serrano Summit project; the project is not located with the Business Development Overlay.

Image and Identity

Lake Forest is establishing its image and identity as a distinctive, identifiable community among the communities comprising Orange County. The community possesses desirable physical qualities, including its lakes, urban forest, trees, major open space areas, accessible community facilities and well planned residential neighborhoods. A sense of arrival will be created by improving the appearance of major thoroughfares and entrances to the City.

Enhancing image and identity will create a greater sense of community and connection among the population of Lake Forest.

GOAL 2.0: A distinct image and identity for Lake Forest.

Policy 2.1: Enhance the physical attributes of Lake Forest to create an identifiable and distinct community within Orange County.

Policy 2.2: Promote high quality in the design of all public and private development projects.

Policy 2.3: Create greater City unity in the future by establishing a civic center that draws the north and south portions of Lake Forest together.

Area Plan Consistency

The Serrano Summit project includes both public and private components. The residential development would be constructed as a high quality development consisting of single-family and multi-family homes.

The project also includes a planned Civic Center on approximately 11.9 acres that will be centrally located to both the northern and southern portions of Lake Forest. The Serrano Summit project is designed to enhance the physical attributes of the project site and will be an identifiable and distinct community within both Lake Forest and Orange County.

Compatible and Complementary Development

Incompatibility can occur where the characteristics of specific land uses do not blend with the physical characteristics of available land. Locating different land uses in close proximity to one another can also result in incompatibilities associated with differences in the physical scale of development, noise levels, traffic levels, hours of operation, and other factors. Maintaining compatibility is important and reducing or avoiding incompatibilities in development is essential in improving the community's overall quality of life.

GOAL 3.0: New development that is compatible with the community.

Policy 3.1: Ensure that new development fits within the existing setting and is compatible with the physical characteristics of available land, surrounding land uses, and public infrastructure availability.

Policy 3.2: Preserve and enhance the quality of Lake Forest residential neighborhoods by avoiding or abating the intrusion of disruptive, non-conforming buildings and uses.

Policy 3.3: Ensure that the affected public agencies can provide necessary facilities and services to support the impact and intensity of development in Lake Forest and in areas adjacent to the City.

Policy 3.4: Blend residential and nonresidential development with landscaping and architectural design techniques to achieve visual compatibility.

Policy 3.5: Encourage the establishment of churches, synagogues, temples, and similar religious institutions in the community in accessible areas where compatibility with surrounding land uses can be achieved.

Policy 3.6: Work with lead agencies and adjacent jurisdictions to insure that correctional facilities are

not located or expanded in a way that conflicts with neighborhood land uses and the quality of life in the City; clearly, such facilities should not be located within close proximity to residences.

Area Plan Consistency

Serrano Summit is a new development that is designed to be compatible with surrounding land uses, as well as the physical characteristics of the project site. Because the project is an infill development, public infrastructure (e.g., roads, sewers, water, gas, electricity, telephone, etc.) is available to service the project. The project is designed to serve as a transition between the nearby office and light industrial uses along Commercentre Drive and the existing residential uses in Serrano Highlands. The project does not propose disruptive, non-conforming buildings and uses. (Policies 3.1 and 3.2)

In compliance with Policy 3.3, the project master developer will work with the affected public agencies to ensure that the necessary facilities and services to support Serrano Summit are in place and available to serve the project prior to or concurrently with project development.

Serrano Summit includes both residential and nonresidential (i.e., the Civic Center) development. This Area Plan incorporates a conceptual landscape plan, as well as architectural and landscape design guidelines that ensure quality and consistent development within the project and visual compatibility between land uses. (Policy 3.4)

Policies 3.5 and 3.6 are not applicable since neither religious institutions or correctional facilities are planned with Serrano Summit.

Economic Diversity, Expansion and Business Retention

Enhancement of City revenue is necessary to sustain the level of public services desired by the community. This can be accomplished through diversification of the community's economic base by retaining existing businesses, and by attracting additional retail and service commercial businesses, and employment generating businesses.

GOAL 5.0: Diversification and expansion of economic activities, and retention of existing businesses and revenues in support of public services.

Policy 5.1: Improve the fiscal stability of Lake Forest through retention of existing businesses, by attracting business and industry that contributes to economic growth and employment opportunities.

Policy 5.2: Work closely with the business community in developing approaches to effective business retention, economic development, and expansion of economic activities.

Policy 5.3: Focus efforts at economic development and business retention on the commercial and industrial areas throughout the City, including the Foothill Transportation Corridor, the San Diego Freeway (I-5), and along major thoroughfares.

Policy 5.4: Pursue opportunities to promote economic development and business retention using various approaches available under state and federal law.

Policy 5.5: Streamline and refine development process procedures to insure responsiveness to the business community.

Policy 5.6: Review the zoning ordinance to insure that regulations are concise and appropriate.

Policy 5.7: Preserve the fiscal well-being of the community by ensuring that land use designation changes for land within the Business Development Overlay will not result in a loss of future net revenue for the City.

Area Plan Consistency

The project will help to improve the fiscal stability of Lake Forest through the payment of impact fees and school fees (currently, the schools in the Saddleback Valley Unified School District have excess capacity). In addition, the project will provide land for a regional park and a Civic Center. (Policy 5.1)

Policies 5.2 through 5.5 and Policy 5.7 do not apply to this project as the project does not contain any existing or proposed business uses.

Regarding Policy 5.6, the Serrano Summit Area Plan includes its own concise development regulations

that have been established specifically for the Serrano Summit project.

Revitalization of Older Areas

The quality of life in the community can be substantially improved through ongoing revitalization and rehabilitation efforts aimed at improving older development in Lake Forest. These revitalization efforts will address the physical components of development including buildings, landscaping and public infrastructure.

GOAL 6.0: Revitalization of older residential, commercial, and industrial development.

Policy 6.1: Promote revitalization of identified residential neighborhoods in Lake Forest.

Policy 6.2: Promote rehabilitation of older commercial and industrial properties and buildings to enhance their quality and competitive advantage.

Area Plan Consistency

The Serrano Summit project is a new development. Therefore, Policies 6.1 and 6.2 do not apply.

CIRCULATION ELEMENT

The relationship of the Serrano Summit Area Plan to applicable Circulation Element policies is discussed below.

Intercity and Regional Transportation

Transportation in Lake Forest is directly related to an overall transportation network for the region. Planning for the needs of the community necessarily includes recognition of the related transportation needs and planning efforts of the surrounding county, region, and state. With that recognition is the need for the City to actively monitor transportation planning and development in the surrounding area.

GOAL 1.0: Support for the development of an efficient network of regional transportation facilities.

Policy 1.1: Support the completion of the Orange County Master Plan of Arterial Highways.

Policy 1.2: Work closely with adjacent jurisdictions and transportation agencies to ensure that development projects outside Lake Forest do not adversely impact the City or other providers of public facilities and services in Lake Forest.

Policy 1.3: Monitor rail travel programs including the Urban Rail System and the Commuter Rail (Metrolink) System.

Area Plan Consistency

Policies 1.1, 1.2, and 1.3 are City directives and do not apply to the Serrano Summit project.

Local Transportation Routes

Safe and convenient access to activities in the community is provided by a well designed local roadway system. That system serves the community's primary need for mobility and includes a planned hierarchy of roadways to meet that need.

GOAL 2.0: A system of roadways in the community that meets local needs.

Policy 2.1: Provide and maintain a City circulation system that is in balance with planned land uses in Lake Forest and surrounding areas in the region.

Policy 2.2: Coordinate improvements to the City circulation system with other major transportation improvement programs, such as the Foothill Circulation Phasing Plan and improvement to the San Diego Freeway (I-5).

Policy 2.3: Improve the Lake Forest circulation system roadways in concert with land development to ensure adequate levels of service.

Area Plan Consistency

The Serrano Summit project incorporates a comprehensive network of public streets, private drives, and alleys. The roadway system connects to three existing streets — Commercentre Drive, Biscayne Bay Drive and Indian Ocean Drive. The project also includes three public collector streets (i.e., 'A' Street, 'B' Street, and Indian Ocean Drive). The project will incorporate mitigation measures, as necessary and as identified in the Project EIR, to ensure adequate levels of service on area roadways.

Transit, Bicycle, Pedestrian, and Equestrian Facilities

Public transportation offers an option to the traditional use of an automobile for traveling within and outside of the community. Non vehicular methods or modes of travel, such as bicycling or walking, can reduce demands on the roadway system where appropriate facilities exist to foster those modes. Together, public transportation and non vehicular modes of travel provide important alternatives to travel by automobile.

GOAL 3.0 Increased use of public transportation.

Policy 3.1: Promote the provision of public transit facilities within areas of major development.

Policy 3.2: Encourage the provision of additional regional public transportation services and support facilities, such as park and ride lots near the San Diego Freeway (I-5) and the Foothill Transportation Corridor.

Policy 3.3: Encourage the provision of special transit services in Lake Forest.

Policy 3.4: Promote access and public transit service between Lake Forest and regional-serving transportation centers.

Area Plan Consistency

As of early 2009, the Orange County Transportation Authority (OCTA) offers a bus route (Route 480) that travels along Bake Parkway and Commercentre Drive and connects with the Irvine Station. Access to both Metrolink and Amtrak trains is available at the station. In addition, the project will pay the City LFTM fees for city-wide transportation improvements. The Serrano Summit project will also provide connections to the regional Serrano Creek trail.

GOAL 4.0: Promotion of non vehicular modes of travel.

Policy 4.1: Promote the provision of non vehicular circulation within Lake Forest.

Policy 4.2: Provide and maintain a non vehicular component of the Lake Forest overall circulation system that supports bicycles, equestrians, and

pedestrians and is coordinated with those of other service districts in Lake Forest and with adjacent jurisdictions.

Policy 4.3: Improve pedestrian access from neighborhoods to commercial areas.

Area Plan Consistency

The streets of Serrano Summit will accommodate non-vehicular circulation such as walking and cycling throughout the community. The site includes connections with the Serrano Creek Regional Trail and to other uses within the City of Lake Forest.

Parking

Convenient and well designed parking facilities are an important component of the City roadway system because they provide suitable vehicle storage areas at work, shopping, and recreation destinations. Proper parking area design can also allow for short distance travel of vehicles from one property to another without impacting the public street system.

GOAL 5.0 Convenient and suitable parking facilities for motorized and non motorized vehicles.

Policy 5.1: Require sufficient off street parking for all land uses and maximize the use of parking facilities in Lake Forest.

Policy 5.2: Eliminate the use of on street parking on identified arterial streets where maximum traffic flow is desired.

Policy 5.3: Promote the provision of access between the parking areas of adjacent properties along arterial roadways to improve overall traffic flow.

Area Plan Consistency

Serrano Summit will provide sufficient off street parking for all of the planned uses on-site. Policies 5.2 and 5.3 do not apply to the Serrano Summit project because there are no arterial streets on-site or immediately adjacent to the project site.

Transportation System and Demand Management

Transportation System Management (TSM) and Transportation Demand Management (TDM)

methods are included in an overall strategy to improve transportation. These methods can improve system effectiveness and provide relief from increasing demands for more improvements to transportation facilities.

GOAL 6.0: Maximized transportation system efficiency.

Policy 6.1: Improve operational measures of the traffic system designed to maximize the efficiency of the system while minimizing delay and congestion.

Policy 6.2: Improve intersection capacity at key intersections to improve traffic flow.

Policy 6.3: Support the implementation of employer Transportation Demand Management (TDM) provisions of the Air Quality Management Plan (AQMP) and the Congestion Management Program (CMP), and participate in regional efforts to implement TDM requirements.

Area Plan Consistency

Policies 6.1, 6.2, and 6.3 are City directives and do not apply to the Serrano Summit project.

Transportation Financing

Adequate funding must be available to finance needed improvements to the transportation system. Overall system improvements will rely upon several different sources of funding to meet the expected demands for expansion and enhancement of transportation facilities.

GOAL 7.0: Utilization of various financing methods to improve the overall transportation system.

Policy 7.1: Utilize available financing methods and sources of funding to make necessary improvements to the overall transportation system in Lake Forest.

Policy 7.2: Ensure that new development in Lake Forest associated with the Foothill Circulation Phasing Plan meets the commitments for improvements described by the Plan.

Policy 7.3: Maintain the transportation standards required to qualify for revenue from the Congestion Management Plan and the Revised Traffic

Improvement and Growth Management Ordinance (Measure M).

Area Plan Consistency

Policies 7.1, 7.2, and 7.3 are City directives and do not apply to the Serrano Summit project.

RECREATION AND RESOURCES ELEMENT

The relationship of the Serrano Summit Area Plan to applicable Recreation and Resources Element policies is discussed below.

Parks and Open Space

Lake Forest has many public parks, lakes, urban forests, and a number of the major homeowner associations operate recreational facilities for use by those living within their areas. Physical fitness, athletics, and sports are important active recreational pursuits, while facilities for passive recreational activities are also necessary. Identifying ways to best utilize, improve, and broaden the overall recreational system in the community is an important effort.

GOAL 1.0: Ample recreational and cultural opportunities and facilities.

Policy 1.1: Promote the development and maintenance of a balanced system of public and private recreational lands, facilities, and programs to meet the needs of the Lake Forest population.

Policy 1.2: Maximize the utilization of existing parks, recreational facilities, and open space within Lake Forest.

Policy 1.3: Operate and maintain public park and recreational facilities in a manner that ensures safe and convenient access for all members of the community.

Policy 1.4: Require parkland improvements and facilities that are durable and economical to maintain.

Policy 1.5: Promote a high level of public outreach regarding park and recreation opportunities in Lake Forest.

Policy 1.6: Promote the future development of community centers as focal points for local activities.

Policy 1.7: Develop a network of multi-purpose trails to provide convenient, safe access to recreational, residential, and commercial areas.

Policy 1.8: Provide a positive environment to prevent anti-social forms of behavior (gangs, graffiti, juvenile delinquency).

Policy 1.9: Preserve all designated open space areas until sufficient parkland exists in the City to meet the established parkland standard to provide adequate recreational opportunities for the community except any land within the Regional Park/Open Space designation requiring reconfiguration to create a continuous open space link.

Area Plan Consistency

The intent of Policy 1.1 is met by the Serrano Summit project by the provision of the public and private neighborhood parks on 6.1 acres, including the 1.9 acre private recreational facility in Planning Area 14. The parks will provide both active and passive recreation uses on-site. In addition, Serrano Summit will make a contribution toward a major regional park that will serve all of the City of Lake Forest.

Policy 1.2 is a City directive.

A Master Homeowners Association will be responsible for maintaining the neighborhood parks within Serrano Summit in a manner that will ensure the safe and convenient access for all members of the community.

All parkland improvements and facilities within Serrano Summit will be constructed in such a fashion as to ensure that the improvements/facilities are durable and economical to maintain. (Policies 1.3 and 1.4)

Policy 1.5 is a City directive.

A community center is an proposed as part of the Civic Center, which is an allowable use in Planning Area 13. If constructed, this center would be available for use by all residents of Lake Forest. (Policy 1.6)

In compliance with Policy 1.7, Serrano Summit is designed as a master planned community that

promotes walking and cycling. The project includes a system of pedestrian linkages that will provide connections between the various residential, civic, open space, and recreational uses.

In accordance with Policy 1.8, the Serrano Summit community is designed to provide a positive environment that will help to minimize and prevent anti-social forms of behavior.

Policy 1.9 is a City directive.

Natural Resources and Features

Lake Forest contains many important natural resources and features, including its eucalyptus forest and other trees, lakes, creeks, canyons, hillsides, mineral resource areas, and other open lands. These resources add to the value of property, provide visual changes in an urban environment that create interest, and offer important landmarks that communicate a sense of place and location within the community. These important resources can be preserved or enhanced to maintain the natural physical and visual quality of Lake Forest.

GOAL 2.0: Preservation and enhancement of important natural resources and features.

Policy 2.1: Conserve and protect important natural plant and animal communities, such as areas supporting rare and endangered species, riparian areas, wildlife movement corridors, wetlands, and significant tree stands through appropriate site planning and grading techniques, re-vegetation and soil management practices, and other resource management techniques.

Policy 2.2: Coordinate water quality and supply programs with the responsible water agencies.

Policy 2.3: Encourage the expansion of reclaimed water production and use.

Policy 2.4: Conserve and protect important topographical features, watershed areas, and soils through appropriate site planning and grading techniques, re-vegetation and soil management practices, and other resource management techniques.

Area Plan Consistency

The project will preserve the drainage along Serrano Creek in open space. No rare or endangered species have been identified on the project site. In addition, no significant tree stands exist on-site.

As part of the required actions associated with development of the Serrano Summit project, the project owner/master developer (which is the Irvine Ranch Water District) will promote water quality and supply programs that include the Serrano Summit project to the extent feasible. In addition, the project will incorporate the use of reclaimed water for irrigation purposes.

This Area Plan includes a conceptual grading plan designed to conserve and protect important topographical features, watershed areas, and soils through appropriate site planning and grading techniques. The grading plan requires re-vegetation and irrigation of manufactured slopes and implementation of soil management practices and other resource management techniques, as appropriate.

GOAL 3.0: Extraction of mineral resources and reclamation of mined land, while preserving the City's plans for future use as described in the Land Use Element.

Policy 3.1: Provide for the conservation and development of significant identified mineral resource sites within Lake Forest.

Policy 3.2: Provide for the reclamation of mineral resource sites in concert with future use as described in the Land Use Element and required environmental mitigation.

Policy 3.3: Regulate mineral extraction activities to minimize hazards and conflicts with other land uses by the issuance of sand and gravel site permits.

Policy 3.4: Address and mitigate the significant environmental effects of surface mining operations.

Policy 3.5: Promote land use decisions that ensure, to the greatest extent possible, compatibility between mineral resource extraction and adjacent land uses.

Area Plan Consistency

No significant mineral resources have been identified on the Serrano Summit project site. Therefore, Policies 3.1 through 3.5 do not apply to the project.

Historic, Archaeological, and Paleontologic Resources

Lake Forest contains several important historic, archaeological, and paleontologic resources and potential resource areas that should be conserved to provide a link to the community's history and heritage. Conservation of these resources and investigation of potential resource areas represents an important undertaking for connection with the community's past.

GOAL 4.0: Conservation of important historic, archaeological, and paleontologic resources.

Policy 4.1: Protect areas of important historic, archaeological, and paleontologic resources.

Policy 4.2: Identify, designate, and protect buildings or sites of historical significance.

Area Plan Consistency

The project site does not contain any areas or sites of historic, archaeological or paleontologic importance. Therefore, Policies 4.1 and 4.2 do not apply to the Serrano Summit project.

Human Resources

Lake Forest has many homeowner associations, community groups, and business groups, which represent important resources for accomplishing long term community goals. These groups often include volunteer leaders and workers who have a distinct understanding of their neighborhoods and areas. These significant human resources may be used to establish and achieve community goals.

GOAL 5.0: Active citizen involvement to establish and achieve community goals.

Policy 5.1: Solicit citizen participation during the early stages of major public or private development projects and regulatory programs.

Policy 5.2: Utilize homeowner associations, community groups, and business groups as sources

of individual volunteers for important appointed positions on City commissions, boards, and task forces.

Policy 5.3: Develop appropriate vehicles, such as newsletters, information brochures, cable television programming and announcements, and other methods, to communicate important information to the population of Lake Forest.

Area Plan Consistency

Citizen participation has been encouraged as part of the entitlement process for the Serrano Summit Area Plan. This participation included several stakeholder meetings.

Policy 5.2 is a City direction and does not apply on a project-level to the Serrano Summit community.

Policy 5.3: Develop appropriate vehicles, such as newsletters, information brochures, cable television programming and announcements, and other methods, to communicate important information to the population of Lake Forest.

Solid Waste

To maintain the long term quality of life in Lake Forest, the community must manage the generation, use, and disposal of solid waste. Recycling, reuse and reduction of solid waste, including landscaping refuse, can dramatically reduce the amount of material that will otherwise use expensive land fill space.

GOAL 6.0: Reduction of the per capita volume of solid waste produced in the community.

Policy 6.1: Reduce the per capita production of solid waste in Lake Forest in concert with the County of Orange source reduction and recycling plans for reducing solid waste.

Area Plan Consistency

Policy 6.1 is a City directive. The Serrano Summit project will comply with waste reduction requirements instituted by the City of Lake Forest and the County of Orange, as applicable.

Air Quality

Air quality within the South Coast air basin does not presently meet state and federal standards.

Cooperation among all agencies in the basin is necessary to achieve desired improvements to air quality. Lake Forest can participate and contribute its share in those efforts by proper planning for land use, transportation and energy use.

GOAL 7.0: Improvement of air quality.

Policy 7.1: Cooperate with the South Coast Air Quality Management District and Southern California Association of Governments in their efforts to implement the regional Air Quality Management Plan.

Policy 7.2: Cooperate and participate in regional air quality management planning, programs and enforcement measures.

Policy 7.3: Utilize transportation demand management to influence transportation choices related to mode and time of travel.

Policy 7.4: Implement Citywide traffic flow improvements

Policy 7.5: Implement land use policy aimed at achieving a greater balance between jobs and housing in Lake Forest.

Policy 7.6: Integrate air quality planning with land use and transportation planning.

Policy 7.7: Promote energy conservation and recycling by the public and private sector in Lake Forest.

Area Plan Consistency

Policies 7.1 through 7.6 are City directives that apply on a city-wide or regional level. The Serrano Summit Area Plan implements Policy 7.7 by incorporating energy conservation design features into the project and by encouraging energy conservation and recycling by new developments. Additionally, the community promotes walking and bicycling that will reduce vehicular usage and cut down on vehicle emissions. Serrano Summit will pay LFTM fees to the City for regional transportation improvements. Other features incorporated into the project to help minimize air quality impacts include a requirement that only gas fireplaces be provided on-site.

PUBLIC FACILITIES/GROWTH MANAGEMENT ELEMENT

Water and Sewer Service

Water and sewer service is an essential component of the infrastructure needed to support urban development. These services are provided by several special service districts including the El Toro Water District, the Trabuco Canyon Water District and the Irvine Ranch Water District.

GOAL 1.0: Effective coordination with local water and sewer service districts.

Policy 1.1: Work closely with local water and sewer districts in determining and meeting community needs for water and sewer service.

Area Plan Consistency

This Area Plan requires that the project master developer work closely with the local water and sewer district (Irvine Ranch Water District) to determine and meet the Serrano Summit community's needs for water and sewer service. The water conservation plan for the Serrano Summit community features water-wise plantings and landscaping, water-conserving irrigation techniques, and low flow toilets and showerheads.

Natural Gas, Electricity, and Communications

Natural gas is provided by the Southern California Gas Company, electricity is provided by Southern California Edison, telephone service is provided by Pacific Bell, and cable television service is provided by Cox Communications. These sources of energy and communication are necessary to support existing and future development in the community.

GOAL 2.0: Effective coordination with providers of natural gas, electricity, telephone and cable television service.

Policy 2.1: Work closely with local providers of energy and communications in determining and meeting community needs for energy and communications, and to underground overhead transmission facilities.

Area Plan Consistency

In compliance with Policy 2.1, development of the Serrano Summit project will involve close coordination with local providers of natural gas, electricity, telephone, and cable television service. AH

Fire Protection and Law Enforcement

Fire protection is provided by Orange County Fire and law enforcement is provided by the Orange County Sheriffs Department. Both services are essential to the safety of the population of Lake Forest.

GOAL 3.0: Effective coordination with Orange County Fire and Orange County Sheriffs Department.

Policy 3.1: Work closely with Orange County Fire and the Orange County Sheriffs Department in determining and meeting community needs for safety facilities and services.

Policy 3.2: Periodically evaluate level of service to ensure that Lake Forest has appropriate levels of fire, police and emergency medical services.

Area Plan Consistency

This Specific Plan includes a Fuel Modification Plan in Section 9 that will help to reduce fire risk in the Serrano Summit community. In addition, the Serrano Summit project will pay the required fees to ensure that adequate levels of fire and police protection and emergency medical services are available to the community. Also, the Civic Center complex, if built by the City of Lake Forest, may include a new sheriff's station.

An Environmental Impact Report (EIR) has been prepared for the project analyzing potential impacts from fire hazards associated with development of the project. The EIR includes mitigation measures needed to address any identified impacts. The community of Serrano Summit is not located within a high fire hazard zone.

Flood Control

Flood control facilities and maintenance are provided by Orange County Flood Control District and the City of Lake Forest. Flood control is another essential

safety service necessary to ensure the desired quality of life in the community.

GOAL 4.0: Effective coordination with the Orange County Flood Control District.

Policy 4.1: Work closely with the Orange County Flood Control District in determining and meeting community needs for flood control facilities and maintenance.

Area Plan Consistency

The Serrano Summit Area Plan incorporates design features designed to address flood control facilities and maintenance. The project also incorporates WQMP basins and detention basins to ensure that build-out of Serrano Summit will not increase flows into Serrano Creek.

Libraries

Libraries and library service are provided by the Orange County Library system. The availability of reading and reference material to all members of the community is an important measure of the quality of life in Lake Forest.

GOAL 5.0: Effective coordination with the Orange County Library.

Policy 5.1: Work closely with the Orange County Library in determining and meeting community needs for library facilities and services, including hours of operation.

Area Plan Consistency

Policy 5.1 is a City directive and involves action by the City of Lake Forest.

Schools

Public education is a valued resource provided by the Saddleback Valley Unified School District in Lake Forest. The community benefits greatly from the quality of its public schools and the opportunities for joint use of City and School District facilities.

GOAL 6.0: Effective coordination with the Saddleback Valley Unified School District.

Policy 6.1: Work closely with the Saddleback Valley Unified School District in determining and meeting

community needs for public education and related activities.

Area Plan Consistency

The project will make its fair-share contribution of school fees to the School District. Currently, the schools in the vicinity of the Serrano Summit community have excess capacity.

Transportation

Many of the regional transportation facilities are not adequately sized to accommodate existing and projected growth. In response to this situation, Orange County voter approved a measure (Measure M) in 1990 and the Foothill Corridor Phasing Plan (FCPP) to allocate additional funds, to provide needed transportation facilities.

GOAL 7.0: Adequate transportation facilities for the population of Lake Forest.

Policy 7.1: Work closely with the County of Orange, Caltrans, surrounding jurisdictions, and other transportation agencies to provide needed transportation facilities.

Area Plan Consistency

Policy 7.1 is a City directive and involves action by the City of Lake Forest in cooperation with the County of Orange, Caltrans, surrounding jurisdictions, and other transportation agencies to provide needed transportation facilities. The Serrano Summit project will be responsible for paying FCPP fees.

Jobs Housing Balance

Creating communities where people can both live and work in relatively close proximity shortens commuting and encourages the use of alternative forms of transportation to and from work. This can reduce overall traffic congestion and improve regional air quality.

GOAL 8.0: Balance between jobs and housing in Lake Forest.

Policy 8.1: Utilize information on the jobs/housing balance in the City and region as a factor in land use decision-making.

Area Plan Consistency

Policy 8.1 is a City directive and involves action by the City of Lake Forest.

Interjurisdictional Coordination and Cooperation

Lake Forest is one of 33 cities in Orange County and many of the issues and opportunities facing the community can only be resolved through mutually cooperative efforts. Planning for solid waste disposal and recycling, air quality improvement, and transportation are a few examples of issues that lend themselves to cooperative solutions.

GOAL 9.0: Effective coordination and cooperation with other public agencies to address regional issues and opportunities.

Policy 9.1: Participate with other public agencies in cooperative efforts to address important regional issues.

Policy 9.2: Monitor major new developments proposed in adjacent communities to ensure that impacts on Lake Forest are mitigated.

Area Plan Consistency

Policies 9.1 and 9.2 are City directives and involve regional issues.

SAFETY AND NOISE ELEMENT

Natural Hazards and Human Activity Hazards

The risk associated with certain natural hazards, such as geologic conditions, seismic activity, fire and flooding can be minimized through appropriate planning and preparedness actions. The risk of exposure to such hazards can be reduced to acceptable levels through proper development engineering and building practices. Certain human activities, such as flying, use of hazardous or toxic materials, use of combustibles, and criminal actions can expose the population risk. The risk of exposure to hazards associated with human activity can be reduced to acceptable levels through proper planning and regulation of human activities.

GOAL 1.0: Reduction in the risk to the community from hazards associated with geologic conditions, seismic activity and flooding.

Policy 1.1: Reduce the risk of impacts from geologic and seismic hazards.

Policy 1.2: Protect the community from flooding hazards.

Area Plan Consistency

Development within Serrano Summit will be consistent with all State of California building and construction codes pertaining to seismic safety. An Environmental Impact Report has been prepared for the project analyzing seismic and geologic hazards surrounding and within the Serrano Summit boundaries, the potential impacts to structures within the project area, and the seismic safety measures proposed as part of the project. The EIR will include mitigations to address any identified potentially significant impacts.

This Area Plan identifies a series of drainage and flood control improvements intended to minimize the risk of flooding on-site and to areas downstream of the project site.

GOAL 2.0: Protection of the community from hazards associated with aircraft overflights, hazardous materials use, fire, and ground transportation.

Policy 2.1 : Reduce the risk to the community from aircraft overflights.

Policy 2.2: Reduce the risk to the community from the use and transport of hazardous materials.

Policy 2.3: Reduce the per capita production of household hazardous waste in Lake Forest in concert with the County of Orange plans for reducing hazardous waste.

Policy 2.4: Reduce the risk to the community from fire.

Policy 2.5: Reduce the risk from ground transportation hazards, such as rail and roadway systems.

Area Plan Consistency

Policies 2.1, 2.2, and 2.3 are City directives that require action by the City of Lake Forest.

The Serrano Summit Area Plan includes a fuel modification plan that will implement Policy 2.4 and reduce the fire risk to the community.

The project incorporates two roundabouts as traffic calming devices to help slow down the speed of traffic and reduce potential risks to the community arising from ground transportation hazards, such as the roadway system.

GOAL 3.0 Protection of citizens and businesses from criminal activity.

Policy 3.1: Provide substantive levels of police protection.

Policy 3.2: Improve public awareness of ways to reduce criminal activity and Orange County Sheriffs Department responsiveness (Neighborhood Watch, improved communication and education methods).

Policy 3.3: Provide an effective approach to reduce graffiti.

Area Plan Consistency

Policies 3.1, 3.2, and 3.3 are City directives and require action by the City of Lake Forest.

Emergency Preparedness

Proper preparation for major emergencies is an essential action to minimize the disruption, personal injury, and property damage associated with such events. Preventative measures and preparatory responses before an emergency occurs will hasten recovery from these emergencies.

GOAL 4.0: Improved ability of the City to respond to natural and human-related emergencies.

Policy 4.1: Support the development of local preparedness plans and multi-jurisdictional cooperation and communication for emergency situations.

Policy 4.2: Educate residents and businesses regarding appropriate actions to safeguard life and property during and immediately after emergencies.

Area Plan Consistency

Policies 4.1 and 4.2 are City directives and involve action by the City of Lake Forest.

Noise and Land Use Planning

Certain portions of the planning area are subject to high noise levels. The consideration of the sources and recipients of noise early in the land use planning process is an effective method of minimizing the impacts of noise on the community's population. Areas already impacted by noise can also have noise reduced through rehabilitative improvements.

GOAL 5.0: Consideration of the effects of noise in land use planning.

Policy 5.1: Utilize noise/land use compatibility standards as a guide for future planning and development decisions.

Policy 5.2: Provide noise control measures, such as berms, walls, and sound attenuating construction in areas of new construction or rehabilitation.

Area Plan Consistency

The EIR that was prepared for Serrano Summit incorporates noise mitigation measures, such as berms, walls, and sound attenuating construction, as needed to mitigate potential impacts from noise sources to below a level of significance.

Transportation Noise

Transportation-related noise is a primary factor affecting the overall quality of life for much of Lake Forest. Reduction of transportation-related noise is an effective approach to dealing with the detrimental effects attributable to excessive noise levels.

GOAL 6.0: Reduction in the impact of transportation-related noise.

Policy 6.1: Reduce noise impacts to sensitive land uses from transportation noise sources.

Area Plan Consistency

The EIR that was prepared for Serrano Summit incorporates noise mitigation measures as needed to mitigate potential impacts from transportation noise sources to below a level of significance.

Non-Transportation Noise

Noise sources that are not directly related to transportation include construction noise, manufacturing noise, and property maintenance activities. Such noise sources may be controlled to minimize any exposure to excessive noise levels.

GOAL 7.0: Reduction in non-transportation noise impacts.

Policy 7.1: Minimize the impacts of noise-producing land uses and activities on noise-sensitive land uses.

Area Plan Consistency

The EIR that was prepared for Serrano Summit incorporates noise mitigation measures as needed to mitigate potential impacts from noise-producing land uses to below a level of significance.

ARCHITECTURAL STYLE SHEETS

Appendix

November 2016



AN INTRODUCTION TO ARCHITECTURAL STYLES

The Architectural Style Sheets provided in this section should be used in conjunction with the residential design guidelines in Section 7.0 to guide home design. The massing, character, and detailing of the architectural styles should be as consistent with the selected styles as feasible. However, the style sheets may be used with flexibility to allow contemporary adaptations of traditional vernaculars. Architects and designers are encouraged to exercise creativity and individual expression in conceiving and interpreting architectural form.

Furthermore, architectural styles should be honest and appropriate for the building typology. Where feasible, the choice of architectural expression should be derived from the respective building typology (i.e., row towns, courtyard buildings, single family homes, etc.).

MONTEREY

The original Monterey style emerged in the mid-nineteenth century with Americans arriving from the east coast. The original style combined the two-story New England colonial house with an Adobe brick exterior. Later, the Monterey style was merged with elements from the Spanish Eclectic and Colonial Revival styles. Regardless of this evolution, the defining features of the Monterey style are the unique blend Spanish Colonial materials and the New England massing and a prominent second-story balcony, cantilevered along the front of the house and covered by the principal roof.

Appropriate Building Typologies

Single Family Detached Residential, Single Family Detached Enclave Residential, Single Family Attached Residential, Multi-Family Attached Residential

California Series



Wide Balcony and Covered Porch

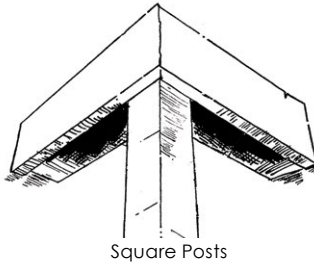

Square Posts

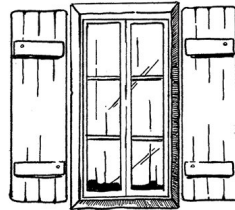

Board and Batten Shutters



Pedimented Entry

ELEMENTS	MINIMUM STANDARDS	ENCOURAGED ENHANCEMENTS
FORM	<ul style="list-style-type: none"> ◦ Rectilinear plan form ◦ Symmetrical ◦ Front balcony integral to plan form (could be cantilevered or with posts extending to the ground plane) 	<ul style="list-style-type: none"> ◦ Simple plan with one story break or gable ◦ Front-facing balcony over porch
ROOF	<ul style="list-style-type: none"> ◦ Main front-to-back gable roof ◦ 4:12 to 5:12 primary roof pitch ◦ 12" to 24" overhangs ◦ "S"-shape concrete or flat concrete tiles 	<ul style="list-style-type: none"> ◦ Main gable roof front to back with intersecting gable ◦ Shed roof break over balcony with 4:12 to 5:12 roof pitch ◦ Exposed rafter tails
WALLS	<ul style="list-style-type: none"> ◦ Stucco 	<ul style="list-style-type: none"> ◦ Brick or slump block accents at base ◦ Vertical siding accents on second story
WINDOWS	<ul style="list-style-type: none"> ◦ Windows with inserts on elevations with prominent and moderate public visibility ◦ Window trim surrounds proportionate to window size 	<ul style="list-style-type: none"> ◦ Enhanced window and door trim ◦ Recessed accent windows ◦ Layered trim at doors and windows ◦ Shutters on primary windows
DETAILS	<ul style="list-style-type: none"> ◦ Wood or wood-like balcony with square posts and simple railing ◦ Entry door patterns should reflect architectural style of the building 	<ul style="list-style-type: none"> ◦ Brackets ◦ Pedimented entry or simple entry located under second story balcony ◦ Decorative wrought iron accents

SANTA BARBARA

White-washed stucco walls are inherent to the Santa Barbara style, which also features boxy, simple forms, low-pitched gable roof form, and the use of wood and tile as accent details.

Appropriate Building Typologies

Single Family Detached Residential, Single Family Detached Enclave Residential, Single Family Attached Residential, Multi-Family Attached Residential

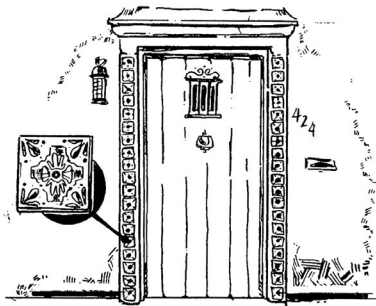

Decorative Tile

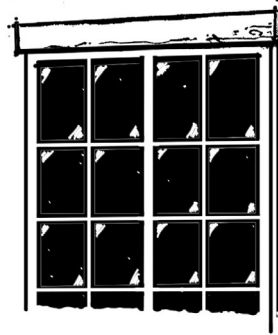

Window Headers



Arches and Arcades



Balcony

ELEMENTS	MINIMUM STANDARDS	ENCOURAGED ENHANCEMENTS
FORM	<ul style="list-style-type: none"> ◦ Boxy, simple massing ◦ One- and two-story stacked elements ◦ Recessed entry or covered porch 	
ROOF	<ul style="list-style-type: none"> ◦ Hip or intersecting gable roof ◦ 4:12 to 5:12 primary roof pitch ◦ 0" to 12" overhang ◦ "S"-shape concrete tiles ◦ Minimal breaks in roof form 	<ul style="list-style-type: none"> ◦ Semi-tight rake at gable ends
WALLS	<ul style="list-style-type: none"> ◦ Stucco with light sand finish 	
WINDOWS	<ul style="list-style-type: none"> ◦ Vertical windows with inserts on elevations with prominent and moderate public visibility ◦ Accent recessed windows 	<ul style="list-style-type: none"> ◦ Wood or wood-like window headers ◦ Focal window
DETAILS	<ul style="list-style-type: none"> ◦ Simple door trim ◦ Arches and arcades ◦ Decorative wrought iron accent details 	<ul style="list-style-type: none"> ◦ Decorative tiles ◦ Exposed wood or wood-like beams

SPANISH COLONIAL

Key elements of this style utilize decorative details borrowed from historic Spanish architecture, informal plan forms, simply detailed elevations, including an identifiable feature window on the front elevation, as well as the use of arches, and other historic Spanish vernacular elements.

Appropriate Building Typologies

Single Family Detached Residential, Single Family Detached Enclave Residential, Single Family Attached Residential, Multi-Family Attached Residential

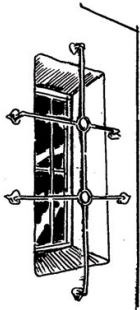

Decorative Wrought Iron



Arches and Arcades

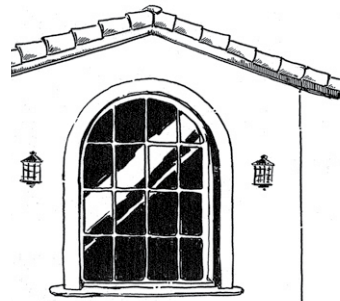

Feature Window

ELEMENTS	MINIMUM STANDARDS	ENCOURAGED ENHANCEMENTS
FORM	<ul style="list-style-type: none"> One- and two-story massing 	<ul style="list-style-type: none"> Two-story massing with one-story element
ROOF	<ul style="list-style-type: none"> Simple hip or gable roof intersecting gable 4:12 to 5:12 primary roof pitch 0" to 12" overhang with tight rake on gable ends "S"-shape concrete tiles 	<ul style="list-style-type: none"> Shed roof over porch Shaped rafter tails at feature areas Barrel or Mission style concrete tiles
WALLS	<ul style="list-style-type: none"> Stucco with light sand finish 	
WINDOWS	<ul style="list-style-type: none"> Windows with inserts on elevations with prominent and moderate public visibility Window trim surrounds proportionate to window size 	<ul style="list-style-type: none"> Feature window on front elevation Recessed window Single or grouped round top windows Shutters on front elevation windows
DETAILS	<ul style="list-style-type: none"> Pipe vents Arched column porches Simple door trim proportionate to door size Entry door patterns should reflect architectural style of the building 	<ul style="list-style-type: none"> Arches or arcades Wrought iron or wood-like balconies Decorative wrought iron accent details Decorative tile Stucco or decorative vents Front courtyards or enclosed patios Round or octagonal feature at corner entries Sculptured wing walls

AN INTRODUCTION TO THE REVIVAL STYLE

The unique spirit of California is a result of its confluence of history, people, lifestyles, and natural environments. This region is remarkable for its cultural diversity and mild climate, providing an amazingly rich variety of opportunities to live and flourish. Consistent with this theme has been the evolution of the region's architecture, encompassing virtually every style and construction technique, while reinterpreting to the locale but retaining the essential characteristics of its origin.

Southern California residential communities of the 1920's and 1930's captured this aesthetic particularly well, translating its mix of people and ideas into an architecture of variety and comfort. While these communities can be said to have no single ancestral style, they exhibit an adaptation and re-interpretation of a number of appropriate historic styles which were transplanted from other places. This form of architectural expression can be loosely referred to as "revival" - a stylistic redefinition fitting a particular place and purpose, but retaining the romance of its original roots while free of the associations with its cultural idioms.

Examples of this vernacular can be found throughout areas of the Southland - from central Los Angeles to the foothills of Pasadena, and to the outlying suburban reaches of Claremont and Fullerton - which flourished during the early 20th century. While lacking the reputation and cachet of the more affluent boroughs of Hancock Park and Beverly Hills, they nonetheless represent superb examples of the creativity, variety, imagination and enduring charm of Southern California's "golden age" of revival architecture.

ADOBE RANCH - REVIVAL SERIES

The Adobe Ranch architectural style emerged as an update and adaptation of the Spanish Ranchos built throughout the 19th century in California. Although originally constructed from adobe, conventional materials introduced with modern building practices have created an indigenous California version of the style; one that is evocative yet low in profile. Detail elements typical of this style include painted brick or stone detailing, stucco chimney forms, buttresses, and long porches. Wall mass is expressed using recessed windows and other architectural details.

Appropriate Building Typologies

Single Family Detached Residential, Single Family Detached Enclave Residential, Single Family Attached Residential, Multi-Family Attached Residential

Revival Series

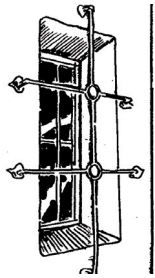

Ornamental Wrought Iron

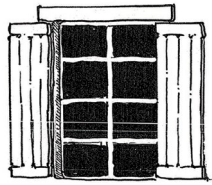

Divided Window with Header and Shutters



Arches and Arcades

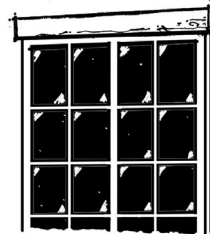

Wood Window Header

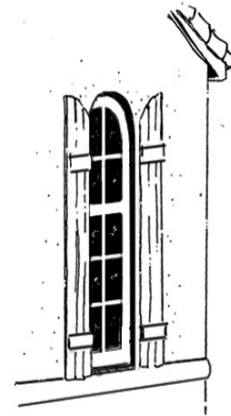

Recessed Window with Shutters

ELEMENTS	MINIMUM STANDARDS	ENCOURAGED ENHANCEMENTS
FORM	<ul style="list-style-type: none"> Simple, often "L"-shaped, rectangular two-story massing 	<ul style="list-style-type: none"> Single-story element, such as covered porch
ROOF	<ul style="list-style-type: none"> Gable and shed roof forms 4:12 to 5:12 primary roof pitch Flat concrete and barrel "S"-shape concrete tiles 	<ul style="list-style-type: none"> Semi-flush or stucco-wrapped rakes Exposed rafter tails
WALLS	<ul style="list-style-type: none"> Stucco with light sand finish 	<ul style="list-style-type: none"> Painted brick or stone use
WINDOWS	<ul style="list-style-type: none"> Windows with inserts on elevations with prominent and moderate public visibility Wood header or stucco trim surrounds 	<ul style="list-style-type: none"> Recessed windows with shutters
DETAILS	<ul style="list-style-type: none"> Covered entry stoop Stucco "low wall" pot shelf on first story 	<ul style="list-style-type: none"> Ornamental wrought iron Arches and arcades Heavy square stucco columns Flat paver sill elements

SPANISH COLONIAL - REVIVAL SERIES

The Spanish Colonial Revival style combines a wide source of elements derived from earlier related styles (adobe Spanish Colonial, Mission, Moorish, and the Baroque architecture of Colonial Spain and Portugal) while responding to a more modern-day context. This regional expression combines the basic forms of traditional Spanish architecture with local styles prevalent at the time such as Mission and Arts and Crafts. Some distinguishing features include plaster walls, chimneys with distinctive hoods, low-pitched tile roofs, and decorative wrought iron window grills. Patterned tile, terra-cotta pavers, finials and wood decks or balconies were also employed to add color, texture, and accent.

Appropriate Building Typologies

Single Family Detached Residential, Single Family Detached Enclave Residential, Single Family Attached Residential, Multi-Family Attached Residential

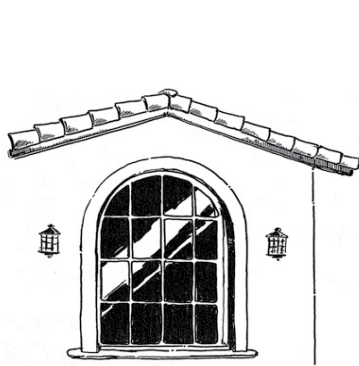

Arch-Top Feature Window

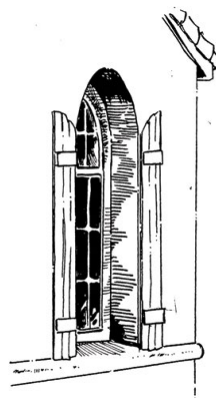

Plank Shutters

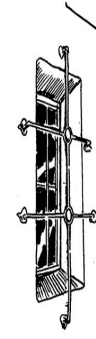

Wrought Iron Over Windows

Revival Series

ELEMENTS	MINIMUM STANDARDS	ENCOURAGED ENHANCEMENTS
FORM	<ul style="list-style-type: none"> One- and two-story volumes 	<ul style="list-style-type: none"> Turrets 12" to 18" second-floor cantilevers
ROOF	<ul style="list-style-type: none"> Gable and shed roof forms 4:12 to 5:12 primary roof pitch Barrel "S"-shape concrete tiles 	<ul style="list-style-type: none"> Cut rafter tails Flush rakes Profile eaves
WALLS	<ul style="list-style-type: none"> Stucco with light sand finish 	<ul style="list-style-type: none"> Rounded wall return to windows and doors
WINDOWS	<ul style="list-style-type: none"> Wood or stucco trim surrounds Windows with inserts on elevations with prominent and moderate public visibility 	<ul style="list-style-type: none"> Plank or panel shutters Arch-top feature windows
DETAILS	<ul style="list-style-type: none"> Entry door patterns to complement style Recessed, articulated entry 	<ul style="list-style-type: none"> Wrought iron over windows Juliet balconies Finials Wood decks

